



UC4-13341

UC4

ULTRASONIC SENSORS

SICK
Sensor Intelligence.



Ordering information

Type	Part no.
UC4-13341	6034669

Other models and accessories → www.sick.com/UC4



Detailed technical data

Mechanics/electronics

Supply voltage V_s	DC 15 V ... 30 V ¹⁾
Power consumption	≤ 0.75 W ²⁾
Initialization time	< 300 ms
Design	Rectangular
Housing material	Plastic (ABS) Ultrasonic transducer: polyurethane foam, glass epoxy resin
Connection type	Male connector, M8, 3-pin
Indication	2 x LED
Weight	10 g
Sending axis	Straight
Dimensions (W x H x D)	16 mm x 40.1 mm x 16.7 mm
Enclosure rating	IP65 / IP67
Protection class	III

¹⁾ Limit values, reverse-polarity protected, operation in short-circuit protected network: max. 8 A.

²⁾ Without load.

Performance

Operating range, limiting range	13 mm ... 150 mm, 250 mm ¹⁾
Target	Natural objects
Resolution	≥ 0.1 mm
Repeatability	± 0.15 % ²⁾
Accuracy	± 1 % ³⁾
Temperature compensation	✓

¹⁾ Teach-in from 21 mm.

²⁾ In relation to the current measured value, minimum value \geq resolution.

³⁾ Referring to current measurement value.

⁴⁾ Functions may vary depending on sensor type.

Response time	24 ms
Switching frequency	30 Hz
Output time	8 ms
Ultrasonic frequency (typical)	380 kHz
Detection area (typical)	See diagrams
Additional function	Adjustable operating modes: Switching point (Dt0) / Switching window/Background (ObSB), teach-in of digital output, invertable digital output, teach-in button(s) (can be deactivated), re-set to factory default 4)

1) Teach-in from 21 mm.

2) In relation to the current measured value, minimum value \geq resolution.

3) Referring to current measurement value.

4) Functions may vary depending on sensor type.

Interfaces

Digital output	Number	1 ¹⁾
	Type	PNP
	Maximum output current I_A	≤ 200 mA
Hysteresis		2 mm

1) PNP: HIGH = $V_S - (< 2$ V) / LOW = 0 V.

Ambient data

Ambient temperature, operation	-25 °C ... +70 °C ¹⁾
Ambient temperature, storage	-40 °C ... +85 °C

1) At operating temperatures of > 50 °C, the rear side of the UC4 must be installed with its surface flat against a bracket.

Classifications

ECl@ss 5.0	27270804
ECl@ss 5.1.4	27270804
ECl@ss 6.0	27270804
ECl@ss 6.2	27270804
ECl@ss 7.0	27270804
ECl@ss 8.0	27270804
ECl@ss 8.1	27270804
ECl@ss 9.0	27270804
ECl@ss 10.0	27270804
ECl@ss 11.0	27270804
ETIM 5.0	EC001846
ETIM 6.0	EC001846
ETIM 7.0	EC001846
UNSPSC 16.0901	41111960

Dimensional drawing (Dimensions in mm (inch))

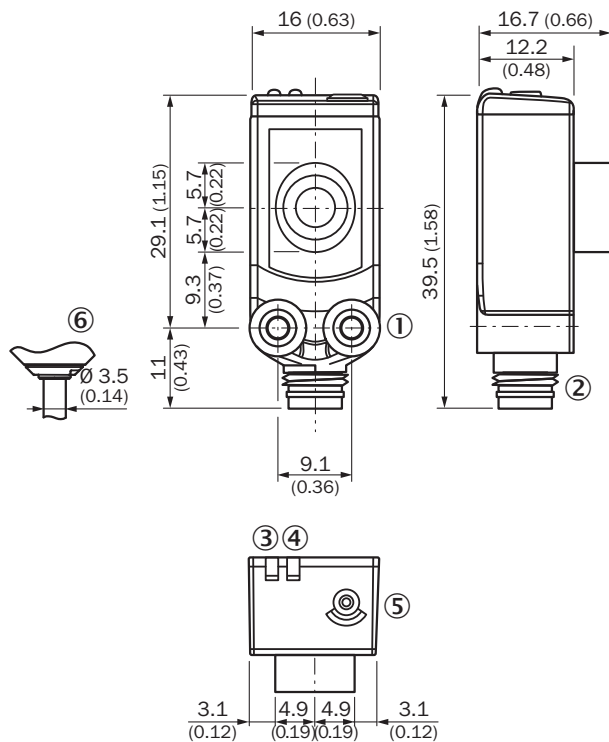

- ① Threaded mounting hole M3
- ② Connection
- ③ Status indicator digital output (orange)
- ④ Status display for supply voltage active (green)
- ⑤ Control elements

Connection type

Connector M8, 3-pin

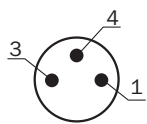

Connection diagram

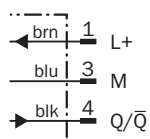

Adjustment possible

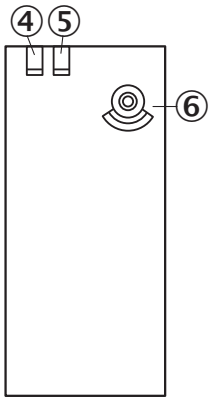

- ④ Status indicator digital output (orange)
- ⑤ Status display for supply voltage active (green)
- ⑥ Control elements

Detection area

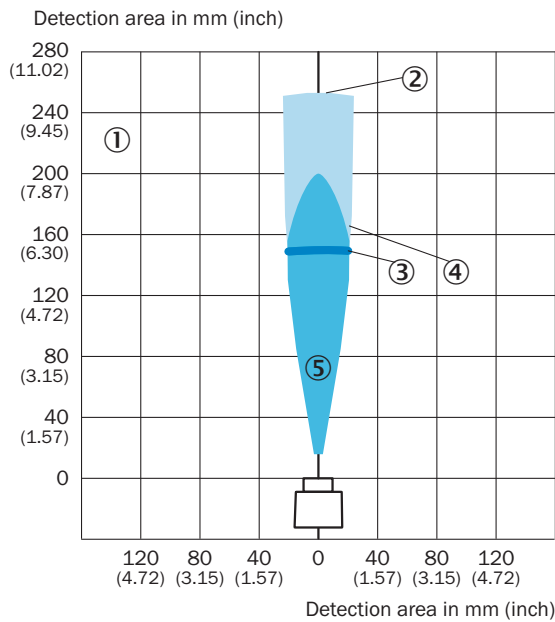

UC4-13



- ① Detection range dependent on reflection properties, size, and alignment of the object
- ② Limiting range
- ③ Operating range
- ④ Example object: aligned plate 100 mm x 100 mm
- ⑤ Example object: cylindrical bar with a diameter of 10 mm

Recommended accessories

Other models and accessories → www.sick.com/UC4

	Brief description	Type	Part no.
Mounting brackets and plates			
	Mounting bracket for wall mounting, Stainless steel 1.4571, mounting hardware included	BEF-W4-A	2051628
Hardware			
	Accessory for ultrasonic channeling for the product family UC4	SonicTube UC4	5329249
Plug connectors and cables			
	Head A: female connector, M8, 3-pin, straight, A-coded Head B: Flying leads Cable: Sensor/actuator cable, PVC, unshielded, 2 m	YF8U13-020VA1XLEAX	2095860

Recommended services

Additional services → www.sick.com/UC4

	Type	Part no.
Warranty extensions		
<ul style="list-style-type: none"> • Product area: Identification solutions, machine vision, Distance sensors, Detection and ranging solutions • Range of services: The services correspond to the scope of the statutory manufacturer warranty (SICK general terms and conditions of purchase) • Duration: Five-year warranty from delivery date. 	Extended warranty for a total of five years from delivery date	1680671

SICK AT A GLANCE

SICK is one of the leading manufacturers of intelligent sensors and sensor solutions for industrial applications. A unique range of products and services creates the perfect basis for controlling processes securely and efficiently, protecting individuals from accidents and preventing damage to the environment.

We have extensive experience in a wide range of industries and understand their processes and requirements. With intelligent sensors, we can deliver exactly what our customers need. In application centers in Europe, Asia and North America, system solutions are tested and optimized in accordance with customer specifications. All this makes us a reliable supplier and development partner.

Comprehensive services complete our offering: SICK LifeTime Services provide support throughout the machine life cycle and ensure safety and productivity.

For us, that is “Sensor Intelligence.”

WORLDWIDE PRESENCE:

Contacts and other locations –www.sick.com