

# Digital Modules ASi, IP67, M12



2 x 2 connectors for profile cable

2 color LEDs per output, state (yellow), overload (red) (optional)



(Figure similar)



| Figure | Type          | Inputs digital | Outputs digital                            | M12 connection (1)             | Input voltage (sensor supply) (2) | Output voltage (actuator supply) (3) | ASi connection (4) | ASi address (5)      | Max. output current | Art. no. |
|--------|---------------|----------------|--|--------------------------------|-----------------------------------|--------------------------------------|--------------------|----------------------|---------------------|----------|
|        | IP67, 4 x M12 | 2              | 2 x electronic                             | Y                              | out of ASi                        | out of AUX                           | ASi profile cable  | 1 AB slave           | 1 A per output      | BWU3456  |
|        | IP67, 4 x M12 | 2              | 2 x electronic, special ASi bit assignment | Y                              | out of ASi                        | out of AUX                           | ASi profile cable  | 1 AB slave           | 1 A per output      | BWU3539  |
|        | IP67, 4 x M12 | 2              | 2 x electronic, special ASi bit assignment | Y                              | out of ASi                        | out of AUX                           | ASi profile cable  | 1 single slave       | 1 A per output      | BWU3775  |
|        | IP67, 4 x M12 | 2              | 2 x electronic                             | single                         | out of ASi                        | out of AUX                           | ASi profile cable  | 1 AB slave           | 1 A per output      | BWU3141  |
|        | IP67, 4 x M12 | 2              | 2 x electronic                             | single                         | out of ASi                        | out of AUX                           | ASi via M12        | 1 AB slave           | 1 A per output      | BWU3517  |
|        | IP67, 4 x M12 | 4              | –  | Y                              | out of ASi                        | –                                    | ASi profile cable  | 1 AB slave           | –                   | BWU2552  |
|        | IP67, 4 x M12 | 4              | –  | Y                              | out of ASi                        | –                                    | ASi via M12        | 1 AB slave           | –                   | BWU3077  |
|        | IP67, 4 x M12 | 4              | –  | single                         | out of ASi                        | –                                    | ASi profile cable  | 1 AB slave           | –                   | BWU2620  |
|        | IP67, 4 x M12 | 4              | –  | single                         | out of ASi                        | –                                    | ASi profile cable  | 1 AB slave S-0.A.7.0 | –                   | BWU3556  |
|        | IP67, 4 x M12 | 4              | –  | single                         | out of ASi                        | –                                    | ASi via M12        | 1 AB slave           | –                   | BWU3457  |
|        | IP67, 4 x M12 | 4              | –  | single                         | out of AUX                        | –                                    | ASi profile cable  | 1 AB slave           | –                   | BWU2725  |
|        | IP67, 4 x M12 | 4              | 2 x electronic                             | mixed                          | out of AUX                        | out of AUX                           | ASi profile cable  | 1 AB slave           | 1 A per output      | BWU2767  |
|        | IP67, 4 x M12 | 4              | 4 x electronic                             | mixed                          | out of ASi                        | out of ASi                           | ASi profile cable  | 1 AB slave           | 120 mA per output   | BWU3240  |
|        | IP67, 4 x M12 | 4              | 4 x electronic                             | mixed                          | out of AUX                        | out of AUX                           | ASi profile cable  | 1 AB slave           | 500 mA per output   | BWU2547  |
|        | IP67, 4 x M12 | 4              | 4 x electronic                             | mixed (inputs/outputs swapped) | out of AUX                        | out of AUX                           | ASi profile cable  | 1 AB slave           | 500 mA per output   | BWU3887  |
|        | IP67, 4 x M12 | 4              | 4 x electronic                             | Y                              | out of ASi                        | out of AUX                           | ASi profile cable  | 1 AB slave           | 500 mA per output   | BWU2487  |
|        | IP67, 4 x M12 | 4              | 4 x electronic                             | Y                              | out of AUX                        | out of AUX                           | ASi profile cable  | 1 AB slave           | 500 mA per output   | BWU3032  |
|        | IP67, 4 x M12 | 4              | 3 x electronic                             | Y                              | out of ASi                        | out of AUX                           | ASi profile cable  | 1 AB slave           | 500 mA per output   | BWU3375  |
|        | IP67, 4 x M12 | –              | 4 x electronic                             | Y                              | –                                 | out of AUX                           | ASi profile cable  | 1 single slave       | 1 A per output      | BWU2713  |
|        | IP67, 4 x M12 | –              | 4 x electronic                             | Y                              | –                                 | out of AUX                           | ASi profile cable  | 1 AB slave           | 1 A per output      | BWU2594  |
|        | IP67, 4 x M12 | –              | 4 x electronic                             | Y                              | –                                 | out of AUX, 2A per output            | ASi profile cable  | 1 AB slave           | 2 A per output      | BWU2728  |

# Digital Modules ASi, IP67, M12



| Figure | Type          | Inputs digital | Outputs digital | M12 connection <sup>(1)</sup> | Input voltage (sensor supply) <sup>(2)</sup> | Output voltage (actuator supply) <sup>(3)</sup> | ASi connection <sup>(4)</sup> | ASi address <sup>(5)</sup> | Max. output current | Art. no. |
|--------|---------------|----------------|-----------------|-------------------------------|--|---|-------------------------------|----------------------------|---------------------|----------|
|        | IP67, 8 x M12 | 4              | 4 x electronic  | Y                             | out of ASi                                   | out of AUX                                      | ASi profile cable             | 1 AB slave                 | 1 A per output      | BWU2626  |
|        | IP67, 8 x M12 | 4              | 4 x electronic  | Y                             | out of ASi                                   | out of AUX                                      | ASi profile cable             | 1 AB slave                 | 2 A per output      | BWU3426  |
|        | IP67, 8 x M12 | 4              | 4 x electronic  | single                        | out of ASi                                   | out of AUX                                      | ASi profile cable             | 1 AB slave                 | 1 A per output      | BWU2617  |
|        | IP67, 8 x M12 | 4              | 4 x electronic  | single                        | out of ASi                                   | out of AUX                                      | ASi profile cable             | 1 single slave             | 1 A per output      | BWU2684  |
|        | IP67, 8 x M12 | 4              | 4 x electronic  | single                        | out of AUX                                   | out of AUX                                      | ASi profile cable             | 1 AB slave                 | 1 A per output      | BWU2810  |
|        | IP67, 8 x M12 | 4              | 4 x electronic  | Y                             | out of AUX                                   | out of AUX                                      | ASi profile cable             | 1 AB slave                 | 1 A per output      | BWU3510  |
|        | IP67, 8 x M12 | 4              | 4 x electronic  | single                        | out of AUX                                   | out of AUX                                      | ASi using M12                 | 1 AB slave                 | 1 A per output      | BWU2645  |
|        | IP67, 8 x M12 | 4              | 4 x electronic  | single                        | out of ASi                                   | out of AUX, 2A per output                       | ASi profile cable             | 1 single slave             | 2 A per output      | BWU3540  |
|        | IP67, 8 x M12 | 4              | 3 x electronic  | single                        | out of ASi                                   | out of AUX, 2A per output                       | ASi profile cable             | 1 AB slave                 | 2 A per output      | BWU3496  |
|        | IP67, 8 x M12 | 8              | –               | Y                             | out of AUX                                   | –   | ASi profile cable             | 2 AB slaves                | –                   | BWU2770  |
|        | IP67, 8 x M12 | 8              | –               | Y                             | out of ASi                                   | –   | ASi profile cable             | 2 AB slaves                | –                   | BWU2651  |
|        | IP67, 8 x M12 | 8              | –               | single                        | out of ASi                                   | –   | ASi profile cable             | 2 AB slaves                | –                   | BWU2983  |
|        | IP67, 8 x M12 | 8              | 8 x electronic  | Y                             | out of ASi                                   | out of AUX                                      | ASi profile cable             | 2 AB slaves                | 1 A per output      | BWU2619  |
|        | IP67, 8 x M12 | 8              | 8 x electronic  | Y                             | out of AUX                                   | out of AUX                                      | ASi profile cable             | 2 AB slaves                | 1 A per output      | BWU3892  |
|        | IP67, 8 x M12 | –              | 8 x electronic  | Y                             | –  | out of AUX                                      | ASi profile cable             | 2 AB slaves                | 1 A per output      | BWU2652  |

Replacement, ASi Version 2: single slaves (digital) are also working with the first generation ASi masters.

(1) **M12 wiring:** either as a single-wiring, Y-wiring or mixed-wiring.

**Single-wiring**

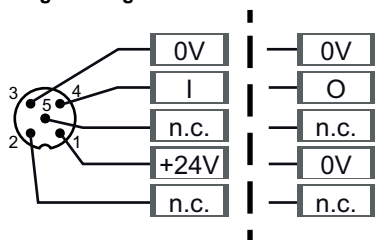

**Y-wiring**

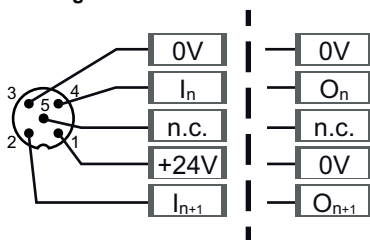

**Mixed-wiring**

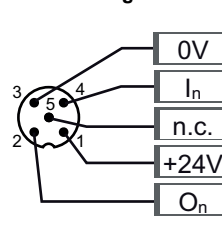

(2) **Input voltage (sensor supply):** inputs are supplied by ASi or by AUX (auxiliary 24 V power). If supplied by ASi, inputs shall not be connected to earth or to external potential.

(3) **Output voltage (actuator supply):** outputs are supplied by ASi or by AUX (auxiliary 24 V power). If supplied by ASi, outputs shall not be connected to earth or to external potential

(4) **ASi connection:** the connection to ASi as well to AUX (auxiliary 24 V power) is made via yellow resp. black ASi profile cable with piercing technology or via M12 socket (in IP20 via clamps).

(5) **ASi address:** 1 AB Slave (max. 62 AB Slaves/ASi network), 2 AB Slaves (max. 31 modules with 2 AB Slaves), Single Slaves (max. 31 Single Slaves/ASi network), mixed use allowed.

For modules with two slaves the second slave is turned off as long as the first slave is addressed to address "0". Upon request, slaves are available with specific ASi Slave profiles.

# Digital Modules ASi, IP67, M12



| Article No.  | BWU3077   | BWU2552                    | BWU2620                 | BWU3556                 | BWU3457  | BWU2725                    |  |
|--|---|----------------------------|-------------------------|-------------------------|--|----------------------------|--|
| <b>General data</b>                                      |   |                            |                         |                         |  |                            |  |
| Device type  | input   |                            |                         |                         |  |                            |  |
| <b>Connection</b>  |   |                            |                         |                         |  |                            |  |
| ASi/AUX connection                                       | M12 <sup>(1)</sup>  | profile cable and piercing |                         |                         | M12 <sup>(1)</sup>   | profile cable and piercing |  |
| Periphery connection                                     | M12, Y-wiring   |                            | M12, single-wiring      |                         |  |                            |  |
| Length of connector cable                                | unlimited <sup>(2)</sup>  |                            |                         |                         |  |                            |  |
| <b>ASi</b>   |   |                            |                         |                         |  |                            |  |
| Profile  | S-0.A.E (ID1=7 default)   |                            | S-0.A.0 (ID1=7 default) | S-0.A.E (ID1=7 default) | S-0.A.E (ID1=7 default)                                      |                            |  |
| Address  | 1 AB slave  |                            |                         |                         |  |                            |  |
| Required Master profile                                  | ≥M3   |                            |                         |                         |  |                            |  |
| As of ASi specification                                  | 2.1   |                            |                         |                         |  |                            |  |
| Operating voltage  | 30 V (18 ... 31.6 V)  |                            |                         |                         |  |                            |  |
| Max. current consumption                                 | 165 mA  |                            |                         |                         | 45 mA  |                            |  |
| Max. current consumption without sensor/ actuator supply | 45 mA   |                            |                         |                         |  |                            |  |
| <b>AUX</b>   |   |                            |                         |                         |  |                            |  |
| Operating voltage  | -   |                            |                         |                         | 24 V (18 ... 30 V)   |                            |  |
| Max. current consumption                                 | -   |                            |                         |                         | 1 A  |                            |  |
| <b>Input</b>   |   |                            |                         |                         |  |                            |  |
| Number   | 4   |                            |                         |                         |  |                            |  |
| Power supply   | out of ASi  |                            |                         |                         | out of AUX   |                            |  |
| Sensor supply  | short-circuit and overload protected according to EN 61131-2  |                            |                         |                         |  |                            |  |
| Power supply of attached sensors                         | up to +40 °C  | 120 mA <sup>(3)</sup>      |                         |                         |  | max. 1 A                   |  |
|  | at +55 °C   | 100 mA <sup>(3)</sup>      |                         |                         |  |                            |  |
|  | at +70 °C   | 80 mA <sup>(3)</sup>       |                         |                         |  |                            |  |
| Switching threshold                                      | U<5 V (low)<br>U>15 V (high)  |                            |                         |                         |  |                            |  |
| <b>Display</b>   |   |                            |                         |                         |  |                            |  |
| LED ASi (green)  | on: ASi voltage on<br>flashing: ASi voltage on, but peripheral fault <sup>(4)</sup> or address 0<br>off: no ASi voltage |                            |                         |                         |  |                            |  |
| LED FLT/FAULT (red)                                      | on: slave address 0 or slave offline<br>flashing: peripheral fault <sup>(4)</sup><br>off: slave online                  |                            |                         |                         |  |                            |  |
| LED AUX (green)  | -   |                            |                         |                         | on: 24 V <sub>DC</sub> AUX<br>off: no 24 V <sub>DC</sub> AUX |                            |  |
| LEDs I1 ... In (yellow)                                  | state of inputs<br>I1 ... I4  |                            |                         |                         |  |                            |  |

# Digital Modules ASi, IP67, M12



| Article No.  | BWU3077  | BWU2552   | BWU2620 | BWU3556 | BWU3457                     | BWU2725   |
|--|--|---|---------|---------|-----------------------------|---|
| <b>Environment</b>                                 |  |   |         |         |                             |   |
| Applied standards                                  | EN 61000-6-2<br>EN 61000-6-3<br>EN 61131-2<br>EN 60529           |   |         |         |                             |   |
| Can be used in passively safe paths up to SIL3/PLe | yes <sup>(5)</sup>   |   |         |         |                             | yes <sup>(9)</sup>  |
| Operating altitude                                 | max. 2000 m  |   |         |         |                             |   |
| Ambient temperature                                | -30 °C ... +55 °C<br>(up to max. +70 °C) <sup>(3) (6)</sup>      |   |         |         |                             |   |
| Storage temperature                                | -25 °C ... +85 °C  |   |         |         |                             |   |
| Housing  | plastic, for screw mounting                                      | plastic, for DIN rail mounting or for screw mounting <sup>(8)</sup> |         |         | plastic, for screw mounting | plastic, for DIN rail mounting or for screw mounting <sup>(8)</sup> |
| Pollution degree                                   | 2  |   |         |         |                             |   |
| Protection category                                | IP67 <sup>(7)</sup>  |   |         |         |                             |   |
| Tolerable loading referring to humidity            | according to EN 61131-2  |   |         |         |                             |   |
| Max. tolerable shock load                          | 30g, 11 ms, acc. EN 61131-2                                      |   |         |         |                             |   |
| Max. tolerable vibration stress                    | 5 ... 8 Hz 50 mm <sub>pp</sub> /8 ... 500 Hz 6g, acc. EN 61131-2 |   |         |         |                             |   |
| Insulation voltage                                 | ≥500 V   |   |         |         |                             |   |
| Weight   | 100 g  |   |         |         |                             |   |
| Dimensions (W / H / D) in mm                       | 45 / 116,5 / 47,5  | 45 / 80 / 42  |         |         | 45 / 116,5 / 47,5           | 45 / 80 / 42  |

**(1) Line protection:**

If the module is supplied via a M12 connection with A or B coding, it may only be used with a current load of max. 4 A per pin in acc. with IEC 61076-2-101 and IEC 61076-2-109. A fused tap is recommended. There is no such limitation for modules supplied via piercing contacts.

**Connection to ASi and AUX via M12**

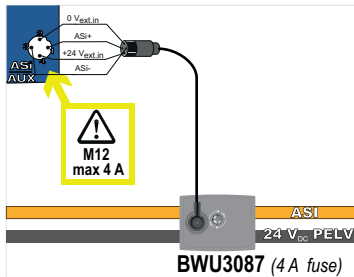

**via piercing contacts**

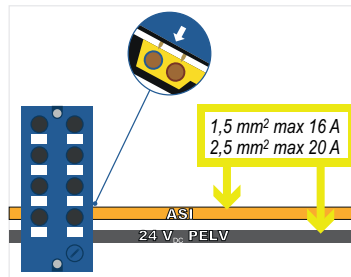

(2) Loop resistance ≤150 Ω

**(3) BWU2552, BWU2620, BWU3077, BWU3457, BWU3556 Derating power supply of attached sensors**

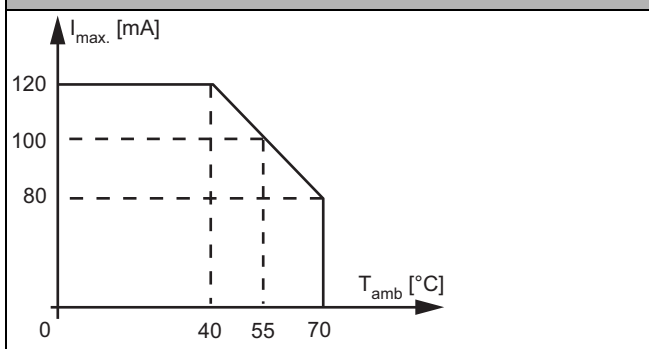

(4) See table "Peripheral fault indication"

(5) The module is suitable for use in passively safe paths as it has no connection to an AUX potential.

# Digital Modules ASi, IP67, M12



- (6) Maximum ambient operating temperature +55 °C according UL certificate for the use in the USA and Canada
- (7) Protection category IP67 can only be achieved if all open connections are sealed with suitable end caps fulfilling the same protection category.
- (8) Depending on substructure module (see accessories). The substructure module is not included in the scope of delivery.
- (9) BWU2725 from Ident. No. 18225; the module is suitable for use in passively safe paths because an exclusion of errors can be assumed for the connection of the two potentials, ASi and AUX.

| Article No.  | BWU2770   |          | BWU2651               | BWU2983 |
|--|---|----------|-----------------------|---------|
| <b>General data</b>                                      |   |          |                       |         |
| Device type  | input   |          |                       |         |
| <b>Connection</b>  |   |          |                       |         |
| ASi/AUX connection                                       | profile cable and piercing  |          |                       |         |
| Periphery connection                                     | M12, Y-wiring   |          | M12, single-wiring    |         |
| Length of connector cable                                | unlimited <sup>(1)</sup>  |          |                       |         |
| <b>ASi</b>   |   |          |                       |         |
| Profile  | slave 1: S-0.A.E (ID1=7 default),<br>slave 2: S-0.A.E (ID1=6 default)   |          |                       |         |
| Address  | 2 AB slaves   |          |                       |         |
| Required Master profile                                  | ≥M3   |          |                       |         |
| As of ASi specification                                  | 2.1   |          |                       |         |
| Operating voltage  | 30 V (18 ... 31.6 V)  |          |                       |         |
| Max. current consumption                                 | 60 mA   | 270 mA   |                       |         |
| Max. current consumption without sensor/ actuator supply | 60 mA   | 70 mA    |                       |         |
| <b>AUX</b>   |   |          |                       |         |
| Operating voltage  | 24 V (18 ... 30 V)  | –        |                       |         |
| Max. current consumption                                 | 3 A   | –        |                       |         |
| <b>Input</b>   |   |          |                       |         |
| Number   | 4   |          |                       |         |
| Power supply   | out of AUX  |          | out of ASi            |         |
| Sensor supply  | short-circuit and overload protected according to EN 61131-2  |          |                       |         |
| Power supply of attached sensors                         | up to +40 °C  | max. 1 A | 200 mA <sup>(6)</sup> |         |
|  | at +55 °C   |          | 150 mA <sup>(3)</sup> |         |
|  | at +70 °C   |          | 100 mA <sup>(3)</sup> |         |
| Switching threshold                                      | U < 5 V (low)<br>U > 15 V (high)  |          |                       |         |
| <b>Display</b>   |   |          |                       |         |
| LED ASI/FLT 1 (red/green)                                | green: slave online<br>red: slave offline<br>yellow/red flashing: address 0<br>red/green flashing: peripheral fault <sup>(2)</sup>  |          |                       |         |
| LED ASI/FLT 2 (red/green)                                | green: slave online<br>red: slave offline<br>yellow/red flashing: address 0<br>red/green flashing: peripheral fault <sup>(4)</sup><br>red flashing: slave 2 is switched off, because slave 1 is offline |          |                       |         |
| LED AUX (green)  | on: 24 V <sub>DC</sub> AUX<br>off: no 24 V <sub>DC</sub> AUX  |          | –                     |         |
| LEDs I1 ... I8 (yellow)                                  | state of inputs I1 ... I8   |          |                       |         |

# Digital Modules ASi, IP67, M12

| Article No.  | BWU2770  | BWU2651            | BWU2983 |
|--|--|--------------------|---------|
| <b>Environment</b>                                 |  |                    |         |
| Applied standards                                  | EN 61000-6-2<br>EN 61000-6-3<br>EN 61131-2<br>EN 60529           |                    |         |
| Can be used in passively safe paths up to SIL3/PLe | no <sup>(3)</sup>  | yes <sup>(7)</sup> |         |
| Operating altitude                                 | max. 2000 m  |                    |         |
| Ambient temperature                                | -30 °C ... +55 °C<br>(up to max. +70 °C) <sup>(4) (6)</sup>      |                    |         |
| Storage temperature                                | -25 °C ... +85 °C  |                    |         |
| Housing  | plastic, for screw mounting                                      |                    |         |
| Pollution degree                                   | 2  |                    |         |
| Protection category                                | IP67 <sup>(5)</sup>  |                    |         |
| Tolerable loading referring to humidity            | according to EN 61131-2  |                    |         |
| Max. tolerable shock load                          | 30g, 11 ms, acc. EN 61131-2                                      |                    |         |
| Max. tolerable vibration stress                    | 5 ... 8 Hz 50 mm <sub>pp</sub> /8 ... 500 Hz 6g, acc. EN 61131-2 |                    |         |
| Insulation voltage                                 | ≥500 V   |                    |         |
| Weight   | 200 g  |                    |         |
| Dimensions (W / H / D) in mm                       | 60 / 151 / 31  |                    |         |

(1) Loop resistance ≤150 Ω

(2) **See table "Peripheral fault indication"**

(3) The module is not suitable for use in passively safe paths because an exclusion of errors cannot be assumed for the connection of the two potentials, ASi and AUX.

(4) Maximum ambient operating temperature +55 °C according UL certificate for the use in the USA and Canada

(5) Protection category IP67 can only be achieved if all open connections are sealed with suitable end caps fulfilling the same protection category.

(6)

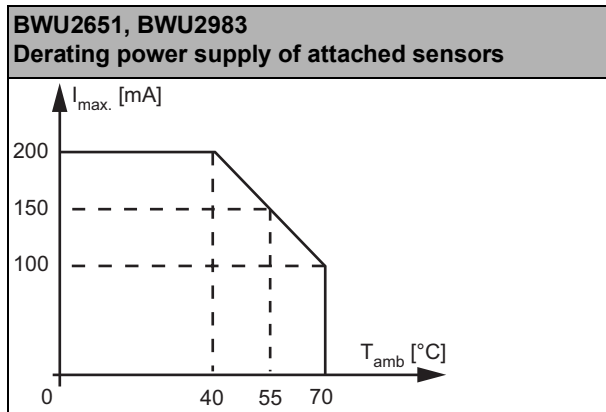

(7) The module is suitable for use in passively safe paths as it has no connection to an AUX potential.

# Digital Modules ASi, IP67, M12



| Article No.  | BWU3775   | BWU3539   | BWU3456 | BWU3141            |
|--|---|---|---------|--------------------|
| <b>General data</b>                                      |   |   |         |                    |
| Device type  | input / output  |   |         |                    |
| <b>Connection</b>  |   |   |         |                    |
| ASi/AUX Connection                                       | profile cable and piercing  |   |         |                    |
| Periphery connection                                     | M12, Y-wiring   |   |         | M12, single-wiring |
| Length of connector cable                                | unlimited <sup>(1)</sup>  |   |         |                    |
| <b>ASi</b>   |   |   |         |                    |
| Profile  | S-7.0.E (ID1=F default)   | S-7.A.7 (ID1=7 fixed)   |         |                    |
| Address  | 1 single slave  | 1 AB slave  |         |                    |
| Required Master profile                                  | ≥M0   | ≥M4   |         |                    |
| As of ASi specification                                  | 2.0   | 3.0   |         |                    |
| Operating voltage  | 30 V (18 ... 31.6 V)  |   |         |                    |
| Max. current consumption                                 | 165 mA  |   |         |                    |
| Max. current consumption without sensor/ actuator supply | 45 mA   |   |         |                    |
| <b>AUX</b>   |   |   |         |                    |
| Operating voltage  | 24 V (18 ... 30 V)  |   |         |                    |
| Max. current consumption                                 | 2 A   |   |         |                    |
| <b>Input</b>   |   |   |         |                    |
| Number   | 2   |   |         |                    |
| Power supply   | out of ASi  |   |         |                    |
| Sensor supply  | short-circuit and overload protected according to EN 61131-2  |   |         |                    |
| Power supply of attached sensors                         | up to +40 °C  | 120 mA <sup>(2)</sup>   |         |                    |
|  | at +55 °C   | 90 mA <sup>(2)</sup>  |         |                    |
|  | at +70 °C   | 60 mA <sup>(2)</sup>  |         |                    |
| Switching threshold                                      | U<5 V (low)<br>U>15 V (high)  |   |         |                    |
| <b>Output</b>  |   |   |         |                    |
| Number   | 2   |   |         |                    |
| Power supply   | out of AUX  |   |         |                    |
| Output   | short-circuit and overload protected according to EN 61131-2  |   |         |                    |
| Max. output current                                      | up to +40 °C  | 1 A per output, $\sum(\text{Out}) 2 \text{ A}$ <sup>(3)</sup>   |         |                    |
|  | at +55 °C   | 1 A per output, $\sum(\text{Out}) 1,5 \text{ A}$ <sup>(3)</sup> |         |                    |
|  | at +70 °C   | 1 A per output, $\sum(\text{Out}) 1 \text{ A}$ <sup>(3)</sup>   |         |                    |
| <b>Display</b>   |   |   |         |                    |
| LED ASi (green)  | on: ASi voltage on<br>flashing: ASi voltage on, but peripheral fault <sup>(4)</sup> or address 0<br>off: no ASi voltage |   |         |                    |
| LED FLT/FAULT (red)                                      | on: slave address 0 or slave offline<br>flashing: peripheral fault <sup>(4)</sup><br>off: slave online                  |   |         |                    |
| LED AUX (green)  | on: 24 V <sub>DC</sub> AUX<br>off: no 24 V <sub>DC</sub> AUX  |   |         |                    |
| LEDs I1, I2 (yellow)                                     | state of inputs I1, I2  |   |         |                    |
| LEDs O1 / O2 ... (yellow /red)                           | –   | yellow: state of outputs O1, O2<br>red: overload                |         |                    |
| LEDs O3 / O4 ... (yellow /red)                           | yellow: state of outputs O3, O4<br>red: overload  | –   |         |                    |

# Digital Modules ASi, IP67, M12



| Article No.  | BWU3775  | BWU3539 | BWU3456            | BWU3141 |
|--|--|---------|--------------------|---------|
| <b>Environment</b>                                 |  |         |                    |         |
| Applied standards                                  | EN 61000-6-2<br>EN 61000-6-3<br>EN 61131-2<br>EN 60529                 |         |                    |         |
| Can be used in passively safe paths up to SIL3/PLe | no <sup>(5)</sup>  |         | yes <sup>(9)</sup> |         |
| Operating altitude                                 | max. 2000 m  |         |                    |         |
| Ambient temperature                                | -30 °C ... +55 °C <sup>(2)(3)(6)</sup><br>(up to max. +70 °C)          |         |                    |         |
| Storage temperature                                | -25 °C ... +85 °C  |         |                    |         |
| Housing  | plastic, for DIN rail mounting or<br>for screw mounting <sup>(7)</sup> |         |                    |         |
| Pollution degree                                   | 2  |         |                    |         |
| Protection category                                | IP67 <sup>(8)</sup>  |         |                    |         |
| Tolerable loading referring to humidity            | according to EN 61131-2  |         |                    |         |
| Max. tolerable shock load                          | 30g, 11 ms, acc. EN 61131-2  |         |                    |         |
| Max. tolerable vibration stress                    | 5 ... 8 Hz 50 mm <sub>pp</sub> /8 ... 500 Hz 6g, acc. EN 61131-2       |         |                    |         |
| Insulation voltage                                 | ≥500 V   |         |                    |         |
| Weight   | 100 g  |         |                    |         |
| Dimensions (W / H / D) in mm                       | 45 / 80 / 42   |         |                    |         |

(1) Loop resistance ≤150 Ω

(2)

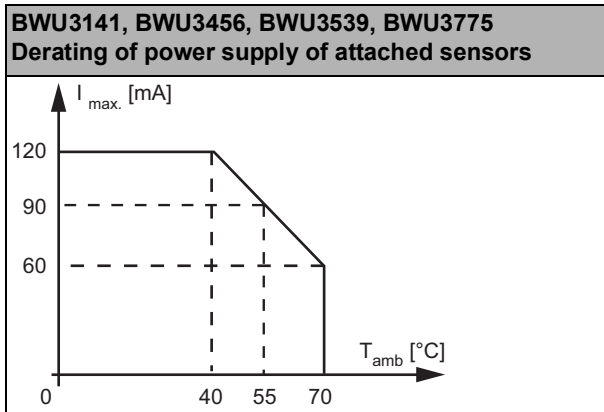

(3)

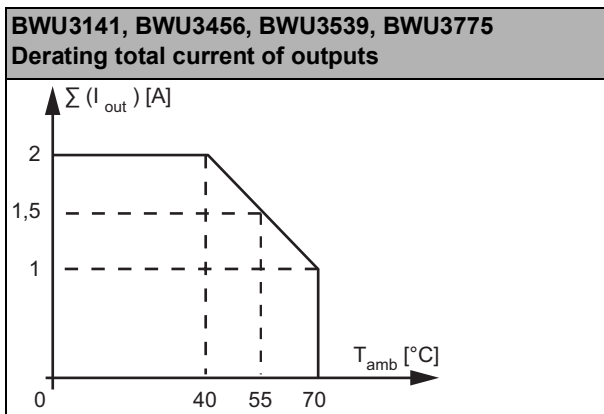

(4) See table "Peripheral fault indication"

(5) The module is not suitable for use in passively safe paths because an exclusion of errors cannot be assumed for the connection of the two potentials, ASi and AUX.

(6) Maximum ambient operating temperature +55 °C according UL certificate for the use in the USA and Canada

(7) Depending on substructure module (see accessories). The substructure module is not included in the scope of delivery.

# Digital Modules ASi, IP67, M12



- (8) Protection category IP67 can only be achieved if all open connections are sealed with suitable end caps fulfilling the same protection category.
- (9) BWU3456 from Ident.No. 18209; BWU3141 from Ident. No. 18180; the module is suitable for use in passively safe paths because an exclusion of errors can be assumed for the connection of the two potentials, ASi and AUX.

| Article No.  | BWU2767   |                              | BWU2547 |  | BWU3887 |                    | BWU3240                                |  |
|--|---|------------------------------|---------|--|---------|--------------------|--|--|
| <b>General data</b>                                      |   |                              |         |  |         |                    |  |  |
| Device type  | input / output  |                              |         |  |         |                    |  |  |
| <b>Connection</b>  |   |                              |         |  |         |                    |  |  |
| ASi/AUX Connection                                       | profile cable and piercing  |                              |         |  |         |                    |  |  |
| Periphery connection                                     | M12, mixed- wiring  |                              |         | M12, mixed- wiring (in-puts/outputs swapped)     |         | M12, mixed- wiring |  |  |
| Length of connector cable                                | unlimited <sup>(1)</sup>  |                              |         |  |         |                    |  |  |
| <b>ASi</b>   |   |                              |         |  |         |                    |  |  |
| Profile  | S-7.A.E (ID1=7 default)   |                              |         | S-7.A.7 (ID1=7 fixed)                            |         |                    |  |  |
| Address  | 1 AB slave  |                              |         |  |         |                    |  |  |
| Required Master profile                                  | ≥M3   |                              |         | ≥M4  |         |                    |  |  |
| As of ASi specification                                  | 3.0   |                              |         |  |         |                    |  |  |
| Operating voltage  | 30 V (18 ... 31.6 V)  |                              |         |  |         |                    |  |  |
| Max. current consumption                                 | 35 mA   |                              |         | 165 mA   |         |                    |  |  |
| Max. current consumption without sensor/ actuator supply | 35 mA   |                              |         | 45 mA  |         |                    |  |  |
| <b>AUX</b>   |   |                              |         |  |         |                    |  |  |
| Operating voltage  | 24 V (18 ... 30 V)  |                              |         | -  |         |                    |  |  |
| Max. current consumption                                 | 3 A   |                              |         | -  |         |                    |  |  |
| <b>Input</b>   |   |                              |         |  |         |                    |  |  |
| Number   | 4   |                              |         |  |         |                    |  |  |
| Power supply   | out of AUX  |                              |         | out of ASi                                       |         |                    |  |  |
| Sensor supply  | short-circuit and overload protected according to EN 61131-2  |                              |         |  |         |                    |  |  |
| Power supply of attached sensors                         | up to +40 °C  | max. 1 A                     |         |  |         |                    | ∑ (In/Out) max. 120 mA <sup>(12)</sup> |  |
|  | at +55 °C   |                              |         |  |         |                    | ∑ (In/Out) 90 mA <sup>(12)</sup>       |  |
|  | at +70 °C   |                              |         |  |         |                    | ∑ (In/Out) 60 mA <sup>(12)</sup>       |  |
| Switching threshold                                      | U<5 V (low)<br>U>15 V (high)  |                              |         |  |         |                    |  |  |
| <b>Output</b>  |   |                              |         |  |         |                    |  |  |
| Number   | 2   |                              |         | 4  |         |                    |  |  |
| Power supply   | out of AUX  |                              |         | out of ASi                                       |         |                    |  |  |
| Output   | short-circuit and overload protected according to EN 61131-2  |                              |         |  |         |                    |  |  |
| Max. output current                                      | up to +40 °C  | 1 A per output<br>∑(Out) 2 A |         | 500 mA per output<br>∑(Out) 2 A <sup>(9)</sup>   |         |                    | ∑ (In/Out) 120 mA <sup>(12)</sup>      |  |
|  | at +55 °C   |                              |         | 500 mA per output<br>∑(Out) 1,5 A <sup>(9)</sup> |         |                    | ∑ (In/Out) 90 mA <sup>(12)</sup>       |  |
|  | at +70 °C   |                              |         | 500 mA per output<br>∑(Out) 1 A <sup>(9)</sup>   |         |                    | ∑ (In/Out) 60 mA <sup>(12)</sup>       |  |
| <b>Display</b>   |   |                              |         |  |         |                    |  |  |
| LED ASi (green)  | on: ASi voltage on<br>flashing: ASi voltage on, but peripheral fault <sup>(2)</sup> or address 0<br>off: no ASi voltage |                              |         |  |         |                    |  |  |
| LED FLT/FAULT (red)                                      | on: slave address 0 or slave offline<br>flashing: peripheral fault <sup>(2)</sup><br>off: slave online                  |                              |         |  |         |                    |  |  |
| LED AUX (green)  | on: 24 V <sub>DC</sub> AUX<br>off: no 24 V <sub>DC</sub> AUX  |                              |         | -  |         |                    |  |  |
| LEDs I1 / O1 ... In / On (yellow)                        | state of inputs/outputs I1 / O1 ... I4 / O4<br>input <b>or</b> output is on <sup>(3)</sup>                              |                              |         |  |         |                    |  |  |

# Digital Modules ASi, IP67, M12

| Article No.  | BWU2767   | BWU2547             | BWU3887             | BWU3240             |
|--|---|---------------------|---------------------|---------------------|
| <b>Environment</b>                                 |   |                     |                     |                     |
| Applied standards                                  | EN 61000-6-2<br>EN 61000-6-3<br>EN 61131-2<br>EN 60529  |                     |                     |                     |
| Can be used in passively safe paths up to SIL3/PLe | yes <sup>(4)</sup>  | yes <sup>(10)</sup> | yes <sup>(11)</sup> | yes <sup>(13)</sup> |
| Operating altitude                                 | max. 2000 m   |                     |                     |                     |
| Ambient temperature                                | -30 °C ... +55 °C <sup>(5)</sup> <sup>(6)</sup> <sup>(9)</sup> <sup>(12)</sup><br>(up to max. +70 °C) |                     |                     |                     |
| Storage temperature                                | -25 °C ... +85 °C   |                     |                     |                     |
| Housing  | plastic, for DIN rail mounting or<br>for screw mounting <sup>(7)</sup>                                |                     |                     |                     |
| Pollution degree                                   | 2   |                     |                     |                     |
| Protection category                                | IP67 <sup>(8)</sup>   |                     |                     |                     |
| Tolerable loading referring to humidity            | according to EN 61131-2   |                     |                     |                     |
| Max. tolerable shock load                          | 30g, 11 ms, acc. EN 61131-2   |                     |                     |                     |
| Max. tolerable vibration stress                    | 5 ... 8 Hz 50 mm <sub>pp</sub> /8 ... 500 Hz 6g, acc. EN 61131-2                                      |                     |                     |                     |
| Insulation voltage                                 | ≥500 V  |                     |                     |                     |
| Weight   | 100 g   |                     |                     |                     |
| Dimensions (W / H / D) in mm                       | 45 / 80 / 42  |                     |                     |                     |

(1) Loop resistance ≤150 Ω

(2) **See table "Peripheral fault indication"**

(3) **BWU2767:** LEDs I3/O3 and I4/O4 are indicating only the state of inputs I3 and I4 in accordance with the factual input/output assignment.

(4) BWU2767 from ID no. 18851; The module is suitable for use in passively safe paths because an exclusion of errors can be assumed for the connection of the two potentials, ASi and AUX.

(5) Temperature range up to -30°C from Ident.No. ≥16388 (BWU2767).

(6) Maximum ambient operating temperature +55 °C according UL certificate for the use in the USA and Canada

(7) Depending on substructure module (see accessories). The substructure module is not included in the scope of delivery.

(8) Protection category IP67 can only be achieved if all open connections are sealed with suitable end caps fulfilling the same protection category.

(9)

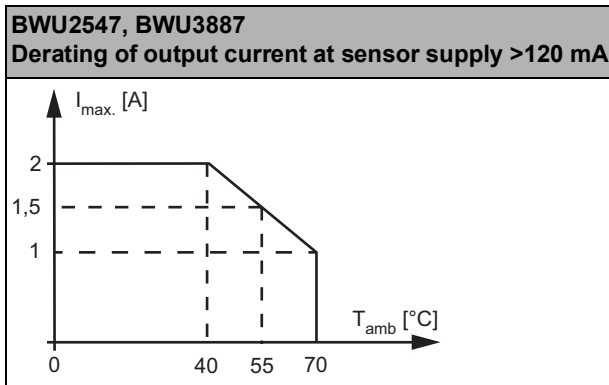

(10) BWU2547 from Ident. No. 18173; the module is suitable for use in passively safe paths because an exclusion of errors can be assumed for the connection of the two potentials, ASi and AUX.

(11) BWU3887 from Ident. No. 18303; the module is suitable for use in passively safe paths because an exclusion of errors can be assumed for the connection of the two potentials, ASi and AUX.

# Digital Modules ASi, IP67, M12

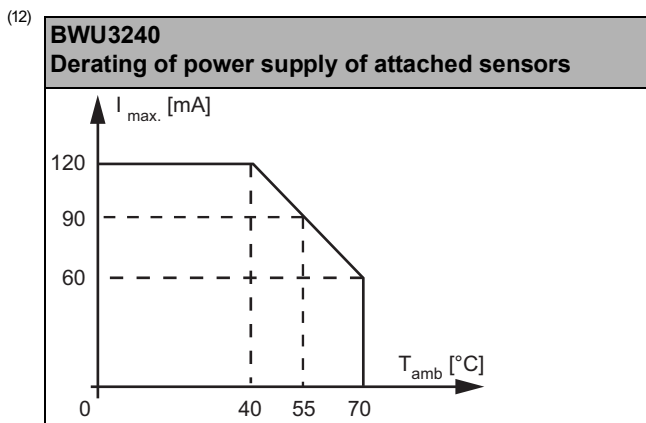

(13) The module is suitable for use in passively safe paths as it has no connection to an AUX potential.

| Article No.  | BWU2487  | BWU3032               | BWU3375                 | BWU3517               |   |
|--|--|-----------------------|-------------------------|-----------------------|---|
| <b>General data</b>                                      |  |                       |                         |                       |   |
| Device type  | input / output   |                       |                         |                       |   |
| <b>Connection</b>  |  |                       |                         |                       |   |
| ASi/AUX Connection                                       | profile cable and piercing                                   |                       |                         | M12 <sup>(9)</sup>    |   |
| Periphery connection                                     | M12, Y-wiring  |                       |                         | M12, single wiring    |   |
| Length of connector cable                                | unlimited <sup>(1)</sup>                                     |                       |                         |                       |   |
| <b>ASi</b>   |  |                       |                         |                       |   |
| Profile  | S-7.A.7 (ID1=7 fixed)  |                       | S-7.A.0 (ID1=7 default) | S-7.A.7 (ID1=7 fixed) |   |
| Address  | 1 AB slave   |                       |                         |                       |   |
| Required Master profile                                  | ≥M4  |                       | ≥M3                     | ≥M4                   |   |
| As of ASi specification                                  | 3.0  |                       | 2.1                     | 3.0                   |   |
| Operating voltage  | 30 V (18 ... 31.6 V)   |                       |                         |                       |   |
| Max. current consumption                                 | 165 mA   | 45 mA                 | 165 mA                  |                       |   |
| Max. current consumption without sensor/ actuator supply | 45 mA  |                       |                         |                       |   |
| <b>AUX</b>   |  |                       |                         |                       |   |
| Operating voltage  | 24 V (18 ... 30 V)   |                       |                         |                       |   |
| Max. current consumption                                 | 2 A  |                       |                         |                       |   |
| <b>Input</b>   |  |                       |                         |                       |   |
| Number   | 4  |                       |                         | 2                     |   |
| Power supply   | out of ASi   | out of AUX            | out of ASi              |                       |   |
| Sensor supply  | short-circuit and overload protected according to EN 61131-2 |                       |                         |                       |   |
| Power supply of attached sensors                         | up to +40 °C   | 120 mA <sup>(2)</sup> | 1 A                     | 120 mA <sup>(2)</sup> | 120 mA <sup>(10)</sup>                          |
|  | at +55 °C  | 90 mA <sup>(2)</sup>  |                         | 90 mA <sup>(2)</sup>  | 90 mA <sup>(10)</sup>                           |
|  | at +70 °C  | 60 mA <sup>(2)</sup>  |                         | 60 mA <sup>(2)</sup>  | 60 mA <sup>(10)</sup>                           |
| Switching threshold                                      | U < 5 V (low)<br>U > 15 V (high)                             |                       |                         |                       |   |
| <b>Output</b>  |  |                       |                         |                       |   |
| Number   | 4  |                       | 3                       | 2                     |   |
| Power supply   | out of AUX   |                       |                         |                       |   |
| Output   | short-circuit and overload protected according to EN 61131-2 |                       |                         |                       |   |
| Max. output current                                      | up to +40 °C   | 500 mA per output     |                         |                       | 1 A per output,<br>Σ(Out) 2 A <sup>(11)</sup>   |
|  | at +55 °C  |                       |                         |                       | 1 A per output,<br>Σ(Out) 1,5 A <sup>(11)</sup> |
|  | at +70 °C  |                       |                         |                       | 1 A per output,<br>Σ(Out) 1 A <sup>(11)</sup>   |

# Digital Modules ASi, IP67, M12

| Article No.  | BWU2487   | BWU3032  | BWU3375 | BWU3517  |
|--|---|--|---------|--|
| <b>Display</b>                                     |   |  |         |  |
| LED ASi (green)                                    | on: ASi voltage on<br>flashing: ASi voltage on, but peripheral fault <sup>(3)</sup> or address 0<br>off: no ASi voltage |  |         |  |
| LED FLT/FAULT (red)                                | on: slave address 0 or slave offline<br>flashing: peripheral fault <sup>(4)</sup><br>off: slave online                  |  |         |  |
| LED AUX (green)                                    | on: 24 V <sub>DC</sub> AUX<br>off: no 24 V <sub>DC</sub> AUX  |  |         |  |
| LEDs I1 / I2 ... In/In+1 (yellow)                  | state of inputs I1 / I2 ... I3 / I4:<br>at least 1 input of input pair is on  |  |         | state of inputs I1 / I2  |
| LEDs O1/O2 ... On / On+1 (yellow)                  | state of outputs O1 / O2 ... O3 / O4:<br>at least 1 output of output pair is on   | state of outputs O1 / O2 ... O3:<br>at least 1 output of output pair is on | -       |  |
| LEDs O1, O2 (yellow / red)                         | -   |  |         | yellow: state of outputs O1 / O2<br>red: overload              |
| <b>Environment</b>                                 |   |  |         |  |
| Applied standards                                  | EN 61000-6-2<br>EN 61000-6-3<br>EN 61131-2<br>EN 60529  |  |         |  |
| Can be used in passively safe paths up to SIL3/PLe | yes <sup>(4)</sup>  |  |         | no <sup>(12)</sup>   |
| Operating altitude                                 | max. 2000 m   |  |         |  |
| Ambient temperature                                | -30 °C ... +55 °C <sup>(2) (5) (6)</sup><br>(up to max. +70 °C)   |  |         | -30 °C ... +55 °C (up to max. +70 °C) <sup>(10) (11) (6)</sup> |
| Storage temperature                                | -25 °C ... +85 °C   |  |         |  |
| Housing  | plastic, for DIN rail mounting or for screw mounting <sup>(7)</sup>   |  |         |  |
| Pollution degree                                   | 2   |  |         |  |
| Protection category                                | IP67 <sup>(8)</sup>   |  |         |  |
| Tolerable loading referring to humidity            | according to EN 61131-2   |  |         |  |
| Max. tolerable shock load                          | 30g, 11 ms, acc. EN 61131-2   |  |         |  |
| Max. tolerable vibration stress                    | 5 ... 8 Hz 50 mm <sub>pp</sub> /8 ... 500 Hz 6g, acc. EN 61131-2  |  |         |  |
| Insulation voltage                                 | ≥500 V  |  |         |  |
| Weight   | 100 g   |  |         |  |
| Dimensions (W / H / D) in mm                       | 45 / 80 / 42  |  |         |  |

(1) Loop resistance ≤150 Ω

(2)

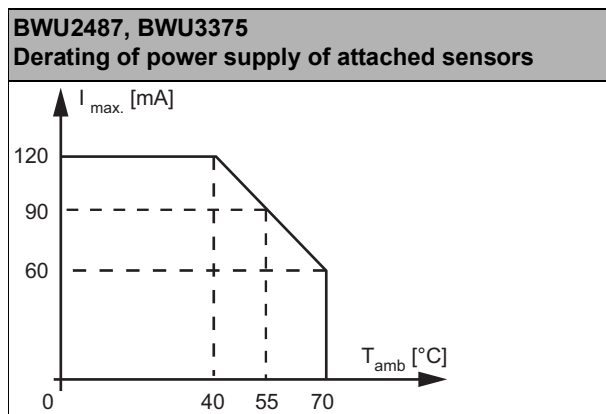

(3) See table "Peripheral fault indication"

(4) BWU2487 from Ident. No. 18369; BWU3032 from Ident. No. 18285; BWU3375 from Ident. No. 18403; the module is suitable for use in passively safe paths because an exclusion of errors can be assumed for the connection of the two potentials, ASi and AUX.

# Digital Modules ASi, IP67, M12



- (5) Temperature range up to -30°C from Ident.No. ≥16381 (BWU3032).
- (6) Maximum ambient operating temperature +55 °C according UL certificate for the use in the USA and Canada
- (7) Depending on substructure module (see accessories). The substructure module is not included in the scope of delivery.
- (8) Protection category IP67 can only be achieved if all open connections are sealed with suitable end caps fulfilling the same protection category.
- (9) **Line protection:**  
If the module is supplied via a M12 connection with A or B coding, it may only be used with a current load of max. 4 A per pin in acc. with IEC 61076-2-101 and IEC 61076-2-109. A fused tap is recommended. There is no such limitation for modules supplied via piercing contacts.

### Connection to ASi and AUX via M12

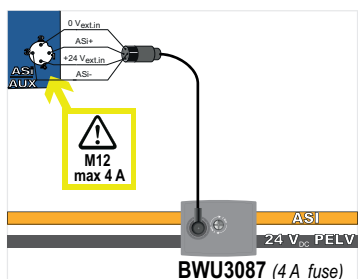

### via piercing contacts

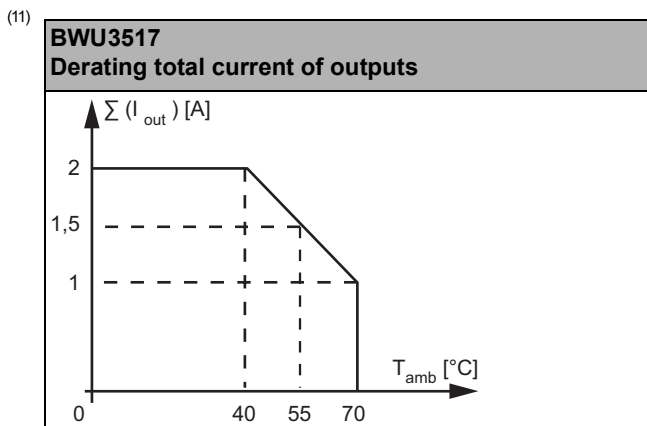
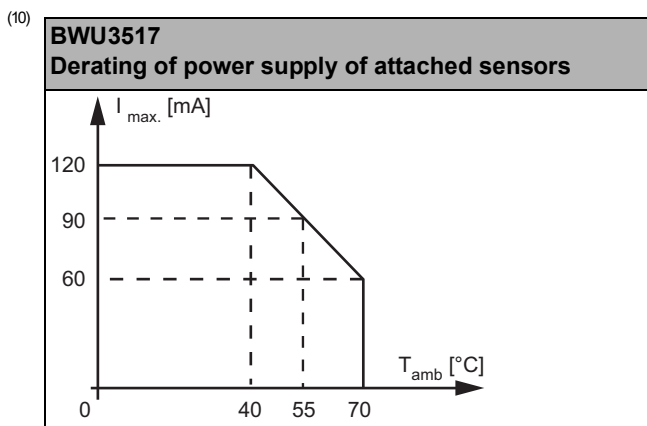
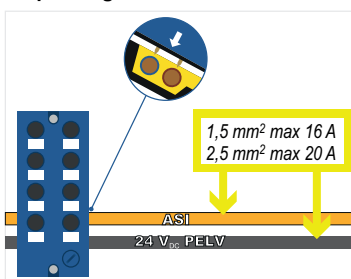

- (12) The module is not suitable for use in passively safe paths because an exclusion of errors cannot be assumed for the connection of the two potentials, ASi and AUX.

# Digital Modules ASi, IP67, M12



| Article No.  | BWU3496   | BWU3540   | BWU3426   | BWU2626 | BWU2617                                       | BWU2684                       |
|--|---|---|---|---------|---|-------------------------------|
| <b>General data</b>                                      |   |   |   |         |   |                               |
| Device type  | input / output  |   |   |         |   |                               |
| <b>Connection</b>  |   |   |   |         |   |                               |
| ASi/AUX Connection                                       | profile cable and piercing  |   |   |         |   |                               |
| Periphery connection                                     | M12,<br>single-wiring   |   | M12,<br>Y-wiring                                    |         | M12,<br>single-wiring                         |                               |
| Length of connector cable                                | unlimited <sup>(1)</sup>  |   |   |         |   |                               |
| <b>ASi</b>   |   |   |   |         |   |                               |
| Profile  | S-7.A.0<br>(ID1=7 default)  | S-7.0.E<br>(ID1=F default)                        | S-7.A.7<br>(ID1=7 fixed)                            |         | S-7.0.E<br>(ID1=F default)                    |                               |
| Address  | 1 AB slave  | 1 single slave                                    | 1 AB slave  |         | 1 single slave                                |                               |
| Required Master profile                                  | ≥M3   | ≥M0   | ≥M4   |         | ≥M0   |                               |
| As of ASi specification                                  | 2.1   | 2.0   | 3.0   |         | 2.0   |                               |
| Operating voltage  | 30 V (18 ... 31.6 V)  |   |   |         |   |                               |
| Max. current consumption                                 | 165 mA  |   |   |         |   |                               |
| Max. current consumption without sensor/ actuator supply | 45 mA   |   |   |         |   |                               |
| <b>AUX</b>   |   |   |   |         |   |                               |
| Operating voltage  | 24 V (18 ... 30 V)  |   |   |         |   |                               |
| Max. current consumption                                 | 6 A   | 8 A   |   | 3 A     |   |                               |
| <b>Input</b>   |   |   |   |         |   |                               |
| Number   | 4   |   |   |         |   |                               |
| Power supply   | out of ASi  |   |   |         |   |                               |
| Sensor supply  | short-circuit and overload protected according to EN 61131-2  |   |   |         |   |                               |
| Power supply of attached sensors                         | up to +40 °C  | 120 mA <sup>(2)</sup>                             |   |         |   |                               |
|  | at +55 °C   | 100 mA <sup>(2)</sup>                             |   |         |   |                               |
|  | at +70 °C   | 80 mA <sup>(2)</sup>                              |   |         |   |                               |
| Switching threshold                                      | U<5 V (low)<br>U>15 V (high)  |   |   |         |   |                               |
| <b>Output</b>  |   |   |   |         |   |                               |
| Number   | 3   | 4   |   |         |   |                               |
| Power supply   | out of AUX  |   |   |         |   |                               |
| Output   | short-circuit and overload protected according to EN 61131  |   |   |         |   |                               |
| Max. output current                                      | up to +40 °C  | 2 A per output,<br>Σ (Out) 6 A <sup>(3)</sup>     | 2 A per output,<br>Σ (Out) 8 A <sup>(3)</sup>       |         | 1 A per output,<br>Σ (Out) 3 A <sup>(8)</sup> |                               |
|  | at +55 °C   | 1,5 A per output,<br>Σ (Out) 4,5 A <sup>(3)</sup> | 1,5 A per output,<br>Σ (Out) 6 A <sup>(3)</sup>     |         |   |                               |
|  | at +70 °C   | 1 A per output,<br>Σ (Out) 3 A <sup>(3)</sup>     | 1 A per output,<br>Σ (Out) 4 A <sup>(3)</sup>       |         | 1 A per output,<br>Σ (Out) 2 A <sup>(8)</sup> |                               |
| <b>Display</b>   |   |   |   |         |   |                               |
| LED ASi (green)  | on: ASi voltage on<br>flashing: ASi voltage on, but peripheral fault <sup>(4)</sup> or address 0<br>off: no ASi voltage |   |   |         |   |                               |
| LED FLT/FAULT (red)                                      | on: slave address 0 or slave offline<br>flashing: peripheral fault <sup>(4)</sup><br>off: slave online                  |   |   |         |   |                               |
| LED AUX (green)  | on: 24 V <sub>DC</sub> AUX<br>off: no 24 V <sub>DC</sub> AUX  |   |   |         |   |                               |
| LEDs I1 ... I4 (yellow)                                  | state of inputs I1 ... I4   |   |   |         |   |                               |
| LEDs O1 ... O4 (yellow)                                  | state of outputs<br>O1 ... O3   | state of outputs<br>O1 ... O4                     | -   |         |   | state of outputs<br>O1 ... O4 |
| LEDs O1 ... O4 (yellow / red)                            | -   |   | yellow: state of outputs O1 ... O4<br>red: overload |         |   | -                             |

# Digital Modules ASi, IP67, M12



| Article No.  | BWU3496  | BWU3540 | BWU3426 | BWU2626 | BWU2617 | BWU2684 |
|--|--|---------|---------|---------|---------|---------|
| <b>Environment</b>                                 |  |         |         |         |         |         |
| Applied standards                                  | EN 61000-6-2<br>EN 61000-6-3<br>EN 61131-2<br>EN 60529           |         |         |         |         |         |
| Can be used in passively safe paths up to SIL3/PLe | yes <sup>(5)</sup>   |         |         |         |         |         |
| Operating altitude                                 | max. 2000 m  |         |         |         |         |         |
| Ambient temperature                                | -30 °C ... +55 °C <sup>(2)(3)(6)(8)</sup><br>(up to max. +70 °C) |         |         |         |         |         |
| Storage temperature                                | -30 °C ... +85 °C  |         |         |         |         |         |
| Housing  | plastic, for screw mounting                                      |         |         |         |         |         |
| Pollution degree                                   | 2  |         |         |         |         |         |
| Protection category                                | IP67 <sup>(7)</sup>  |         |         |         |         |         |
| Tolerable loading referring to humidity            | according to EN 61131-2  |         |         |         |         |         |
| Max. tolerable shock load                          | 30g, 11 ms, acc. EN 61131-2                                      |         |         |         |         |         |
| Max. tolerable vibration stress                    | 5 ... 8 Hz 50 mm <sub>pp</sub> /8 ... 500 Hz 6g, acc. EN 61131-2 |         |         |         |         |         |
| Insulation voltage                                 | ≥500 V   |         |         |         |         |         |
| Weight   | 200 g  |         |         |         |         |         |
| Dimensions (W / H / D) in mm                       | 60 / 151 / 31  |         |         |         |         |         |

(1) Loop resistance ≤150 Ω

(2)

**BWU2617, BWU2626, BWU3426, BWU2684, BWU3496, BWU3540**  
**Derating of power supply of attached sensors**

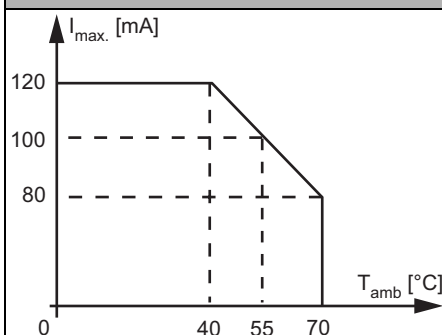

(3)

**BWU3426, BWU3496, BWU3540**  
**Derating output current per output**

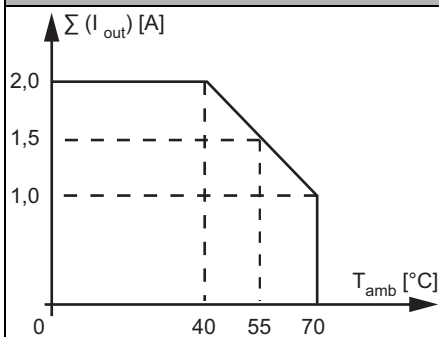

(4) See table "Peripheral fault indication"

(5) BWU3496 from Ident. No. 16960; BWU3540 from Ident. No. 17247; BWU3426 from Ident. No. 17830; BWU2617 from Ident. No. 16955; BWU2684 from Ident. No. 17245; the module is suitable for use in passively safe paths because an exclusion of errors can be assumed for the connection of the two potentials, ASi and AUX.

(6) Maximum ambient operating temperature +55 °C according UL certificate for the use in the USA and Canada

(7) Protection category IP67 can only be achieved if all open connections are sealed with suitable end caps fulfilling the same protection category.

# Digital Modules ASi, IP67, M12

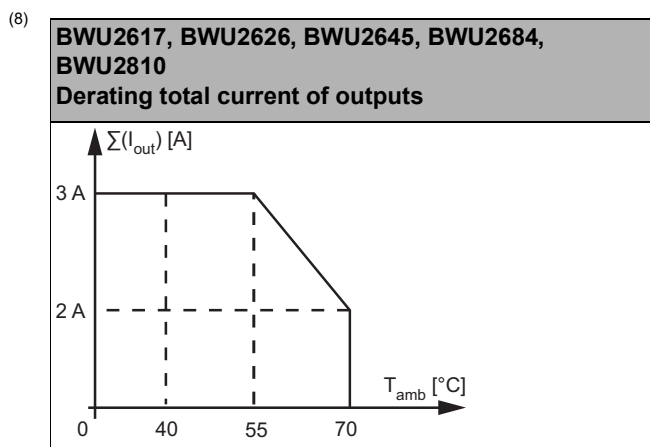

| Article No.  | BWU3892   |  | BWU2619               | BWU2652   |
|--|---|--|-----------------------|---|
| <b>General data</b>                                      |   |  |                       |   |
| Device type  | input / output  |  |                       | output  |
| <b>Connection</b>  |   |  |                       |   |
| ASi/AUX Connection                                       | profile cable and piercing  |  |                       |   |
| Periphery connection                                     | M12, Y-wiring   |  |                       |   |
| Length of connector cable                                | unlimited <sup>(1)</sup>  |  |                       |   |
| <b>ASi</b>   |   |  |                       |   |
| Profile  | slave 1: S-7.A.7 (ID1=7 fixed),<br>slave 2: S-7.A.7 (ID1=6 default) |  |                       |   |
| Address  | 2 AB slaves   |  |                       |   |
| Required Master profile                                  | ≥M4   |  |                       |   |
| As of ASi specification                                  | 3.0   |  |                       |   |
| Operating voltage  | 30 V (18 ... 31.6 V)  |  |                       |   |
| Max. current consumption                                 | 70 mA   | 270 mA   |                       | 60 mA   |
| Max. current consumption without sensor/ actuator supply | 70 mA   |  |                       | 60 mA   |
| <b>AUX</b>   |   |  |                       |   |
| Operating voltage  | 24 V (18 ... 30 V)  |  |                       |   |
| Max. current consumption                                 | 7 A   | 6 A  |                       |   |
| <b>Input</b>   |   |  |                       |   |
| Number   | 8   |  |                       | –   |
| Power supply   | out of AUX  | out of ASi   |                       | –   |
| Sensor supply  | short-circuit and overload protected according to EN 61131-2        |  |                       |   |
| Power supply of attached sensors                         | up to +40 °C  | 1 A <sup>(2)</sup>   | 200 mA <sup>(7)</sup> | –   |
|  | at +55 °C   |  | 150 mA <sup>(2)</sup> | –   |
|  | at +70 °C   | 0,5 A  | 100 mA <sup>(2)</sup> | –   |
| Switching threshold                                      | U<5 V (low)<br>U>15 V (high)  |  |                       | –   |
| <b>Output</b>  |   |  |                       |   |
| Number   | 8   |  |                       |   |
| Power supply   | out of AUX  |  |                       |   |
| Output   | short-circuit and overload protected according to EN 61131-2        |  |                       |   |
| Max. output current                                      | up to +40 °C  | 1 A per output,<br>Σ(O1...O4) 3 A + Σ (O5-O8) 3 A <sup>(3)</sup>           |                       | 1 A per output,<br>Σ (O1...O4) 3 A + Σ (O5...O8) 3 A <sup>(8)</sup> |
|  | at +55 °C   | 1 A per output,<br>Σ(O1...O4) 1,625 A + Σ(O5...O8) 1,625 A <sup>(3)</sup>  |                       |   |
|  | at +70 °C   | 0,25 A per output,<br>Σ(O1...O4) 0,25 A + Σ(O5...O8) 0,25 A <sup>(3)</sup> |                       | 1 A per output,<br>Σ (O1...O4) 2 A + Σ (O5...O8) 2 A <sup>(8)</sup> |

# Digital Modules ASi, IP67, M12

| Article No.  | BWU3892   | BWU2619   | BWU2652 |
|--|---|---|---------|
| <b>Display</b>                                     |   |   |         |
| LED ASI/FLT 1 (red/green)                          | green: slave online<br>red: slave offline<br>yellow/red flashing: address 0<br>red/green flashing: peripheral fault <sup>(4)</sup>  |   |         |
| LED ASI/FLT 2 (red/green)                          | green: slave online<br>red: slave offline<br>yellow/red flashing: address 0<br>red/green flashing: peripheral fault <sup>(4)</sup><br>red flashing: slave 2 is switched off, because slave 1 is offline |   |         |
| LED AUX (green)                                    | on: 24 V <sub>DC</sub> AUX<br>off: no 24 V <sub>DC</sub> AUX  |   |         |
| LEDs I1 / I2 ... In/In+1 (yellow)                  | state of inputs I1 / I2 ... I7 / I8:<br>at least 1 input of input pair is on  | -   |         |
| LEDs O1 ... On (yellow / red)                      | -   | yellow: state of outputs O1 ... O8<br>red: overload |         |
| LEDs O1/O2 ...<br>On / On+1 (yellow)               | state of outputs O1 / O2 ... O7 / O8:<br>at least 1 output of output pair is on   | -   |         |
| <b>Environment</b>                                 |   |   |         |
| Applied standards                                  | EN 61000-6-2<br>EN 61000-6-3<br>EN 61131-2<br>EN 60529  |   |         |
| Can be used in passively safe paths up to SIL3/PLe | no <sup>(4)</sup>   | yes <sup>(9)</sup>                                  |         |
| Operating altitude                                 | max. 2000 m   |   |         |
| Ambient temperature                                | -30 °C ... +55 °C <sup>(7)</sup> <sup>(3)</sup> <sup>(5)</sup> <sup>(8)</sup><br>(up to max. +70 °C)  |   |         |
| Storage temperature                                | -30 °C ... +85 °C   |   |         |
| Housing  | plastic, for screw mounting   |   |         |
| Pollution degree                                   | 2   |   |         |
| Protection category                                | IP67 <sup>(6)</sup>   |   |         |
| Tolerable loading referring to humidity            | according to EN 61131-2   |   |         |
| Max. tolerable shock load                          | 30g, 11 ms, acc. EN 61131-2   |   |         |
| Max. tolerable vibration stress                    | 5 ... 8 Hz 50 mm <sub>pp</sub> /8 ... 500 Hz 6g, acc. EN 61131-2  |   |         |
| Insulation voltage                                 | ≥500 V  |   |         |
| Weight   | 200 g   |   |         |
| Dimensions (W / H / D) in mm                       | 60 / 151 / 31   |   |         |

(1) Loop resistance ≤150 Ω

(2)

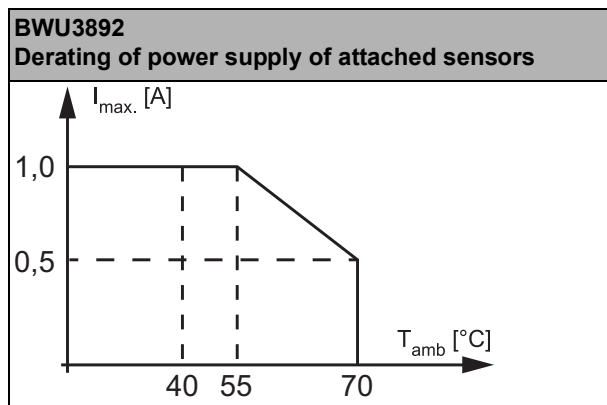

# Digital Modules ASi, IP67, M12

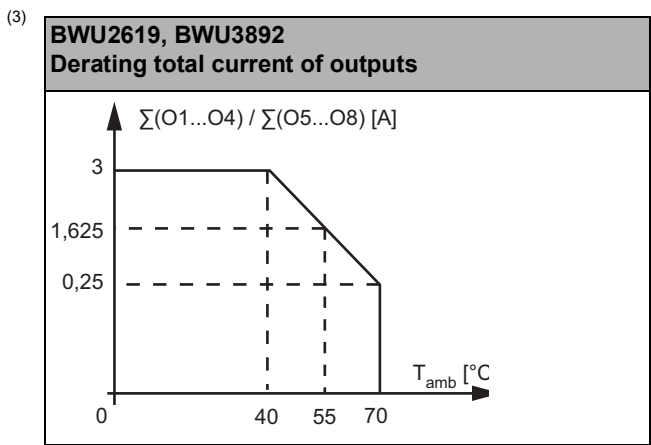

- (4) The module is not suitable for use in passively safe paths because an exclusion of errors cannot be assumed for the connection of the two potentials, ASi and AUX.
- (5) Maximum ambient operating temperature +55 °C according UL certificate for the use in the USA and Canada
- (6) Protection category IP67 can only be achieved if all open connections are sealed with suitable end caps fulfilling the same protection category.

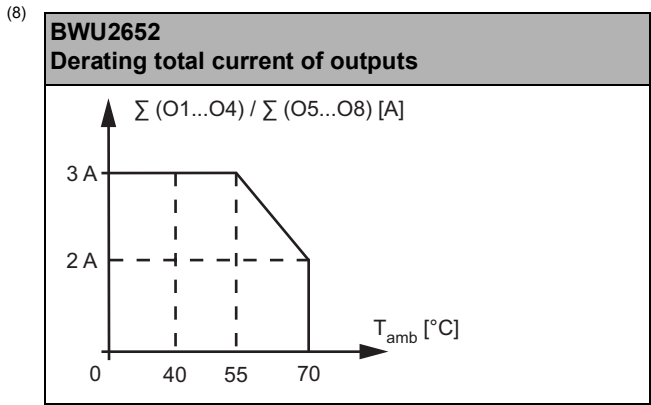
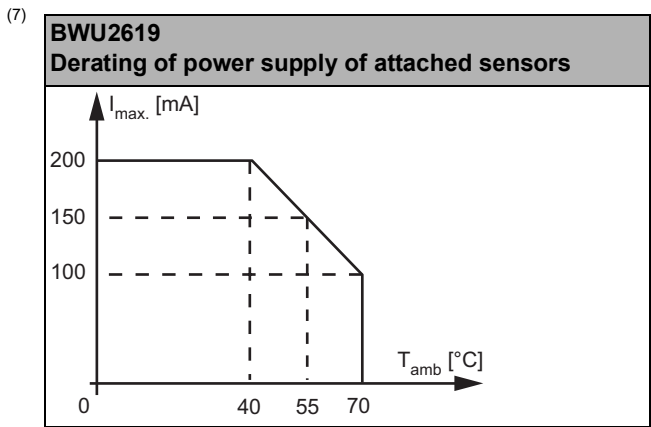

- (9) BWU2652 from Ident. No. 18263; The module is suitable for use in passively safe paths because an exclusion of errors can be assumed for the connection of the two potentials, ASi and AUX.

| Article No.               | BWU3510                    | BWU2810            | BWU2645            |
|---------------------------|----------------------------|--------------------|--------------------|
| <b>General data</b>       |                            |                    |                    |
| Device type               | input / output             |                    |                    |
| <b>Connection</b>         |                            |                    |                    |
| ASi/AUX Connection        | profile cable and piercing |                    | M12 <sup>(7)</sup> |
| Periphery connection      | M12, Y-wiring              | M12, single-wiring |                    |
| Length of connector cable | unlimited <sup>(1)</sup>   |                    |                    |

# Digital Modules ASi, IP67, M12



| Article No.  | BWU3510   | BWU2810                                      | BWU2645 |
|--|---|--|---------|
| <b>ASi</b>   |   |  |         |
| Profile  | S-7.A.7 (ID1=7 fixed)   |  |         |
| Address  | 1 AB slave  |  |         |
| Required Master profile                                  | ≥M4   |  |         |
| As of ASi specification                                  | 3.0   |  |         |
| Operating voltage  | 30 V (18 ... 31.6 V)  |  |         |
| Max. current consumption                                 | 35 mA   |  |         |
| Max. current consumption without sensor/ actuator supply | 35 mA   |  |         |
| <b>AUX</b>   |   |  |         |
| Operating voltage  | 24 V (18 ... 30 V)  |  |         |
| Max. current consumption                                 | 3 A   |  |         |
| <b>Input</b>   |   |  |         |
| Number   | 4   |  |         |
| Power supply   | out of AUX  |  |         |
| Sensor supply  | short-circuit and overload protected according to EN 61131-2  |  |         |
| Power supply of attached sensors                         | up to +40 °C  | max. 1 A                                     |         |
|  | at +55 °C   |  |         |
|  | at +70 °C   |  |         |
| Switching threshold                                      | U<5 V (low)<br>U>15 V (high)  |  |         |
| <b>Output</b>  |   |  |         |
| Number   | 4   |  |         |
| Power supply   | out of AUX  |  |         |
| Output   | short-circuit and overload protected according to EN 61131  |  |         |
| Max. output current                                      | up to +40 °C  | 1 A per output,<br>Σ(Out) 3 A <sup>(2)</sup> |         |
|  | at +55 °C   |  |         |
|  | at +70 °C   |  |         |
| <b>Display</b>   |   |  |         |
| LED ASi (green)  | on: ASi voltage on<br>flashing: ASi voltage on, but peripheral fault <sup>(3)</sup> or address 0<br>off: no ASi voltage |  |         |
| LED FLT/FAULT (red)                                      | on: slave address 0 or slave offline<br>flashing: peripheral fault <sup>(4)</sup><br>off: slave online                  |  |         |
| LED AUX (green)  | on: 24 V <sub>DC</sub> AUX<br>off: no 24 V <sub>DC</sub> AUX  |  |         |
| LEDs I1 ... I4 (yellow)                                  | state of inputs I1 ... I4   |  |         |
| LEDs O1 ... O4 (yellow / red)                            | yellow: state of outputs O1 ... O4<br>red: overload   |  |         |

# Digital Modules ASi, IP67, M12

| Article No.  | BWU3510  | BWU2810 | BWU2645 |
|--|--|---------|---------|
| <b>Environment</b>                                 |  |         |         |
| Applied standards                                  | EN 61000-6-2<br>EN 61000-6-3<br>EN 61131-2<br>EN 60529           |         |         |
| Can be used in passively safe paths up to SIL3/PLe | yes <sup>(4)</sup>   |         |         |
| Operating altitude                                 | max. 2000 m  |         |         |
| Ambient temperature                                | -30 °C ... +55 °C <sup>(2)(5)</sup><br>(up to max. +70 °C)       |         |         |
| Storage temperature                                | -30 °C ... +85 °C  |         |         |
| Housing  | plastic, for screw mounting                                      |         |         |
| Pollution degree                                   | 2  |         |         |
| Protection category                                | IP67 <sup>(6)</sup>  |         |         |
| Tolerable loading referring to humidity            | according to EN 61131-2  |         |         |
| Max. tolerable shock load                          | 30g, 11 ms, acc. EN 61131-2                                      |         |         |
| Max. tolerable vibration stress                    | 5 ... 8 Hz 50 mm <sub>pp</sub> /8 ... 500 Hz 6g, acc. EN 61131-2 |         |         |
| Insulation voltage                                 | ≥500 V   |         |         |
| Weight   | 200 g  |         |         |
| Dimensions (W / H / D) in mm                       | 60 / 151 / 31  |         |         |

(1) Loop resistance ≤150 Ω

(2)

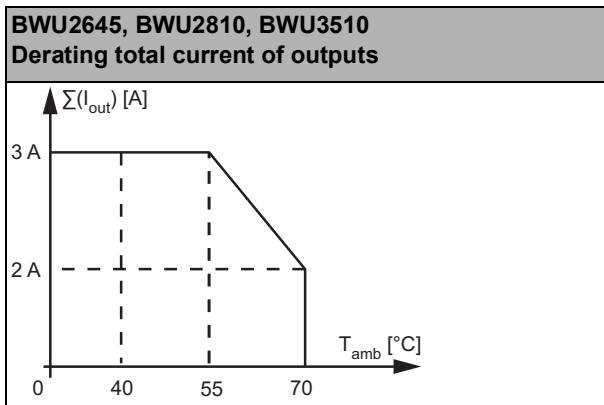

(3) See table "Peripheral fault indication"

(4) BWU3510 from Ident. No. 18000; BWU2810 from Ident. No. 17248; BWU2645 from Ident. No. 17249; the module is suitable for use in passively safe paths because an exclusion of errors can be assumed for the connection of the two potentials, ASi and AUX.

(5) Maximum ambient operating temperature +55 °C according UL certificate for the use in the USA and Canada

(6) Protection category IP67 can only be achieved if all open connections are sealed with suitable end caps fulfilling the same protection category.

# Digital Modules ASi, IP67, M12



**(7) Line protection:**

If the module is supplied via a M12 connection with A or B coding, it may only be used with a current load of max. 4 A per pin in acc. with IEC 61076-2-101 and IEC 61076-2-109. A fused tap is recommended. There is no such limitation for modules supplied via piercing contacts.

**Connection to ASi and AUX via M12**

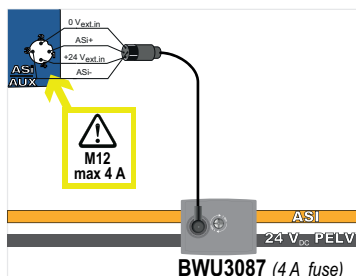

**via piercing contacts**

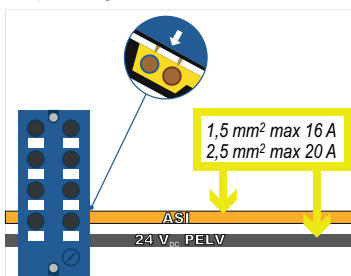

| Article No.  | BWU2713   |  | BWU2594               | BWU2728  |
|--|---|--|-----------------------|--|
| <b>General data</b>                                      |   |  |                       |  |
| Device type  | output  |  |                       |  |
| <b>Connection</b>  |   |  |                       |  |
| ASi/AUX Connection                                       | profile cable and piercing  |  |                       |  |
| Periphery connection                                     | M12, Y-wiring   |  |                       |  |
| Length of connector cable                                | unlimited <sup>(1)</sup>  |  |                       |  |
| <b>ASi</b>   |   |  |                       |  |
| Profile  | S-7.F.E (ID1=F default)   |  | S-7.A.7 (ID1=7 fixed) |  |
| Address  | 1 single slave  |  | 1 AB slave            |  |
| Required Master profile                                  | ≥M0   |  | ≥M4                   |  |
| As of ASi specification                                  | 2   |  | 3                     |  |
| Operating voltage  | 30 V (18 ... 31.6 V)  |  |                       |  |
| Max. current consumption                                 | 35 mA   |  |                       |  |
| Max. current consumption without sensor/ actuator supply | 35 mA   |  |                       |  |
| <b>AUX</b>   |   |  |                       |  |
| Operating voltage  | 24 V (18 ... 30 V)  |  |                       |  |
| Max. current consumption                                 | 3 A   |  | 8 A                   |  |
| <b>Output</b>  |   |  |                       |  |
| Number   | 4   |  |                       |  |
| Power supply   | out of AUX  |  |                       |  |
| Output   | short-circuit and overload protected according to EN 61131  |  |                       |  |
| Max. output current                                      | up to +40 °C  | 1 A per output<br>Σ (Out) 3 A <sup>(2)</sup> |                       | 2 A per output,<br>Σ (Out) 8 A <sup>(9) (10)</sup> |
|  | at +55 °C   |  |                       | 2 A per output,<br>Σ (Out) 4 A <sup>(9) (10)</sup> |
|  | at +70 °C   | 1 A per output<br>Σ (Out) 2 A <sup>(2)</sup> |                       | –  |
| <b>Display</b>   |   |  |                       |  |
| LED ASi (green)  | on: ASi voltage on<br>flashing: ASi voltage on, but peripheral fault <sup>(3)</sup> or address 0<br>off: no ASi voltage |  |                       |  |
| LED FLT/FAULT (red)                                      | on: slave address 0 or slave offline<br>flashing: peripheral fault <sup>(3)</sup><br>off: slave online                  |  |                       |  |
| LED AUX (green)  | on: 24 V <sub>DC</sub> AUX<br>off: no 24 V <sub>DC</sub> AUX  |  |                       |  |
| LEDs O1 ... On (yellow / red)                            | yellow: state of outputs O1 ... O4<br>red: overload   |  |                       |  |

# Digital Modules ASi, IP67, M12

| Article No.  | BWU2713   | BWU2594           | BWU2728             |
|--|---|-------------------|---------------------|
| <b>Environment</b>                                 |   |                   |                     |
| Applied standards                                  | EN 61000-6-2<br>EN 61000-6-3<br>EN 61131-2<br>EN 60529                                |                   |                     |
| Can be used in passively safe paths up to SIL3/PLe | yes <sup>(4)</sup>  | no <sup>(8)</sup> | yes <sup>(11)</sup> |
| Operating altitude                                 | max. 2000 m   |                   |                     |
| Ambient temperature                                | -30 °C ... +55 °C<br>(up to max. +70 °C) <sup>(2)</sup> <sup>(5)</sup> <sup>(9)</sup> |                   |                     |
| Storage temperature                                | -30 °C ... +85 °C   |                   |                     |
| Housing  | plastic, for DIN rail mounting or<br>for screw mounting <sup>(6)</sup>                |                   |                     |
| Pollution degree                                   | 2   |                   |                     |
| Protection category                                | IP67 <sup>(7)</sup>   |                   |                     |
| Tolerable loading referring to humidity            | according to EN 61131-2   |                   |                     |
| Max. tolerable shock load                          | 30g, 11 ms, acc. EN 61131-2   |                   |                     |
| Max. tolerable vibration stress                    | 5 ... 8 Hz 50 mm <sub>pp</sub> /8 ... 500 Hz 6g, acc. EN 61131-2                      |                   |                     |
| Insulation voltage                                 | ≥500 V  |                   |                     |
| Weight   | 100 g   |                   |                     |
| Dimensions (W / H / D) in mm                       | 45 / 80 / 42  |                   |                     |

(1) Loop resistance ≤150 Ω

(2)

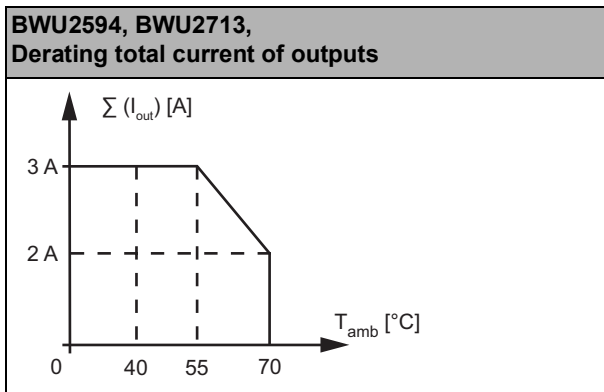

(3) See table "Peripheral fault indication"

(4) BWU2713 from ID no. 18595; The module is suitable for use in passively safe paths because an exclusion of errors can be assumed for the connection of the two potentials, ASi and AUX.

(5) Maximum ambient operating temperature +55 °C according UL certificate for the use in the USA and Canada.

(6) Depending on substructure module (see accessories). The substructure module is not included in the scope of delivery.

(7) Protection category IP67 can only be achieved if all open connections are sealed with suitable end caps fulfilling the same protection category.

(8) The module is not suitable for use in passively safe paths because an exclusion of errors cannot be assumed for the connection of the two potentials, ASi and AUX.

# Digital Modules ASi, IP67, M12

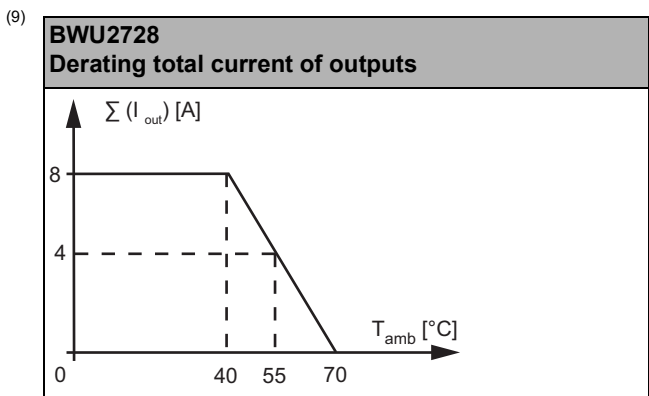

- (10) To power consumers whose current draw is greater than 2A, two or more outputs can be combined with each other. The data bits of the bundled outputs must be set at the same time.
- (11) BWU2728 from Ident. No. 17399; the module is suitable for use in passively safe paths because an exclusion of errors can be assumed for the connection of the two potentials, ASi and AUX.

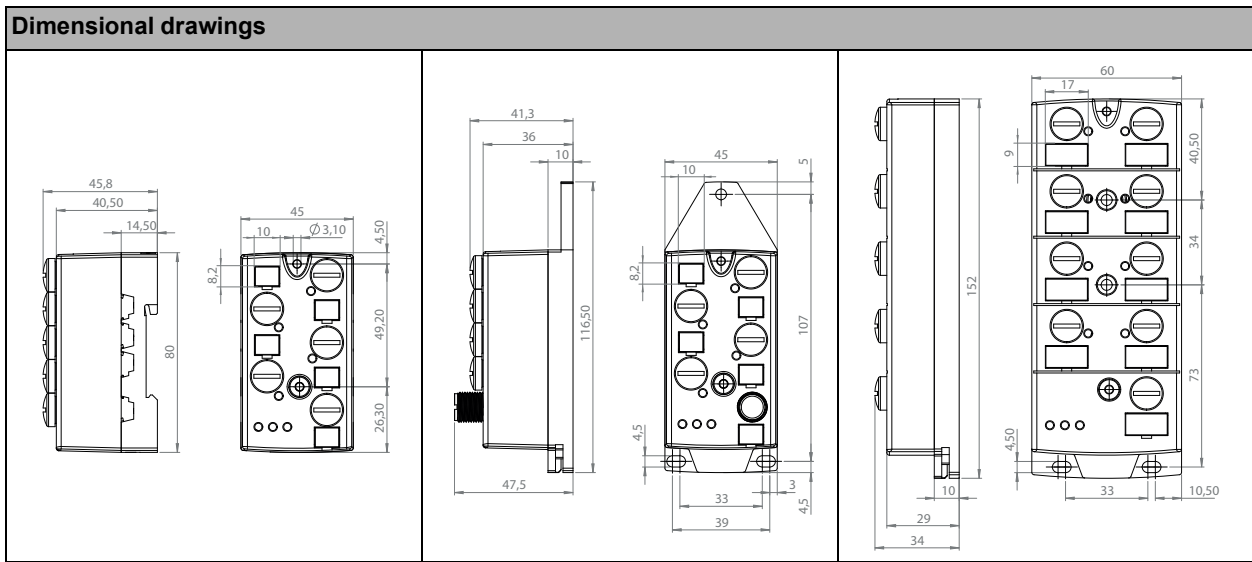

**UL-specifications (UL508)**  
**BWU2547, BWU2552, BWU2594, BWU2617, BWU2619, BWU2620, BWU2626, BWU3426, BWU2645, BWU2651, BWU2652, BWU2684, BWU2713, BWU2725, BWU2728, BWU2767, BWU2770, BWU2810, BWU2983, BWU3032, BWU3077, BWU3141, BWU3240, BWU3375, BWU3539, BWU3456, BWU3457, BWU3496, BWU3510, BWU3517, BWU3540, BWU3556, BWU3775, BWU3887, BWU3892**

|                     |   |
|---------------------|---|
| External protection | An isolated source with a secondary open circuit voltage of $\leq 30 V_{DC}$ with a 3 A maximum over current protection. Over current protection is not required when a Class 2 source is employed. |
| In general          | UL mark does not provide UL certification for any functional safety rating or aspects of the above devices.   |

# Digital Modules ASi, IP67, M12



| Article no. | Peripheral fault indication |                        |                     |
|-------------|-----------------------------|------------------------|---------------------|
|             | Overload sensor supply      | Output short circuited | AUX voltage missing |
| BWU2487     | •                           | –                      | –                   |
| BWU2547     | –                           | –                      | •                   |
| BWU2552     | •                           | –                      | –                   |
| BWU2594     | •                           | •                      | •                   |
| BWU2617     | •                           | •                      | –                   |
| BWU2619     | •                           | •                      | –                   |
| BWU2620     | •                           | –                      | –                   |
| BWU2626     | •                           | •                      | –                   |
| BWU3426     | •                           | –                      | –                   |
| BWU2645     | •                           | •                      | –                   |
| BWU2651     | •                           | –                      | –                   |
| BWU2652     | •                           | •                      | •                   |
| BWU2684     | •                           | •                      | –                   |
| BWU2713     | •                           | •                      | •                   |
| BWU2725     | •                           | –                      | •                   |
| BWU2728     | •                           | •                      | •                   |
| BWU2767     | •                           | –                      | •                   |
| BWU2770     | •                           | –                      | •                   |
| BWU2810     | •                           | •                      | –                   |
| BWU2983     | •                           | –                      | –                   |
| BWU3032     | •                           | –                      | –                   |
| BWU3077     | •                           | –                      | –                   |
| BWU3141     | •                           | •                      | •                   |
| BWU3240     | •                           | –                      | –                   |
| BWU3375     | •                           | –                      | –                   |
| BWU3539     | •                           | •                      | –                   |
| BWU3456     | •                           | •                      | •                   |
| BWU3457     | •                           | –                      | –                   |
| BWU3496     | •                           | –                      | –                   |
| BWU3510     | •                           | •                      | –                   |
| BWU3517     | •                           | •                      | •                   |
| BWU3540     | •                           | –                      | –                   |
| BWU3556     | •                           | –                      | –                   |
| BWU3775     | •                           | •                      | –                   |
| BWU3887     | –                           | –                      | •                   |
| BWU3892     | •                           | •                      | –                   |

# Digital Modules ASi, IP67, M12



| Programming  | ASi bit assignment         |                            |                            |                            |
|--|----------------------------|----------------------------|----------------------------|----------------------------|
| Bit  | D3                         | D2                         | D1                         | D0                         |
|  | <b>input</b>               |                            |                            |                            |
| BWU2487 / BWU2547 /<br>BWU2552 / BWU2617 /<br>BWU2620 / BWU2626 /<br>BWU3426 / BWU2645 /<br>BWU2684 / BWU2725 /<br>BWU2767 / BWU2810 /<br>BWU3032 / BWU3077 /<br>BWU3240 /<br>BWU3375 / BWU3496 /<br>BWU3510 / BWU3556 /<br>BWU3540 / BWU3457 /<br>BWU3887 | I4                         | I3                         | I2                         | I1                         |
| BWU3141 / BWU3456<br>BWU3539 / BWU3517 /<br>BWU3775  | –                          | –                          | I2                         | I1                         |
| BWU2619 / BWU2651 /<br>BWU2770 / BWU2983 /<br>BWU3892  | slave 1: I4<br>slave 2: I8 | slave 1: I3<br>slave 2: I7 | slave 1: I2<br>slave 2: I6 | slave 1: I1<br>slave 2: I5 |
|  | <b>output</b>              |                            |                            |                            |
| BWU2487 / BWU2547 /<br>BWU2594 / BWU2617 /<br>BWU2626 / BWU3426 /<br>BWU2645 / BWU2684 /<br>BWU2713 / BWU2728 /<br>BWU2810 / BWU3032 /<br>BWU3240 / BWU3510 /<br>BWU3540 / BWU3887   | O4                         | O3                         | O2                         | O1                         |
| BWU2767 / BWU3141 /<br>BWU3456 / BWU3517   | –                          | –                          | O2                         | O1                         |
| BWU3539 / BWU3775  | O4                         | O3                         | –                          | –                          |
| BWU3375 / BWU3496  | –                          | O3                         | O2                         | O1                         |
| BWU2619 / BWU2652 /<br>BWU3892   | slave 1: O4<br>slave 2: O8 | slave 1: O3<br>slave 2: O7 | slave 1: O2<br>slave 2: O6 | slave 1: O1<br>slave 2: O5 |

| Programming   | Parameter bits |  |   |                                 |
|---|----------------|--|---|---------------------------------|
| Bit   | P3             | P2                                       | P1  | P0                              |
| BWU2652   | not used       | 0= on / 1= off<br>(synchronous I/O mode) | –   | not used,<br>Watchdog always on |
| BWU2594 / BWU2713<br>BWU2728  |                |  | 0= off / 1= on<br>(peripheral fault,<br>if AUX missing) | 0= off / 1= on<br>(Watchdog)    |
| BWU2487 / BWU2547 /<br>BWU2617 / BWU2626 /<br>BWU3426 / BWU2645 /<br>BWU2684 / BWU2767 /<br>BWU2810 / BWU3032 /<br>BWU3141 /<br>BWU3240 / BWU3375 /<br>BWU3456 / BWU3539 /<br>BWU3496 / BWU3510 /<br>BWU3517 / BWU3540 /<br>BWU3775 / BWU3887 |                |  | 0= on / 1= off<br>(data input filter 128µs)             |                                 |
| BWU2552 / BWU2620 /<br>BWU2651 / BWU2725 /<br>BWU2770 / BWU2983 /<br>BWU3077 / BWU3457<br>BWU3556   |                |  | 0= off / 1= on<br>(peripheral fault)                    |                                 |
| BWU2619 / BWU3892   |                |  | not used,<br>Watchdog always on                         |                                 |

# Digital Modules ASi, IP67, M12

## Pin assignment

| Signal name               | Explanation   |
|---------------------------|---|
| Ix                        | digital input x   |
| Ox                        | digital output x  |
| 24V <sub>ext out</sub>    | power supply, out of external voltage, positive pole (AUX, actuator supply) |
| 0V <sub>ext out</sub>     | power supply, out of external voltage, negative pole (AUX, actuator supply) |
| 24V <sub>out of ASi</sub> | power supply, out of ASi, positive pole (sensor supply)                     |
| 0V <sub>out of ASi</sub>  | power supply, out of ASi, negative pole (sensor supply)                     |
| ASi +, ASi -              | connection to ASi bus   |
| n.c. (not connected)      | not connected   |

| Connections        |                   |                                      |                            |      |                           |      |      |
|--------------------|-------------------|--------------------------------------|----------------------------|------|---------------------------|------|------|
| Article no.        | M12 connection    | Marking                              | Pin1                       | Pin2 | Pin3                      | Pin4 | Pin5 |
| BWU3141            | X1                | I1                                   | 24 V <sub>out of ASi</sub> | n.c. | 0 V <sub>out of ASi</sub> | I1   | n.c. |
|                    | X2                | O1                                   | 24 V <sub>ext out</sub>    | n.c. | 0 V <sub>ext out</sub>    | O1   | n.c. |
|                    | X3                | I2                                   | 24 V <sub>out of ASi</sub> | n.c. | 0 V <sub>out of ASi</sub> | I2   | n.c. |
|                    | X4                | O2                                   | 24 V <sub>ext out</sub>    | n.c. | 0 V <sub>ext out</sub>    | O2   | n.c. |
|                    | ADDR (dummy plug) | connection for ASi addressing device |                            |      |                           |      |      |
| BWU3456            | X1                | I1                                   | 24 V <sub>out of ASi</sub> | I2   | 0 V <sub>out of ASi</sub> | I1   | n.c. |
|                    | X2                | O1                                   | 24 V <sub>ext out</sub>    | O2   | 0 V <sub>ext out</sub>    | O1   | n.c. |
|                    | X3                | I2                                   | 24 V <sub>out of ASi</sub> | n.c. | 0 V <sub>out of ASi</sub> | I2   | n.c. |
|                    | X4                | O2                                   | 24 V <sub>ext out</sub>    | n.c. | 0 V <sub>ext out</sub>    | O2   | n.c. |
|                    | ADDR (dummy plug) | connection for ASi addressing device |                            |      |                           |      |      |
| BWU3539<br>BWU3775 | X1                | I1                                   | 24 V <sub>out of ASi</sub> | I2   | 0 V <sub>out of ASi</sub> | I1   | n.c. |
|                    | X2                | O3                                   | 24 V <sub>ext out</sub>    | O4   | 0 V <sub>ext out</sub>    | O3   | n.c. |
|                    | X3                | I2                                   | 24 V <sub>out of ASi</sub> | n.c. | 0 V <sub>out of ASi</sub> | I2   | n.c. |
|                    | X4                | O4                                   | 24 V <sub>ext out</sub>    | n.c. | 0 V <sub>ext out</sub>    | O4   | n.c. |
|                    | ADDR (dummy plug) | connection for ASi addressing device |                            |      |                           |      |      |
| BWU2487            | X1                | I1/I2                                | 24 V <sub>out of ASi</sub> | I2   | 0 V <sub>out of ASi</sub> | I1   | n.c. |
|                    | X2                | O1/O2                                | 24 V <sub>ext out</sub>    | O2   | 0 V <sub>ext out</sub>    | O1   | n.c. |
|                    | X3                | I3/I4                                | 24 V <sub>out of ASi</sub> | I4   | 0 V <sub>out of ASi</sub> | I3   | n.c. |
|                    | X4                | O3/O4                                | 24 V <sub>ext out</sub>    | O4   | 0 V <sub>ext out</sub>    | O3   | n.c. |
|                    | ADDR (dummy plug) | connection for ASi addressing device |                            |      |                           |      |      |
| BWU3032            | X1                | I1/I2                                | 24 V <sub>ext out</sub>    | I2   | 0 V <sub>ext out</sub>    | I1   | n.c. |
|                    | X2                | O1/O2                                | 24 V <sub>ext out</sub>    | O2   | 0 V <sub>ext out</sub>    | O1   | n.c. |
|                    | X3                | I3/I4                                | 24 V <sub>ext out</sub>    | I4   | 0 V <sub>ext out</sub>    | I3   | n.c. |
|                    | X4                | O3/O4                                | 24 V <sub>ext out</sub>    | O4   | 0 V <sub>ext out</sub>    | O3   | n.c. |
|                    | ADDR (dummy plug) | connection for ASi addressing device |                            |      |                           |      |      |
| BWU3375            | X1                | I1/I2                                | 24 V <sub>out of ASi</sub> | I2   | 0 V <sub>out of ASi</sub> | I1   | n.c. |
|                    | X2                | O1/O2                                | 24 V <sub>ext out</sub>    | O2   | 0 V <sub>ext out</sub>    | O1   | n.c. |
|                    | X3                | I3/I4                                | 24 V <sub>out of ASi</sub> | I4   | 0 V <sub>out of ASi</sub> | I3   | n.c. |
|                    | X4                | O3                                   | 24 V <sub>ext out</sub>    | n.c. | 0 V <sub>ext out</sub>    | O3   | n.c. |
|                    | ADDR (dummy plug) | connection for ASi addressing device |                            |      |                           |      |      |
| BWU2547            | X1                | I1/O1                                | 24 V <sub>ext out</sub>    | O1   | 0 V <sub>ext out</sub>    | I1   | n.c. |
|                    | X2                | I2/O2                                | 24 V <sub>ext out</sub>    | O2   | 0 V <sub>ext out</sub>    | I2   | n.c. |
|                    | X3                | I3/O3                                | 24 V <sub>ext out</sub>    | O3   | 0 V <sub>ext out</sub>    | I3   | n.c. |
|                    | X4                | I4/O4                                | 24 V <sub>ext out</sub>    | O4   | 0 V <sub>ext out</sub>    | I4   | n.c. |
|                    | ADDR (dummy plug) | connection for ASi addressing device |                            |      |                           |      |      |

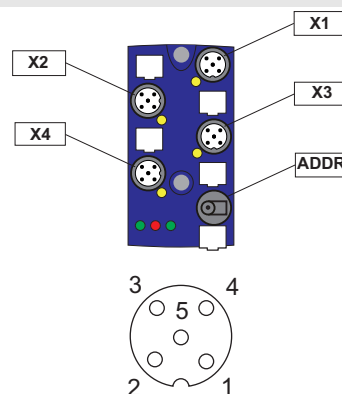

# Digital Modules ASi, IP67, M12



| Connections                   |                   |                                      |                            |      |                           |      |      |
|-------------------------------|-------------------|--------------------------------------|----------------------------|------|---------------------------|------|------|
| Article no.                   | M12 connection    | Marking                              | Pin1                       | Pin2 | Pin3                      | Pin4 | Pin5 |
| BWU3887                       | X1                | I1/O1                                | 24 V <sub>ext out</sub>    | I1   | 0 V <sub>ext out</sub>    | O1   | n.c. |
|                               | X2                | I2/O2                                | 24 V <sub>ext out</sub>    | I2   | 0 V <sub>ext out</sub>    | O2   | n.c. |
|                               | X3                | I3/O3                                | 24 V <sub>ext out</sub>    | I3   | 0 V <sub>ext out</sub>    | O3   | n.c. |
|                               | X4                | I4/O4                                | 24 V <sub>ext out</sub>    | I4   | 0 V <sub>ext out</sub>    | O4   | n.c. |
|                               | ADDR (dummy plug) | connection for ASi addressing device |                            |      |                           |      |      |
| BWU2767                       | X1                | I1/O1                                | 24 V <sub>ext out</sub>    | O1   | 0 V <sub>ext out</sub>    | I1   | n.c. |
|                               | X2                | I2/O2                                | 24 V <sub>ext out</sub>    | O2   | 0 V <sub>ext out</sub>    | I2   | n.c. |
|                               | X3                | I3                                   | 24 V <sub>ext out</sub>    | n.c. | 0 V <sub>ext out</sub>    | I3   | n.c. |
|                               | X4                | I4                                   | 24 V <sub>ext out</sub>    | n.c. | 0 V <sub>ext out</sub>    | I4   | n.c. |
|                               | ADDR (dummy plug) | connection for ASi addressing device |                            |      |                           |      |      |
| BWU2594<br>BWU2713<br>BWU2728 | X1                | O1                                   | 0 V <sub>ext out</sub>     | O2   | 0 V <sub>ext out</sub>    | O1   | n.c. |
|                               | X2                | O2                                   | 0 V <sub>ext out</sub>     | n.c. | 0 V <sub>ext out</sub>    | O2   | n.c. |
|                               | X3                | O3                                   | 0 V <sub>ext out</sub>     | O4   | 0 V <sub>ext out</sub>    | O3   | n.c. |
|                               | X4                | O4                                   | 0 V <sub>ext out</sub>     | n.c. | 0 V <sub>ext out</sub>    | O4   | n.c. |
|                               | ADDR (dummy plug) | connection for ASi addressing device |                            |      |                           |      |      |
| BWU2552                       | X1                | I1                                   | 24 V <sub>out of ASi</sub> | I2   | 0 V <sub>out of ASi</sub> | I1   | n.c. |
|                               | X2                | I2                                   | 24 V <sub>out of ASi</sub> | n.c. | 0 V <sub>out of ASi</sub> | I2   | n.c. |
|                               | X3                | I3                                   | 24 V <sub>out of ASi</sub> | I4   | 0 V <sub>out of ASi</sub> | I3   | n.c. |
|                               | X4                | I4                                   | 24 V <sub>out of ASi</sub> | n.c. | 0 V <sub>out of ASi</sub> | I4   | n.c. |
|                               | ADDR (dummy plug) | connection for ASi addressing device |                            |      |                           |      |      |
| BWU2620<br>BWU3556            | X1                | I1                                   | 24 V <sub>out of ASi</sub> | n.c. | 0 V <sub>out of ASi</sub> | I1   | n.c. |
|                               | X2                | I2                                   | 24 V <sub>out of ASi</sub> | n.c. | 0 V <sub>out of ASi</sub> | I2   | n.c. |
|                               | X3                | I3                                   | 24 V <sub>out of ASi</sub> | n.c. | 0 V <sub>out of ASi</sub> | I3   | n.c. |
|                               | X4                | I4                                   | 24 V <sub>out of ASi</sub> | n.c. | 0 V <sub>out of ASi</sub> | I4   | n.c. |
|                               | ADDR (dummy plug) | connection for ASi addressing device |                            |      |                           |      |      |
| BWU3457                       | X1                | I1                                   | 24 V <sub>out of ASi</sub> | n.c. | 0 V <sub>out of ASi</sub> | I1   | n.c. |
|                               | X2                | I2                                   | 24 V <sub>out of ASi</sub> | n.c. | 0 V <sub>out of ASi</sub> | I2   | n.c. |
|                               | X3                | I3                                   | 24 V <sub>out of ASi</sub> | n.c. | 0 V <sub>out of ASi</sub> | I3   | n.c. |
|                               | X4                | I4                                   | 24 V <sub>out of ASi</sub> | n.c. | 0 V <sub>out of ASi</sub> | I4   | n.c. |
|                               | X5                | ASi                                  | ASi+                       | n.c. | ASi-                      | n.c. | -    |
| BWU2725                       | X1                | I1                                   | 24 V <sub>ext out</sub>    | n.c. | 0 V <sub>ext out</sub>    | I1   | n.c. |
|                               | X2                | I2                                   | 24 V <sub>ext out</sub>    | n.c. | 0 V <sub>ext out</sub>    | I2   | n.c. |
|                               | X3                | I3                                   | 24 V <sub>ext out</sub>    | n.c. | 0 V <sub>ext out</sub>    | I3   | n.c. |
|                               | X4                | I4                                   | 24 V <sub>ext out</sub>    | n.c. | 0 V <sub>ext out</sub>    | I4   | n.c. |
|                               | ADDR (dummy plug) | connection for ASi addressing device |                            |      |                           |      |      |
| BWU3077                       | X1                | I1                                   | 24 V <sub>out of ASi</sub> | I2   | 0 V <sub>out of ASi</sub> | I1   | n.c. |
|                               | X2                | I2                                   | 24 V <sub>out of ASi</sub> | n.c. | 0 V <sub>out of ASi</sub> | I2   | n.c. |
|                               | X3                | I3                                   | 24 V <sub>out of ASi</sub> | I4   | 0 V <sub>out of ASi</sub> | I3   | n.c. |
|                               | X4                | I4                                   | 24 V <sub>out of ASi</sub> | n.c. | 0 V <sub>out of ASi</sub> | I4   | n.c. |
|                               | X5                | ASi                                  | ASi+                       | n.c. | ASi-                      | n.c. | -    |

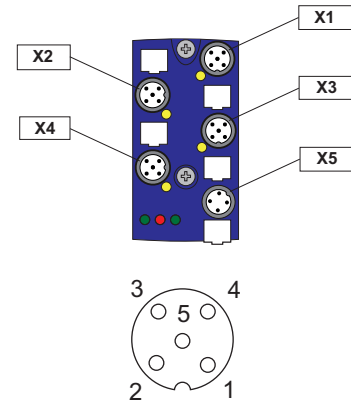
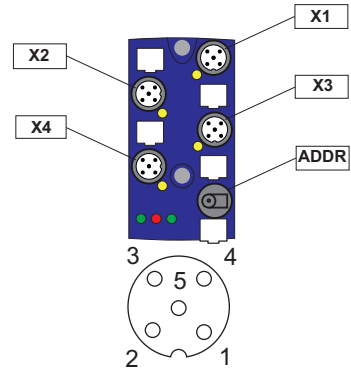

# Digital Modules ASi, IP67, M12



| Connections |                   |                                      |                            |                       |                           |                        |      |
|-------------|-------------------|--------------------------------------|----------------------------|-----------------------|---------------------------|------------------------|------|
| Article no. | M12 connection    | Marking                              | Pin1                       | Pin2                  | Pin3                      | Pin4                   | Pin5 |
| BWU3240     | X1                | I1/O1                                | 24 V <sub>out</sub> of ASi | O1                    | 0 V <sub>out</sub> of ASi | I1                     | n.c. |
|             | X2                | I2/O2                                | 24 V <sub>out</sub> of ASi | O2                    | 0 V <sub>out</sub> of ASi | I2                     | n.c. |
|             | X3                | I3/O3                                | 24 V <sub>out</sub> of ASi | O3                    | 0 V <sub>out</sub> of ASi | I3                     | n.c. |
|             | X4                | I4/O4                                | 24 V <sub>out</sub> of ASi | O4                    | 0 V <sub>out</sub> of ASi | I4                     | n.c. |
|             | ADDR (dummy plug) | connection for ASi addressing device |                            |                       |                           |                        |      |
| BWU3517     | X1                | I1                                   | 24 V <sub>out</sub> of ASi | n.c.                  | 0 V <sub>out</sub> of ASi | I1                     | n.c. |
|             | X2                | O1                                   | 24 V <sub>ext</sub> out    | n.c.                  | 0 V <sub>ext</sub> out    | O1                     | n.c. |
|             | X3                | I2                                   | 24 V <sub>out</sub> of ASi | n.c.                  | 0 V <sub>out</sub> of ASi | I2                     | n.c. |
|             | X4                | O2                                   | 24 V <sub>ext</sub> out    | n.c.                  | 0 V <sub>ext</sub> out    | O2                     | n.c. |
|             | X5                | ASi                                  | ASi+                       | 0 V <sub>ext</sub> in | ASi-                      | 24 V <sub>ext</sub> in | -    |

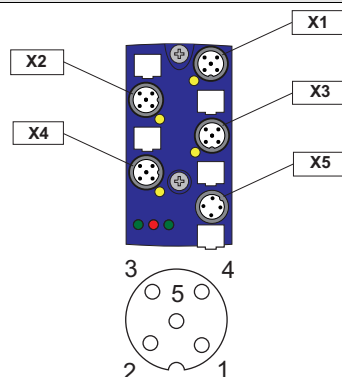

| Connections        |                   |                                      |                            |      |                           |      |      |
|--------------------|-------------------|--------------------------------------|----------------------------|------|---------------------------|------|------|
| Article no.        | M12 connection    | Marking                              | Pin1                       | Pin2 | Pin3                      | Pin4 | Pin5 |
| BWU2617<br>BWU2684 | X1                | I1                                   | 24 V <sub>out</sub> of ASi | n.c. | 0 V <sub>out</sub> of ASi | I1   | n.c. |
|                    | X2                | I2                                   | 24 V <sub>out</sub> of ASi | n.c. | 0 V <sub>out</sub> of ASi | I2   | n.c. |
|                    | X3                | I3                                   | 24 V <sub>out</sub> of ASi | n.c. | 0 V <sub>out</sub> of ASi | I3   | n.c. |
|                    | X4                | I4                                   | 24 V <sub>out</sub> of ASi | n.c. | 0 V <sub>out</sub> of ASi | I4   | n.c. |
|                    | X5                | O1                                   | 0 V <sub>ext</sub> out     | n.c. | 0 V <sub>ext</sub> out    | O1   | n.c. |
|                    | X6                | O2                                   | 0 V <sub>ext</sub> out     | n.c. | 0 V <sub>ext</sub> out    | O2   | n.c. |
|                    | X7                | O3                                   | 0 V <sub>ext</sub> out     | n.c. | 0 V <sub>ext</sub> out    | O3   | n.c. |
|                    | X8                | O4                                   | 0 V <sub>ext</sub> out     | n.c. | 0 V <sub>ext</sub> out    | O4   | n.c. |
|                    | ADDR (dummy plug) | connection for ASi addressing device |                            |      |                           |      |      |
| BWU2619            | X1                | I1/I2                                | 24 V <sub>out</sub> of ASi | I2   | 0 V <sub>out</sub> of ASi | I1   | n.c. |
|                    | X2                | I3/I4                                | 24 V <sub>out</sub> of ASi | I4   | 0 V <sub>out</sub> of ASi | I3   | n.c. |
|                    | X3                | I5/I6                                | 24 V <sub>out</sub> of ASi | I6   | 0 V <sub>out</sub> of ASi | I5   | n.c. |
|                    | X4                | I7/I8                                | 24 V <sub>out</sub> of ASi | I8   | 0 V <sub>out</sub> of ASi | I7   | n.c. |
|                    | X5                | O1/O2                                | 0 V <sub>ext</sub> out     | O2   | 0 V <sub>ext</sub> out    | O1   | n.c. |
|                    | X6                | O3/O4                                | 0 V <sub>ext</sub> out     | O4   | 0 V <sub>ext</sub> out    | O3   | n.c. |
|                    | X7                | O5/O6                                | 0 V <sub>ext</sub> out     | O6   | 0 V <sub>ext</sub> out    | O5   | n.c. |
|                    | X8                | O7/O8                                | 0 V <sub>ext</sub> out     | O8   | 0 V <sub>ext</sub> out    | O7   | n.c. |
|                    | ADDR (dummy plug) | connection for ASi addressing device |                            |      |                           |      |      |
| BWU2626<br>BWU3426 | X1                | I1                                   | 24 V <sub>out</sub> of ASi | I2   | 0 V <sub>out</sub> of ASi | I1   | n.c. |
|                    | X2                | I2                                   | 24 V <sub>out</sub> of ASi | n.c. | 0 V <sub>out</sub> of ASi | I2   | n.c. |
|                    | X3                | I3                                   | 24 V <sub>out</sub> of ASi | I4   | 0 V <sub>out</sub> of ASi | I3   | n.c. |
|                    | X4                | I4                                   | 24 V <sub>out</sub> of ASi | n.c. | 0 V <sub>out</sub> of ASi | I4   | n.c. |
|                    | X5                | O1                                   | 0 V <sub>ext</sub> out     | O2   | 0 V <sub>ext</sub> out    | O1   | n.c. |
|                    | X6                | O2                                   | 0 V <sub>ext</sub> out     | n.c. | 0 V <sub>ext</sub> out    | O2   | n.c. |
|                    | X7                | O3                                   | 0 V <sub>ext</sub> out     | O4   | 0 V <sub>ext</sub> out    | O3   | n.c. |
|                    | X8                | O4                                   | 0 V <sub>ext</sub> out     | n.c. | 0 V <sub>ext</sub> out    | O4   | n.c. |
|                    | ADDR (dummy plug) | connection for ASi addressing device |                            |      |                           |      |      |
| BWU3496            | X1                | I1                                   | 24 V <sub>out</sub> of ASi | n.c. | 0 V <sub>out</sub> of ASi | I1   | n.c. |
|                    | X2                | I2                                   | 24 V <sub>out</sub> of ASi | n.c. | 0 V <sub>out</sub> of ASi | I2   | n.c. |
|                    | X3                | I3                                   | 24 V <sub>out</sub> of ASi | n.c. | 0 V <sub>out</sub> of ASi | I3   | n.c. |
|                    | X4                | I4                                   | 24 V <sub>out</sub> of ASi | n.c. | 0 V <sub>out</sub> of ASi | I4   | n.c. |
|                    | X5                | O1                                   | 0 V <sub>ext</sub> out     | n.c. | 0 V <sub>ext</sub> out    | O1   | n.c. |
|                    | X6                | O2                                   | 0 V <sub>ext</sub> out     | n.c. | 0 V <sub>ext</sub> out    | O2   | n.c. |
|                    | X7                | O3                                   | 0 V <sub>ext</sub> out     | n.c. | 0 V <sub>ext</sub> out    | O3   | n.c. |
|                    | X8                | not used                             |                            |      |                           |      |      |
|                    | ADDR (dummy plug) | connection for ASi addressing device |                            |      |                           |      |      |

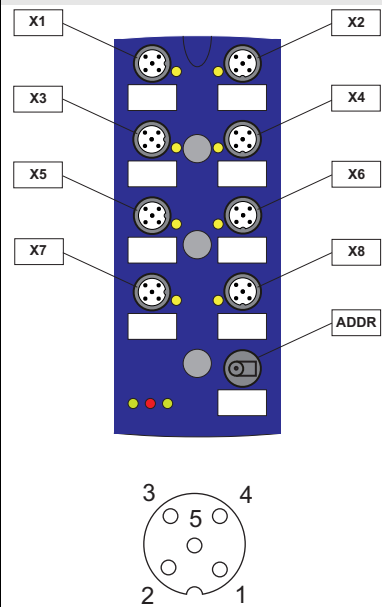

# Digital Modules ASi, IP67, M12



| Connections |                          |                                      |                            |      |                           |      |      |
|-------------|--------------------------|--------------------------------------|----------------------------|------|---------------------------|------|------|
| Article no. | M12 connection           | Marking                              | Pin1                       | Pin2 | Pin3                      | Pin4 | Pin5 |
| BWU3540     | X1                       | I1                                   | 24 V <sub>out of ASi</sub> | n.c. | 0 V <sub>out of ASi</sub> | I1   | n.c. |
|             | X2                       | I2                                   | 24 V <sub>out of ASi</sub> | n.c. | 0 V <sub>out of ASi</sub> | I2   | n.c. |
|             | X3                       | I3                                   | 24 V <sub>out of ASi</sub> | n.c. | 0 V <sub>out of ASi</sub> | I3   | n.c. |
|             | X4                       | I4                                   | 24 V <sub>out of ASi</sub> | n.c. | 0 V <sub>out of ASi</sub> | I4   | n.c. |
|             | X5                       | O1                                   | 0 V <sub>ext out</sub>     | n.c. | 0 V <sub>ext out</sub>    | O1   | n.c. |
|             | X6                       | O2                                   | 0 V <sub>ext out</sub>     | n.c. | 0 V <sub>ext out</sub>    | O2   | n.c. |
|             | X7                       | O3                                   | 0 V <sub>ext out</sub>     | n.c. | 0 V <sub>ext out</sub>    | O3   | n.c. |
|             | X8                       | O4                                   | 0 V <sub>ext out</sub>     | n.c. | 0 V <sub>ext out</sub>    | O4   | n.c. |
|             | <b>ADDR (dummy plug)</b> | connection for ASi addressing device |                            |      |                           |      |      |
| BWU3892     | X1                       | I1/I2                                | 24 V <sub>ext out</sub>    | I2   | 0 V <sub>ext out</sub>    | I1   | n.c. |
|             | X2                       | I3/I4                                | 24 V <sub>ext out</sub>    | I4   | 0 V <sub>ext out</sub>    | I3   | n.c. |
|             | X3                       | I5/I6                                | 24 V <sub>ext out</sub>    | I6   | 0 V <sub>ext out</sub>    | I5   | n.c. |
|             | X4                       | I7/I8                                | 24 V <sub>ext out</sub>    | I8   | 0 V <sub>ext out</sub>    | I7   | n.c. |
|             | X5                       | O1/O2                                | 0 V <sub>ext out</sub>     | O2   | 0 V <sub>ext out</sub>    | O1   | n.c. |
|             | X6                       | O3/O4                                | 0 V <sub>ext out</sub>     | O4   | 0 V <sub>ext out</sub>    | O3   | n.c. |
|             | X7                       | O5/O6                                | 0 V <sub>ext out</sub>     | O6   | 0 V <sub>ext out</sub>    | O5   | n.c. |
|             | X8                       | O7/O8                                | 0 V <sub>ext out</sub>     | O8   | 0 V <sub>ext out</sub>    | O7   | n.c. |
|             | <b>ADDR (dummy plug)</b> | connection for ASi addressing device |                            |      |                           |      |      |
| BWU2651     | X1                       | I1                                   | 24 V <sub>out of ASi</sub> | I2   | 0 V <sub>out of ASi</sub> | I1   | n.c. |
|             | X2                       | I2                                   | 24 V <sub>out of ASi</sub> | n.c. | 0 V <sub>out of ASi</sub> | I2   | n.c. |
|             | X3                       | I3                                   | 24 V <sub>out of ASi</sub> | I4   | 0 V <sub>out of ASi</sub> | I3   | n.c. |
|             | X4                       | I4                                   | 24 V <sub>out of ASi</sub> | n.c. | 0 V <sub>out of ASi</sub> | I4   | n.c. |
|             | X5                       | I5                                   | 24 V <sub>out of ASi</sub> | I6   | 0 V <sub>out of ASi</sub> | I5   | n.c. |
|             | X6                       | I6                                   | 24 V <sub>out of ASi</sub> | n.c. | 0 V <sub>out of ASi</sub> | I6   | n.c. |
|             | X7                       | I7                                   | 24 V <sub>out of ASi</sub> | I8   | 0 V <sub>out of ASi</sub> | I7   | n.c. |
|             | X8                       | I8                                   | 24 V <sub>out of ASi</sub> | n.c. | 0 V <sub>out of ASi</sub> | I8   | n.c. |
|             | <b>ADDR (dummy plug)</b> | connection for ASi addressing device |                            |      |                           |      |      |
| BWU2983     | X1                       | I1                                   | 24 V <sub>out of ASi</sub> | n.c. | 0 V <sub>out of ASi</sub> | I1   | n.c. |
|             | X2                       | I2                                   | 24 V <sub>out of ASi</sub> | n.c. | 0 V <sub>out of ASi</sub> | I2   | n.c. |
|             | X3                       | I3                                   | 24 V <sub>out of ASi</sub> | n.c. | 0 V <sub>out of ASi</sub> | I3   | n.c. |
|             | X4                       | I4                                   | 24 V <sub>out of ASi</sub> | n.c. | 0 V <sub>out of ASi</sub> | I4   | n.c. |
|             | X5                       | I5                                   | 24 V <sub>out of ASi</sub> | n.c. | 0 V <sub>out of ASi</sub> | I5   | n.c. |
|             | X6                       | I6                                   | 24 V <sub>out of ASi</sub> | n.c. | 0 V <sub>out of ASi</sub> | I6   | n.c. |
|             | X7                       | I7                                   | 24 V <sub>out of ASi</sub> | n.c. | 0 V <sub>out of ASi</sub> | I7   | n.c. |
|             | X8                       | I8                                   | 24 V <sub>out of ASi</sub> | n.c. | 0 V <sub>out of ASi</sub> | I8   | n.c. |
|             | <b>ADDR (dummy plug)</b> | connection for ASi addressing device |                            |      |                           |      |      |
| BWU2652     | X1                       | O1                                   | 0 V <sub>ext out</sub>     | O2   | 0 V <sub>ext out</sub>    | O1   | n.c. |
|             | X2                       | O2                                   | 0 V <sub>ext out</sub>     | n.c. | 0 V <sub>ext out</sub>    | O2   | n.c. |
|             | X3                       | O3                                   | 0 V <sub>ext out</sub>     | O4   | 0 V <sub>ext out</sub>    | O3   | n.c. |
|             | X4                       | O4                                   | 0 V <sub>ext out</sub>     | n.c. | 0 V <sub>ext out</sub>    | O4   | n.c. |
|             | X5                       | O5                                   | 0 V <sub>ext out</sub>     | O6   | 0 V <sub>ext out</sub>    | O5   | n.c. |
|             | X6                       | O6                                   | 0 V <sub>ext out</sub>     | n.c. | 0 V <sub>ext out</sub>    | O6   | n.c. |
|             | X7                       | O7                                   | 0 V <sub>ext out</sub>     | O8   | 0 V <sub>ext out</sub>    | O7   | n.c. |
|             | X8                       | O8                                   | 0 V <sub>ext out</sub>     | n.c. | 0 V <sub>ext out</sub>    | O8   | n.c. |
|             | <b>ADDR (dummy plug)</b> | connection for ASi addressing device |                            |      |                           |      |      |
| BWU2770     | X1                       | I1                                   | 24 V <sub>ext out</sub>    | I2   | 0 V <sub>ext out</sub>    | I1   | n.c. |
|             | X2                       | I2                                   | 24 V <sub>ext out</sub>    | n.c. | 0 V <sub>ext out</sub>    | I2   | n.c. |
|             | X3                       | I3                                   | 24 V <sub>ext out</sub>    | I4   | 0 V <sub>ext out</sub>    | I3   | n.c. |
|             | X4                       | I4                                   | 24 V <sub>ext out</sub>    | n.c. | 0 V <sub>ext out</sub>    | I4   | n.c. |
|             | X5                       | I5                                   | 24 V <sub>ext out</sub>    | I6   | 0 V <sub>ext out</sub>    | I5   | n.c. |
|             | X6                       | I6                                   | 24 V <sub>ext out</sub>    | n.c. | 0 V <sub>ext out</sub>    | I6   | n.c. |
|             | X7                       | I7                                   | 24 V <sub>ext out</sub>    | I8   | 0 V <sub>ext out</sub>    | I7   | n.c. |
|             | X8                       | I8                                   | 24 V <sub>ext out</sub>    | n.c. | 0 V <sub>ext out</sub>    | I8   | n.c. |
|             | <b>ADDR (dummy plug)</b> | connection for ASi addressing device |                            |      |                           |      |      |

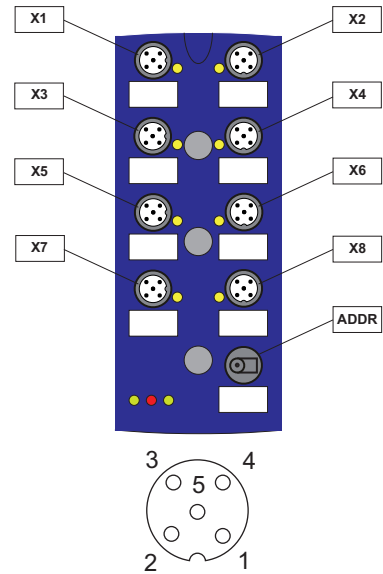

# Digital Modules ASi, IP67, M12



| Connections |                          |                                      |                         |      |                        |      |      |
|-------------|--------------------------|--------------------------------------|-------------------------|------|------------------------|------|------|
| Article no. | M12 connection           | Marking                              | Pin1                    | Pin2 | Pin3                   | Pin4 | Pin5 |
| BWU2810     | X1                       | I1                                   | 24 V <sub>ext out</sub> | n.c. | 0 V <sub>ext out</sub> | I1   | n.c. |
|             | X2                       | I2                                   | 24 V <sub>ext out</sub> | n.c. | 0 V <sub>ext out</sub> | I2   | n.c. |
|             | X3                       | I3                                   | 24 V <sub>ext out</sub> | n.c. | 0 V <sub>ext out</sub> | I3   | n.c. |
|             | X4                       | I4                                   | 24 V <sub>ext out</sub> | n.c. | 0 V <sub>ext out</sub> | I4   | n.c. |
|             | X5                       | O1                                   | 0 V <sub>ext out</sub>  | n.c. | 0 V <sub>ext out</sub> | O1   | n.c. |
|             | X6                       | O2                                   | 0 V <sub>ext out</sub>  | n.c. | 0 V <sub>ext out</sub> | O2   | n.c. |
|             | X7                       | O3                                   | 0 V <sub>ext out</sub>  | n.c. | 0 V <sub>ext out</sub> | O3   | n.c. |
|             | X8                       | O4                                   | 0 V <sub>ext out</sub>  | n.c. | 0 V <sub>ext out</sub> | O4   | n.c. |
|             | <b>ADDR (dummy plug)</b> | connection for ASi addressing device |                         |      |                        |      |      |
| BWU3510     | X1                       | I1                                   | 24 V <sub>ext out</sub> | I2   | 0 V <sub>ext out</sub> | I1   | n.c. |
|             | X2                       | I2                                   | 24 V <sub>ext out</sub> | n.c. | 0 V <sub>ext out</sub> | I2   | n.c. |
|             | X3                       | I3                                   | 24 V <sub>ext out</sub> | I4   | 0 V <sub>ext out</sub> | I3   | n.c. |
|             | X4                       | I4                                   | 24 V <sub>ext out</sub> | n.c. | 0 V <sub>ext out</sub> | I4   | n.c. |
|             | X5                       | O1                                   | n.c.                    | O2   | 0 V <sub>ext out</sub> | O1   | n.c. |
|             | X6                       | O2                                   | n.c.                    | n.c. | 0 V <sub>ext out</sub> | O2   | n.c. |
|             | X7                       | O3                                   | n.c.                    | O4   | 0 V <sub>ext out</sub> | O3   | n.c. |
|             | X8                       | O4                                   | n.c.                    | n.c. | 0 V <sub>ext out</sub> | O4   | n.c. |
|             | <b>ADDR (dummy plug)</b> | connection for ASi addressing device |                         |      |                        |      |      |

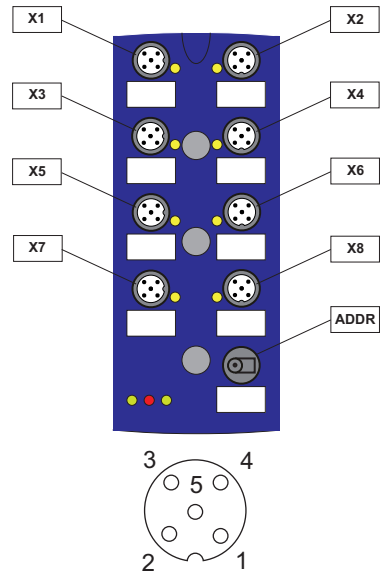

# Digital Modules ASi, IP67, M12



| Connections |                |         |                         |                       |                        |                        |      |
|-------------|----------------|---------|-------------------------|-----------------------|------------------------|------------------------|------|
| Article no. | M12 connection | Marking | Pin1                    | Pin2                  | Pin3                   | Pin4                   | Pin5 |
| BWU2645     | X1             | I1      | 24 V <sub>ext out</sub> | n.c.                  | 0 V <sub>ext out</sub> | I1                     | n.c. |
|             | X2             | I2      | 24 V <sub>ext out</sub> | n.c.                  | 0 V <sub>ext out</sub> | I2                     | n.c. |
|             | X3             | I3      | 24 V <sub>ext out</sub> | n.c.                  | 0 V <sub>ext out</sub> | I3                     | n.c. |
|             | X4             | I4      | 24 V <sub>ext out</sub> | n.c.                  | 0 V <sub>ext out</sub> | I4                     | n.c. |
|             | X5             | O1      | 0 V <sub>ext out</sub>  | n.c.                  | 0 V <sub>ext out</sub> | O1                     | n.c. |
|             | X6             | O2      | 0 V <sub>ext out</sub>  | n.c.                  | 0 V <sub>ext out</sub> | O2                     | n.c. |
|             | X7             | O3      | 0 V <sub>ext out</sub>  | n.c.                  | 0 V <sub>ext out</sub> | O3                     | n.c. |
|             | X8             | O4      | 0 V <sub>ext out</sub>  | n.c.                  | 0 V <sub>ext out</sub> | O4                     | n.c. |
|             | X9             | ASi     | ASi+                    | 0 V <sub>ext in</sub> | ASi-                   | 24 V <sub>ext in</sub> | -    |

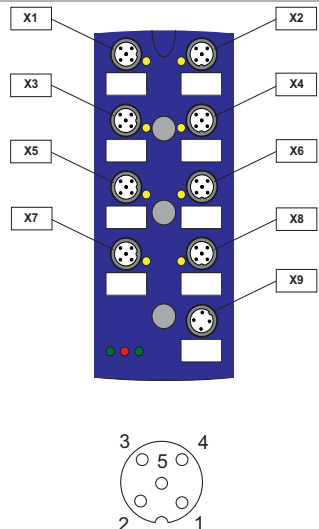

## Mounting according to cable direction

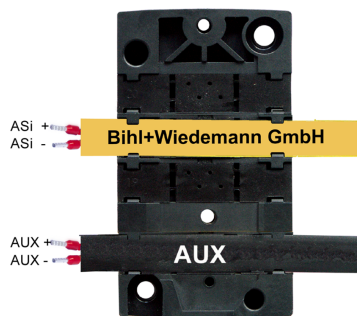

ordinary

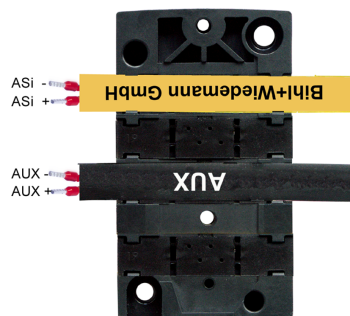

turned

## Line termination with sealing profiles / as junction

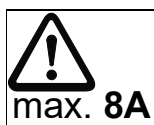
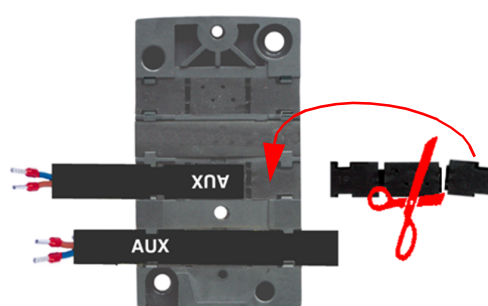
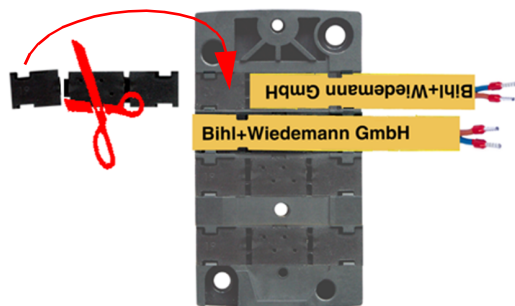

## Accessories:

- ASi substructure module for 4 channel module in 45 mm housing (art. no. BWU2349)
- ASi substructure module (CNOMO) for 4 channel module in 45 mm housing (art. no. BWU2350)
- ASi substructure module (CNOMO) for 8 channel module in 60 mm housing (art. no. BWU2351)
- Protection caps for unused M12 sockets (art. no. BW2368)
- Sealing profile IP67 (IDC plug), 60 mm (art. no. BW3282)
- Sealing profile IP67 (IDC plug), 45 mm (art. no. BW3283)
- Passive Distributor ASi/AUX to 2 x M12 socket, internal protection via changeable 4 A slow-blow fuses (art. no. BWU3087)
- It is recommended to use pre-assembled cables to connect the power source with the module.



# SCATTERGOOD & JOHNSON LTD

ELECTRICAL ENGINEERING & FLUID CONTROL DISTRIBUTORS

Est.1899

At Scattergood & Johnson Ltd, we pride ourselves on being a technical distributor to specialist industries.

Working with a range of quality product suppliers across a number of specialist markets, we are not your average 'box shifter' - we are your technical and supply chain partner.

We fully support every product we sell - for free! Our internal team and external sales engineers can answer any product or application question, no matter the complexity.

Backing up this technical ability is a range of 50,000+ products available from stock for nationwide next day delivery (same day if required!), or you can collect what you need from any of our trade counters around the UK.

Select your specialist interest below to learn more about how we can help.

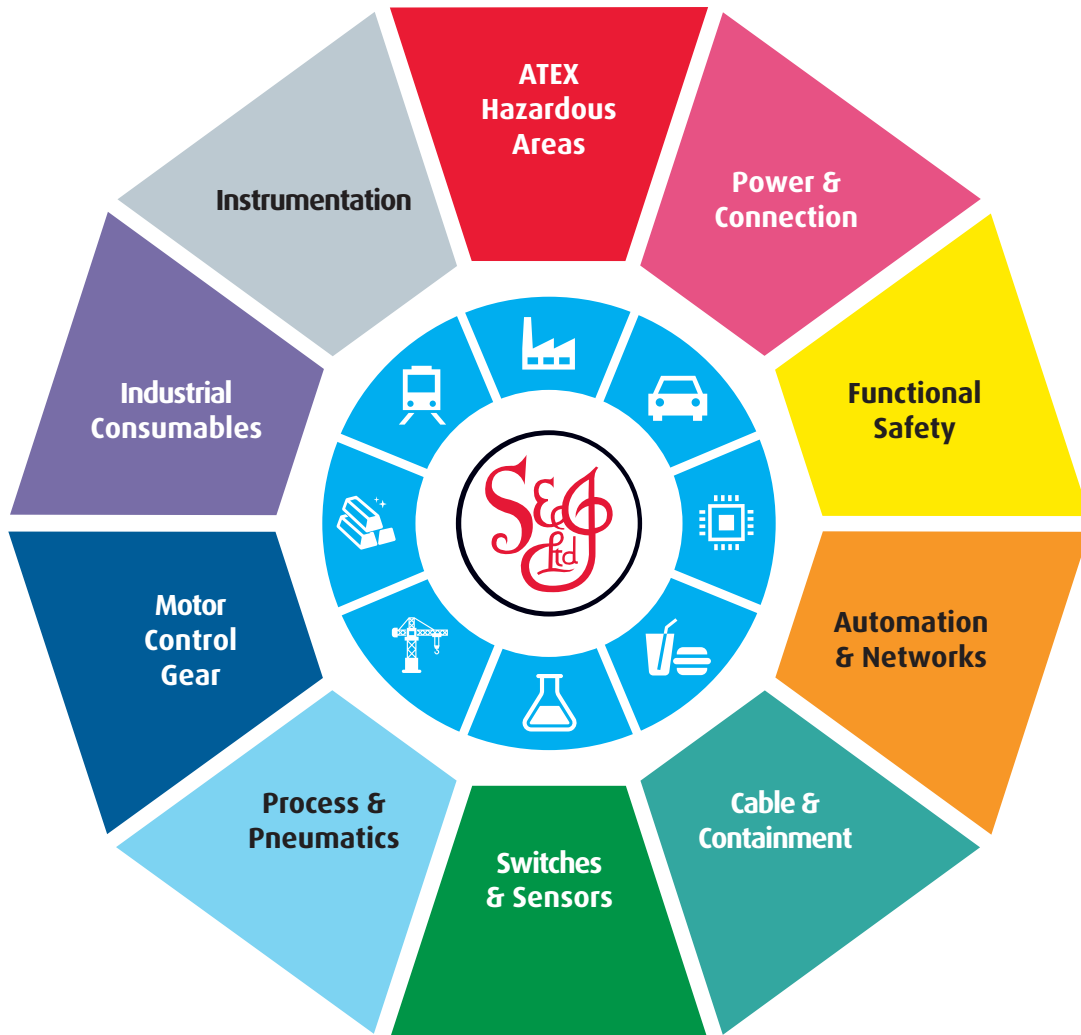

Online, In Branch and On the Road - Scattergood & Johnson Ltd, there when you need us.

# [www.scatts.co.uk](http://www.scatts.co.uk)