

BI10U-M30-AD4X

Inductive sensor

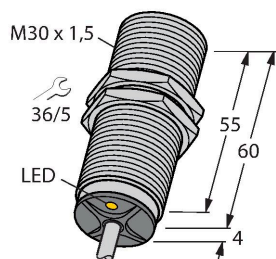

Features

- M30 x 1.5 threaded tube
- Chrome-plated brass
- Factor 1 for all metals
- Resistant to magnetic fields
- DC 2-wire, 10...65 VDC
- NO contact
- Cable connection

Wiring diagram

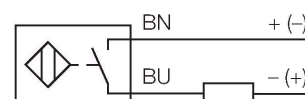

Technical data

Type	BI10U-M30-AD4X
Ident. no.	4405073
Rated switching distance	10 mm
Mounting conditions	Flush
Secured operating distance	$\leq (0.81 \times S_n)$ mm
Repeat accuracy	$\leq 2\%$ of full scale
Temperature drift	$\leq \pm 10\%$ $\leq \pm 15\%, \leq -25\text{ °C } v \geq +70\text{ °C}$
Hysteresis	3...20 %
Ambient temperature	-25...+70 °C
Operating voltage	10...65 VDC
Residual ripple	$\leq 10\% U_{ss}$
DC rated operational current	$\leq 100\text{ mA}$
Residual current	$\leq 0.8\text{ mA}$
Isolation test voltage	$\leq 0.5\text{ kV}$
Short-circuit protection	yes / Cyclic
Voltage drop at I_e	$\leq 5\text{ V}$
Wire breakage/Reverse polarity protection	Complete
Output function	2-wire, NO contact, 2-wire
Smallest operating current	$\geq 3\text{ mA}$
Switching frequency	0.01 kHz
Design	Threaded barrel, M30 x 1.5
Dimensions	64 mm
Housing material	Metal, CuZn, Chrome-plated
Active area material	Plastic, LCP
End cap	Plastic, EPTR
Max. tightening torque housing nut	75 Nm

Functional principle

Inductive sensors detect metal objects contactless and wear-free. Due to the patented multi-coil system, *uproX*[®] sensors have distinct advantages compared to conventional sensors. They excel in largest switching distances, maximum flexibility and operational reliability as well as efficient standardization.

Technical data

Electrical connection	Cable
Cable quality	Ø 5.2 mm, LifYY, PVC, 2 m
Core cross-section	2 x 0.34 mm ²
Vibration resistance	55 Hz (1 mm)
Shock resistance	30 g (11 ms)
Protection class	IP68
MTTF	874 years acc. to SN 29500 (Ed. 99) 40 °C
Switching state	LED, Yellow

Mounting instructions

Mounting instructions/Description

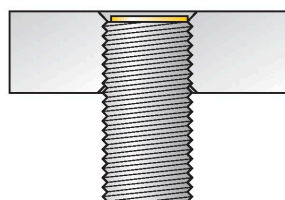
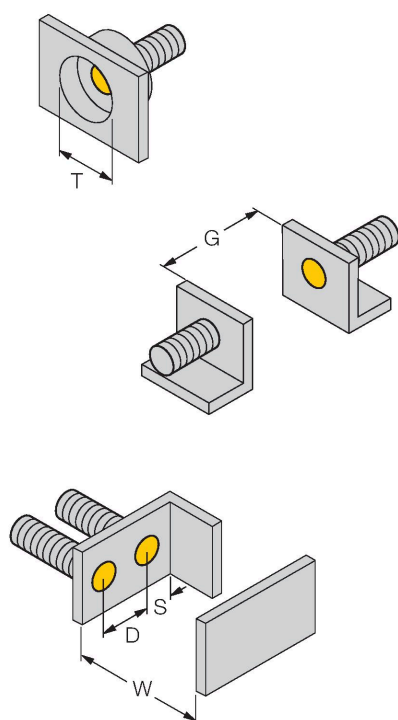

Distance D	60 mm
Distance W	3 x Sn
Distance T	3 x B
Distance S	1.5 x B
Distance G	6 x Sn
Diameter active area B	Ø 30 mm

All flush mountable *uprox*[®]+ threaded barrel types are also recessed mountable. Safe operation is ensured if the sensor is screwed in by half a turn.

The use of isolating switching amplifiers is possible, because *uprox*[®]+ 2-wire DC sensors operate with 8 VDC low voltage (limited load current 50mA).

The sensors can be operated with the Turck remote I/O fieldbus system BL20. If the sensors are combined with a BL20-4DI-NAMUR slice, events of wire-break or short-circuit can be detected immediately.

Accessories

BST-30B

6947216

Mounting clamp for threaded barrel sensors, with dead-stop; material: PA6

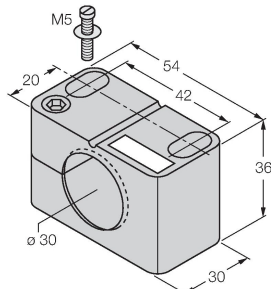

QM-30

6945103

Quick-mount bracket with dead-stop; material: Chrome-plated brass. Male thread M36 x 1.5. Note: The switching distance of the proximity switches may change when using quick-mount brackets.

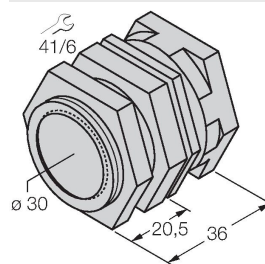

MW30

6945005

Mounting bracket for threaded barrel sensors; material: Stainless steel A2 1.4301 (AISI 304)

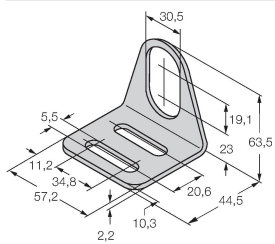

BSS-30

6901319

Mounting clamp for smooth and threaded barrel sensors; material: Polypropylene

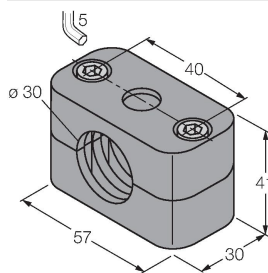

BL20-4DI-NAMUR

6827212

4 digital inputs acc. to EN 60947-5-6 For NAMUR sensors, de-energized contacts or uprox®+ 2-wire DC sensors.

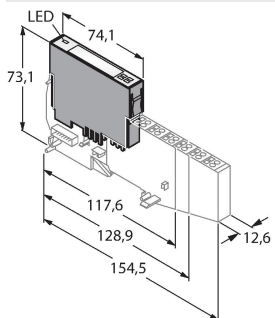



SCATTERGOOD & JOHNSON LTD

ELECTRICAL ENGINEERING & FLUID CONTROL DISTRIBUTORS

Est.1899

At Scattergood & Johnson Ltd, we pride ourselves on being a technical distributor to specialist industries.

Working with a range of quality product suppliers across a number of specialist markets, we are not your average 'box shifter' - we are your technical and supply chain partner.

We fully support every product we sell - for free! Our internal team and external sales engineers can answer any product or application question, no matter the complexity.

Backing up this technical ability is a range of 50,000+ products available from stock for nationwide next day delivery (same day if required!), or you can collect what you need from any of our trade counters around the UK.

Select your specialist interest below to learn more about how we can help.



Online, In Branch and On the Road - Scattergood & Johnson Ltd, there when you need us.

www.scatts.co.uk