



# LMS111-10100

LMS1xx

2D LIDAR SENSORS

**SICK**  
Sensor Intelligence.



### Ordering information

Type	Part no.
LMS111-10100	1041114

Other models and accessories → [www.sick.com/LMS1xx](http://www.sick.com/LMS1xx)



### Detailed technical data

#### Features

<b>Application</b>	Outdoor
<b>Light source</b>	Infrared (905 nm)
<b>Laser class</b>	1 (IEC 60825-1:2014, EN 60825-1:2014)
<b>Aperture angle</b>	Horizontal 270°
<b>Scanning frequency</b>	25 Hz 50 Hz
<b>Angular resolution</b>	0.25° 0.5°
<b>Heating</b>	Yes
<b>Working range</b>	0.5 m ... 20 m
<b>Scanning range</b>	At 10% remission 18 m At 90% remission 20 m
<b>Amount of evaluated echoes</b>	2
<b>Fog correction</b>	Yes

#### Mechanics/electronics

<b>Connection type</b>	1 x M12 round connector
<b>Supply voltage</b>	10.8 V DC ... 30 V DC
<b>Power consumption</b>	Typ. 8 W, heating typ. 35 W
<b>Housing color</b>	Gray (RAL 7032)
<b>Enclosure rating</b>	IP67 (EN 60529, Section 14.2.7)
<b>Protection class</b>	III (EN 50178 (1997;10))
<b>Weight</b>	1.1 kg
<b>Dimensions (L x W x H)</b>	105 mm x 102 mm x 162 mm

## Performance

<b>Response time</b>	≥ 20 ms
<b>Detectable object shape</b>	Almost any
<b>Systematic error</b>	± 30 mm <sup>1)</sup>
<b>Statistical error</b>	12 mm <sup>1)</sup>
<b>Integrated application</b>	Field evaluation with flexible fields
<b>Number of field sets</b>	10 fields
<b>Simultaneous evaluation cases</b>	10

<sup>1)</sup> Typical value; actual value depends on environmental conditions.

## Interfaces

<b>Ethernet</b>	✓, TCP/IP
Remark	OPC DA
Function	Host
Data transmission rate	10/100 MBit/s
<b>Serial</b>	✓, RS-232
Function	Host, AUX
Data transmission rate	9.6 kBaud ... 115.2 kBaud
<b>CAN</b>	✓
Function	Extension of outputs
<b>Digital inputs</b>	2 digital and 2 encoder inputs
<b>Digital outputs</b>	3
<b>Optical indicators</b>	7-segment display (plus 5 LEDs showing device status, contamination warning and initial condition)

## Ambient data

<b>Object remission</b>	2 % ... > 1,000 % (reflectors)
<b>Electromagnetic compatibility (EMC)</b>	EN 61000-6-2:2005 / EN 61000-6-3:2007+A1:2011
<b>Vibration resistance</b>	EN 60068-2-6 (1995-04)
<b>Shock resistance</b>	EN 60068-2-27 (1993-03)
<b>Ambient operating temperature</b>	-30 °C ... +50 °C
<b>Storage temperature</b>	-30 °C ... +70 °C
<b>Ambient light immunity</b>	40,000 lx

## General notes

<b>Note on use</b>	The sensor does not constitute a safety component as defined by relevant legislation on machine safety.
--------------------	---

## Classifications

<b>ECl@ss 5.0</b>	27270990
<b>ECl@ss 5.1.4</b>	27270990
<b>ECl@ss 6.0</b>	27270913
<b>ECl@ss 6.2</b>	27270913
<b>ECl@ss 7.0</b>	27270913
<b>ECl@ss 8.0</b>	27270913

<b>ECl@ss 8.1</b>	27270913
<b>ECl@ss 9.0</b>	27270913
<b>ECl@ss 10.0</b>	27270913
<b>ECl@ss 11.0</b>	27270913
<b>ETIM 5.0</b>	EC002550
<b>ETIM 6.0</b>	EC002550
<b>ETIM 7.0</b>	EC002550
<b>ETIM 8.0</b>	EC002550
<b>UNSPSC 16.0901</b>	46171620

### Dimensional drawing (Dimensions in mm (inch))

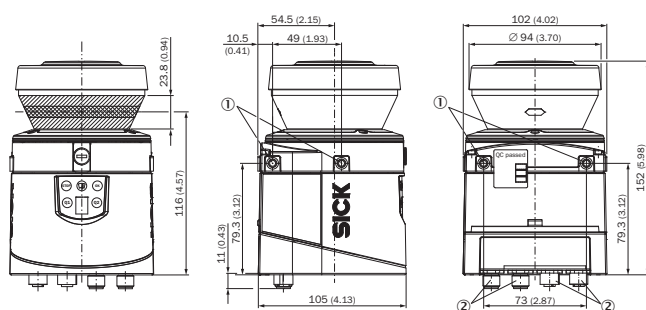

- ① Mounting hole M5 x 7.5
- ② Connector M12

### Working range diagram

Scanning range in m (ft)

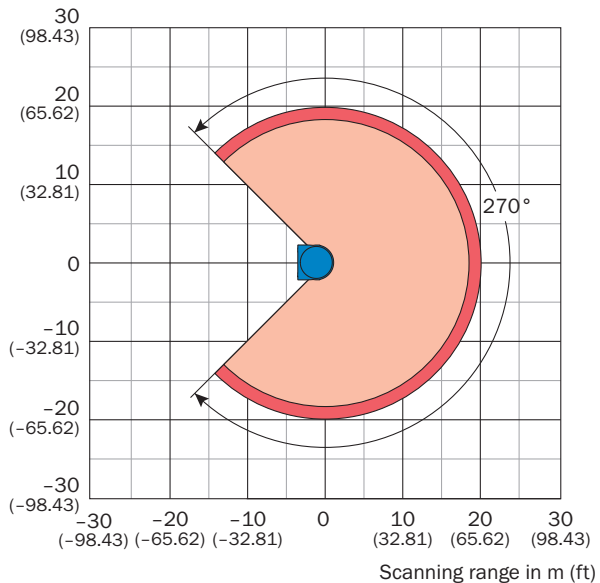

- Scanning range max. 20 m (65.62 ft)
- Scanning range for objects up to 10 % remission 18 m (59.06 ft)

## PIN assignment

### Power

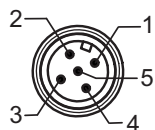

Connector M12, 5-pin, A-coded

- ① V<sub>s</sub>
- ② V<sub>s</sub> Heat.
- ③ GND
- ④ Reserved
- ⑤ GND heat.

### AUX















Female connector M8, 4-pin

- ① Reserved
- ② RxD AUX
- ③ GND RS
- ④ TxD AUX

## Recommended accessories

Other models and accessories → [www.sick.com/LMS1xx](http://www.sick.com/LMS1xx)

	Brief description	Type	Part no.
Device protection (mechanical)			
	<ul style="list-style-type: none"> <li><b>Description:</b> Weather hood, 190°</li> </ul>	Weather protection cover 190°	2046459
	<ul style="list-style-type: none"> <li><b>Description:</b> Weather hood, 270°</li> </ul>	Weather protection cover 270°	2046458
Mounting brackets and plates			
	<ul style="list-style-type: none"> <li><b>Description:</b> Standard mounting set for weather hood</li> </ul>	Mounting bracket	2046025
	<ul style="list-style-type: none"> <li><b>Description:</b> Mounting bracket for rear mounting on wall or machine</li> <li><b>Packing unit:</b> 1 piece</li> </ul>	Mounting kit 1a	2034324
	<ul style="list-style-type: none"> <li><b>Description:</b> Mounting bracket for rear mounting on wall or machine with protection of optics hood</li> <li><b>Packing unit:</b> 1 piece</li> </ul>	Mounting kit 1b	2034325
	<ul style="list-style-type: none"> <li><b>Description:</b> Mounting bracket, adjustable lateral axis, only in conjunction with mounting kit 1a (2034324) or 1b (2034325)</li> <li><b>Packing unit:</b> 1 piece</li> </ul>	Mounting kit 2	2039302
	<ul style="list-style-type: none"> <li><b>Description:</b> Mounting plate, adjustable longitudinal axis, only in conjunction with mounting kit 2 (2039302)</li> <li><b>Packing unit:</b> 1 piece</li> </ul>	Mounting kit 3	2039303

	Brief description	Type	Part no.
Plug connectors and cables			
	<ul style="list-style-type: none"> <li>• <b>Connection type head A:</b> Female connector, M12, 8-pin, straight, A-coded</li> <li>• <b>Connection type head B:</b> Flying leads</li> <li>• <b>Signal type:</b> RS-232, RS-422</li> <li>• <b>Cable:</b> 5 m, 8-wire</li> <li>• <b>Description:</b> RS-232, shielded, RS-422</li> <li>• <b>Connection systems:</b> Flying leads</li> </ul>	Connecting cable (female connector - open)	6036153
	<ul style="list-style-type: none"> <li>• <b>Connection type head A:</b> Female connector, M12, 5-pin, straight, A-coded</li> <li>• <b>Connection type head B:</b> Flying leads</li> <li>• <b>Signal type:</b> Power</li> <li>• <b>Cable:</b> 5 m, 4-wire, PUR, halogen-free</li> <li>• <b>Description:</b> Power, shielded</li> <li>• <b>Connection systems:</b> Flying leads</li> </ul>	YF2A64-050XXXLEAX	6036159
	<ul style="list-style-type: none"> <li>• <b>Connection type head A:</b> Male connector, M12, 8-pin, straight, A-coded</li> <li>• <b>Connection type head B:</b> Flying leads</li> <li>• <b>Signal type:</b> Sensor/actuator cable</li> <li>• <b>Cable:</b> 5 m, 8-wire, PUR, halogen-free</li> <li>• <b>Description:</b> Sensor/actuator cable, shielded</li> <li>• <b>Connection systems:</b> Flying leads</li> <li>• <b>Application:</b> Zones with oils and lubricants, Drag chain operation</li> </ul>	YM2A28-050UA6XLEAX	6036155
	<ul style="list-style-type: none"> <li>• <b>Connection type head A:</b> Male connector, M12, 4-pin, straight, D-coded</li> <li>• <b>Connection type head B:</b> Male connector, RJ45, 4-pin, straight</li> <li>• <b>Authorizations:</b> CE, UL</li> <li>• <b>Signal type:</b> Ethernet, PROFINET</li> <li>• <b>Cable:</b> 5 m, 4-wire, PUR, halogen-free</li> <li>• <b>Description:</b> Ethernet, shielded, PROFINET</li> <li>• <b>Application:</b> Drag chain operation, Zones with oils and lubricants</li> </ul>	YM2D24-050PN1MRJA4	2106184
Terminal and alignment brackets			
	<ul style="list-style-type: none"> <li>• <b>Description:</b> Quick-action lock system for weather hood 190°/270°</li> </ul>	Quick release	2046989

Recommended services

Additional services → [www.sick.com/LMS1xx](http://www.sick.com/LMS1xx)

	Type	Part no.
Product, system, and software training		
<ul style="list-style-type: none"> <li>• <b>Range of services:</b> The training contents relate to the following 2D and 3D LiDAR sensors: LMS series, MRS1000, MRS6000, NAV series or TiM series, Training format and location can be worked out in collaboration with SICK</li> </ul>	Training LMS/MRS/NAV/TiM	1612234
Commissioning		
<ul style="list-style-type: none"> <li>• <b>Product area:</b> 2D LiDAR sensors, 3D LiDAR sensors</li> <li>• <b>Range of services:</b> Inspection of connection, fine adjustment, configuration of monitored areas, configuration and optimization of parameters of the LMS/MRS/NAV/TiM as well as tests, Setup of previously defined functions of basic settings, parameters of field application, filters for raw data output and product-specific configuration</li> <li>• <b>Travel expenses:</b> The prices do not include travel costs such as hotel, flight, travel time and expenses.</li> <li>• <b>Duration:</b> Additional work will be invoiced separately</li> </ul>	Commissioning LMS/MRS/NAV/TiM/People Counter (Prime package)	1680672

	Type	Part no.
Maintenance		
<ul style="list-style-type: none"> <li>• <b>Product area:</b> 2D LiDAR sensors, 3D LiDAR sensors</li> <li>• <b>Range of services:</b> Inspection, analysis and restoring of defined functions, Inspection and adaptation of basic settings, parameters of field application, filters for raw data output, and product-specific configuration</li> <li>• <b>Travel expenses:</b> The prices do not include travel costs such as hotel, flight, travel time and expenses.</li> <li>• <b>Duration:</b> Additional work will be invoiced separately</li> </ul>	Maintenance LMS/ MRS/NAV/TiM	1682593
Warranty extensions		
<ul style="list-style-type: none"> <li>• <b>Product area:</b> Identification solutions, machine vision, Distance sensors, Detection and ranging solutions</li> <li>• <b>Range of services:</b> The services correspond to the scope of the statutory manufacturer warranty (SICK general terms and conditions of purchase)</li> <li>• <b>Duration:</b> Five-year warranty from delivery date.</li> </ul>	Extended warranty for a total of five years from delivery date	1680671

## SICK AT A GLANCE

SICK is one of the leading manufacturers of intelligent sensors and sensor solutions for industrial applications. A unique range of products and services creates the perfect basis for controlling processes securely and efficiently, protecting individuals from accidents and preventing damage to the environment.

We have extensive experience in a wide range of industries and understand their processes and requirements. With intelligent sensors, we can deliver exactly what our customers need. In application centers in Europe, Asia and North America, system solutions are tested and optimized in accordance with customer specifications. All this makes us a reliable supplier and development partner.

Comprehensive services complete our offering: SICK LifeTime Services provide support throughout the machine life cycle and ensure safety and productivity.

For us, that is “Sensor Intelligence.”

## WORLDWIDE PRESENCE:

Contacts and other locations –[www.sick.com](http://www.sick.com)