



AFM60A-BBIB018x12

AFS/AFM60 EtherNet/IP

ABSOLUTE ENCODERS

SICK
Sensor Intelligence.

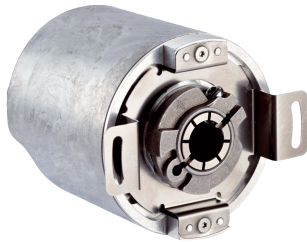

Illustration may differ



Ordering information

Type	Part no.
AFM60A-BBIB018x12	1077495

Other models and accessories → www.sick.com/AFS_AFM60_EtherNet_IP

Detailed technical data

Performance

Max. resolution (number of steps per revolution x number of revolutions)	18 bit x 12 bit (262,144 x 4,096)
Error limits G	0.03° ¹⁾
Repeatability standard deviation σ_r	0.002° ²⁾

¹⁾ In accordance with DIN ISO 1319-1, position of the upper and lower error limit depends on the installation situation, specified value refers to a symmetrical position, i.e. deviation in upper and lower direction is the same.

²⁾ In accordance with DIN ISO 55350-13; 68.3% of the measured values are inside the specified area.

Interfaces

Communication interface	EtherNet/IP™
Encoder profile	0 x 22
Data transmission rate (baud rate)	10 Mbit/s 100 Mbit/s
Transmission medium	CAT-5e cable
Parameterising data	Number of steps per revolution, number of revolutions, PRESET, counting direction, sampling rate for speed monitoring, unit for outputting the speed, acceleration, and temperature, output of scaleable limit values such as: position ranges, speed, acceleration, number of movements cw/ccw, direction changes, operating hours for power-on/motion, round axis functionality (only multiturn version), heartbeat
RPI (requested packet interval)	2 ms ... 750 ms
DLR (Device Level Ring)	✓
Available diagnostics data	Current, minimum and maximum temperature, maximum speed, power-on counter, operating hours counter for power-on/motion, counter of direction changes/number of movements cw/number of movements ccw, minimum and maximum operating voltage, signal monitoring for single and multiturn
Initialization time	6 s

Electrical data

Connection type	Male connector, 1x, M12, 4-pin, axial Female connector, 2x, M12, 4-pin, axial
Supply voltage	10 ... 30 V DC
Reverse polarity protection	✓

¹⁾ This product is a standard product and does not constitute a safety component as defined in the Machinery Directive. Calculation based on nominal load of components, average ambient temperature 40°C, frequency of use 8760 h/a. All electronic failures are considered hazardous. For more information, see document no. 8015532.

MTTFd: mean time to dangerous failure	80 years (EN ISO 13849-1) ¹⁾
--	---

¹⁾ This product is a standard product and does not constitute a safety component as defined in the Machinery Directive. Calculation based on nominal load of components, average ambient temperature 40 °C, frequency of use 8760 h/a. All electronic failures are considered hazardous. For more information, see document no. 8015532.

Mechanical data

Mechanical design	Blind hollow shaft
Shaft diameter	8 mm
Weight	0.2 kg
Shaft material	Stainless steel
Flange material	Aluminum
Housing material	Aluminum
Start up torque	0.8 Ncm, +20 °C
Operating torque	0.6 Ncm, +20 °C
Permissible shaft movement, axial static/dynamic	± 0.5 mm, ± 0.01 mm
Permissible shaft movement, radial static/dynamic	± 0.3 mm, ± 0.05 mm
Moment of inertia of the rotor	40 gcm ²
Bearing lifetime	3.0 x 10 ⁹ revolutions
Angular acceleration	≤ 500,000 rad/s ²
Operating speed	≤ 6,000 min ⁻¹ ¹⁾

¹⁾ Allow for self-heating of 3.3 K per 1,000 rpm when designing the operating temperature range.

Ambient data

EMC	According to EN 61000-6-2 and EN 61000-6-3 ¹⁾
Enclosure rating	IP65, shaft side (according to IEC 60529) IP67, housing side (according to IEC 60529) ²⁾
Permissible relative humidity	90 % (condensation of the optical scanning not permitted)
Operating temperature range	-40 °C ... +85 °C
Storage temperature range	-40 °C ... +100 °C, without package
Resistance to shocks	100 g, 6 ms (according to EN 60068-2-27)
Resistance to vibration	30 g, 10 Hz ... 2,000 Hz (according to EN 60068-2-6)

¹⁾ EMC according to the standards quoted is achieved if shielded cables are used.

²⁾ With mating connector fitted.

Classifications

ECl@ss 5.0	27270502
ECl@ss 5.1.4	27270502
ECl@ss 6.0	27270590
ECl@ss 6.2	27270590
ECl@ss 7.0	27270502
ECl@ss 8.0	27270502
ECl@ss 8.1	27270502
ECl@ss 9.0	27270502

ECI@ss 10.0	27270502
ECI@ss 11.0	27270502
ETIM 5.0	EC001486
ETIM 6.0	EC001486
ETIM 7.0	EC001486
ETIM 8.0	EC001486
UNSPSC 16.0901	41112113

Dimensional drawing (Dimensions in mm (inch))

Diameter x f7 corresponds to the shaft diameter

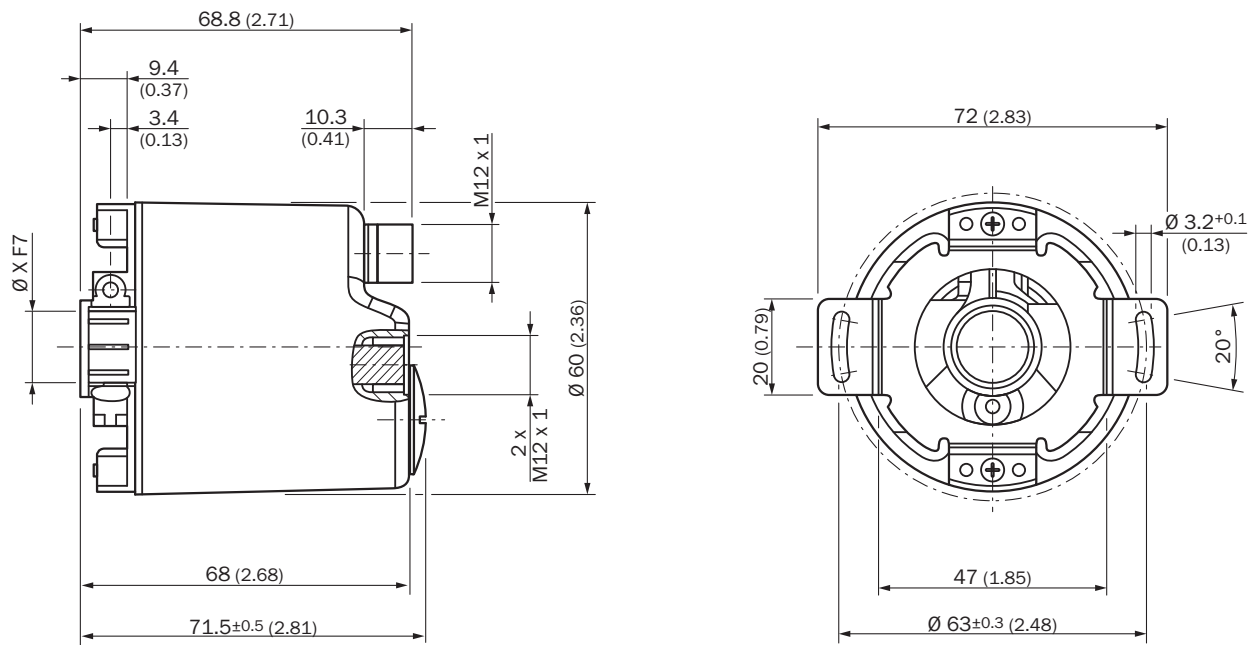

Attachment specifications

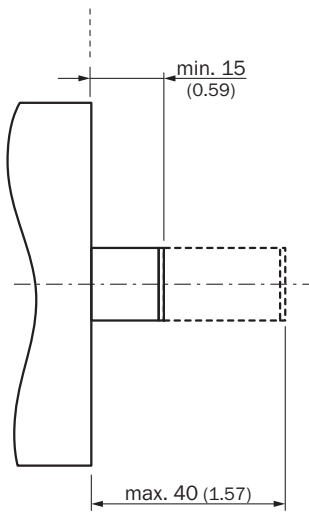

All dimensions in mm (inch)

PIN assignment

M12 - 4 x D coding



Port 1				
Signal	T x D+	R x D+	T x D-	R x D-
Pin	1	2	3	4

Port 2				
Signal	T x D+	R x D+	T x D-	R x D-
Pin	1	2	3	4

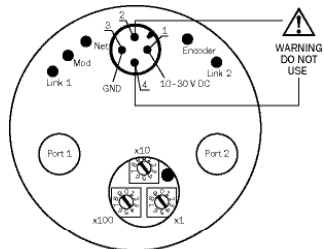

M12 - 4 x A coding













Power supply				
Signal	10 ... 30 V	Not connected	GND	Not connected
Pin	1	2	3	4

Recommended accessories

Other models and accessories → www.sick.com/AFS_AFM60_EtherNet_IP

	Brief description	Type	Part no.
Flanges	One-sided stator coupling, slot, slot radius 33 mm to 211.9 mm, slot width 5.1 mm	BEF-DS03DFS/VFS	2047431

	Brief description	Type	Part no.
Plug connectors and cables			
	Head A: male connector, M12, 4-pin, straight, D-coded Head B: Flying leads Cable: Ethernet, PUR, halogen-free, shielded, 2 m	STL-1204-G02ME90	6045284
	Head A: male connector, M12, 4-pin, straight, D-coded Head B: Flying leads Cable: Ethernet, PUR, halogen-free, shielded, 5 m	STL-1204-G05ME90	6045285
	Head A: male connector, M12, 4-pin, straight, D-coded Head B: Flying leads Cable: Ethernet, PUR, halogen-free, shielded, 10 m	STL-1204-G10ME90	6045286
	Head A: male connector, M12, 4-pin, angled, D-coded Head B: Flying leads Cable: Ethernet, PUR, halogen-free, shielded, 2 m	STL-1204-W02ME90	6047912
	Head A: male connector, M12, 4-pin, angled, D-coded Head B: Flying leads Cable: Ethernet, PUR, halogen-free, shielded, 5 m	STL-1204-W05ME90	6047913
	Head A: male connector, M12, 4-pin, angled, D-coded Head B: Flying leads Cable: Ethernet, PUR, halogen-free, shielded, 10 m	STL-1204-W10ME90	6047914
	Head A: male connector, M12, 4-pin, angled, D-coded Head B: Flying leads Cable: Ethernet, PUR, halogen-free, shielded, 25 m	STL-1204-W25ME90	6047915
	Head A: female connector, M12, 4-pin, straight, A-coded Head B: Flying leads Cable: Sensor/actuator cable, PUR, halogen-free, unshielded, 2 m	YF2A14-020UB3XLEAX	2095607
	Head A: female connector, M12, 4-pin, straight, A-coded Head B: Flying leads Cable: Sensor/actuator cable, PUR, halogen-free, unshielded, 5 m	YF2A14-050UB3XLEAX	2095608
	Head A: female connector, M12, 4-pin, straight, A-coded Head B: Flying leads Cable: Sensor/actuator cable, PUR, halogen-free, unshielded, 10 m	YF2A14-100UB3XLEAX	2095609
	Head A: female connector, M12, 4-pin, straight, A-coded Head B: Flying leads Cable: Sensor/actuator cable, PUR, halogen-free, unshielded, 25 m	YF2A14-250UB3XLEAX	2095615
		Head A: female connector, M12, 4-pin, angled, A-coded Head B: Flying leads Cable: Sensor/actuator cable, PUR, halogen-free, unshielded, 2 m	YG2A14-020UB3XLEAX
Head A: female connector, M12, 4-pin, angled, A-coded Head B: Flying leads Cable: Sensor/actuator cable, PUR, halogen-free, unshielded, 5 m		YG2A14-050UB3XLEAX	2095767
Head A: female connector, M12, 4-pin, angled, A-coded Head B: Flying leads Cable: Sensor/actuator cable, PUR, halogen-free, unshielded, 10 m		YG2A14-100UB3XLEAX	2095768
Head A: female connector, M12, 4-pin, angled, A-coded Head B: Flying leads Cable: Sensor/actuator cable, PUR, halogen-free, unshielded, 25 m		YG2A14-250UB3XLEAX	2095771
	Head A: male connector, M12, 4-pin, straight, D-coded Head B: male connector, M12, 4-pin, straight, D-coded Cable: Ethernet, PUR, halogen-free, shielded, 2 m	SSL-1204-G02ME90	6045222
	Head A: male connector, M12, 4-pin, straight, D-coded Head B: male connector, M12, 4-pin, straight, D-coded Cable: Ethernet, PUR, halogen-free, shielded, 5 m	SSL-1204-G05ME90	6045277
	Head A: male connector, M12, 4-pin, straight, D-coded Head B: male connector, M12, 4-pin, straight, D-coded Cable: Ethernet, PUR, halogen-free, shielded, 10 m	SSL-1204-G10ME90	6045279

	Brief description	Type	Part no.
	Head A: male connector, M12, 4-pin, angled, D-coded Head B: male connector, M12, 4-pin, straight, D-coded Cable: Ethernet, PUR, halogen-free, shielded, 2 m	SSL-1204-H02ME90	6047908
	Head A: male connector, M12, 4-pin, angled, D-coded Head B: male connector, M12, 4-pin, straight, D-coded Cable: Ethernet, PUR, halogen-free, shielded, 5 m	SSL-1204-H05ME90	6047909
	Head A: male connector, M12, 4-pin, angled, D-coded Head B: male connector, M12, 4-pin, straight, D-coded Cable: Ethernet, PUR, halogen-free, shielded, 10 m	SSL-1204-H10ME90	6047910
	Head A: male connector, M12, 4-pin, straight, D-coded Head B: male connector, RJ45, 8-pin, straight Cable: Ethernet, PUR, halogen-free, shielded, 2 m	SSL-2J04-G02ME60	6047916
	Head A: male connector, M12, 4-pin, straight, D-coded Head B: male connector, RJ45, 8-pin, straight Cable: Ethernet, PUR, halogen-free, shielded, 5 m	SSL-2J04-G05ME60	6047917
	Head A: male connector, M12, 4-pin, straight, D-coded Head B: male connector, RJ45, 8-pin, straight Cable: Ethernet, PUR, halogen-free, shielded, 10 m	SSL-2J04-G10ME60	6047918
	Head A: male connector, M12, 4-pin, angled, D-coded Head B: male connector, RJ45, 8-pin, straight Cable: Ethernet, PUR, halogen-free, shielded, 2 m	SSL-2J04-H02ME	6047911
	Head A: male connector, M12, 4-pin, angled, D-coded Head B: male connector, RJ45, 8-pin, straight Cable: Ethernet, PUR, halogen-free, shielded, 5 m	SSL-2J04-H05ME	6045287
	Head A: male connector, M12, 4-pin, angled, D-coded Head B: male connector, RJ45, 8-pin, straight Cable: Ethernet, PUR, halogen-free, shielded, 10 m	SSL-2J04-H10ME	6045288
	Head A: female connector, M12, 4-pin, straight, D-coded Head B: - Cable: Ethernet, shielded	DOS-1204-GE	6048153
	Head A: female connector, M12, 4-pin, angled Head B: - Cable: unshielded	DOS-1204-W	6007303
	Head A: female connector, M12, 4-pin, angled, D-coded Head B: - Cable: Ethernet, shielded	DOS-1204-WE	6048154
	Head A: male connector, RJ45, 8-pin, straight Head B: - Cable: EtherNet/IP™, shielded	STE-0J08-GE	6048150
	Head A: male connector, M12, 4-pin, straight, D-coded Head B: - Cable: Ethernet, shielded	STE-1204-GE01	6048151
	Head A: male connector, M12, 4-pin, angled, D-coded Head B: - Cable: Ethernet, shielded	STE-1204-WE	6048152
	Head A: female connector, M12, 4-pin, D-coded Head B: female connector, RJ45, 8-pin Cable: Ethernet, shielded Cabinet through	Feedthrough female connector Ethernet RJ45	6048180

SICK AT A GLANCE

SICK is one of the leading manufacturers of intelligent sensors and sensor solutions for industrial applications. A unique range of products and services creates the perfect basis for controlling processes securely and efficiently, protecting individuals from accidents and preventing damage to the environment.

We have extensive experience in a wide range of industries and understand their processes and requirements. With intelligent sensors, we can deliver exactly what our customers need. In application centers in Europe, Asia and North America, system solutions are tested and optimized in accordance with customer specifications. All this makes us a reliable supplier and development partner.

Comprehensive services complete our offering: SICK LifeTime Services provide support throughout the machine life cycle and ensure safety and productivity.

For us, that is “Sensor Intelligence.”

WORLDWIDE PRESENCE:

Contacts and other locations –www.sick.com