

# Collaborative Robots

# TM5

## Collaborative robot for assembly, packaging, inspection and logistics

- Designed to promote a safe and harmonious workplace between humans and machines.
- Easy-to-use graphical programming environment for quick startup and operation.
- Built-in vision-based robot control enables visual serving, inspection, and measurement operations.
- TMvision and landmark allows truly flexible, fast changeover.
- Plug & Play ecosystem provides the tools and versatility for many manufacturing needs.
- Capability to integrate with mobile robots enables fully autonomous machine tending and logistics handling applications.



## Specification

Product Name		TM5-700	TM5M-700	TM5M-700 SEMI	TM5-900	TM5M-900	TM5M-900 SEMI
Part Number		RT6-000700X	RT6-010700X	RT6-000701X	RT6-000900X	RT6-010900X	RT6-010901X
Weight (kg)		22.1			22.6		
Controller Weight (kg)		13.5	14.5	14.5	13.5	14.5	14.5
Max Payload (kg)		6			4		
Reach (mm)		700			900		
Mounting		Wall, Table, Ceiling					
Typical Speed (m/s)		1.1			1.4		
Joint Range	Joint 1	±270°					
	Joint 2, 4, 5	±180°					
	Joint 3	±155°					
	Joint 6	±270°					
Joint Speeds	Joint 1, 2, 3	180°/s					
	Joint 4, 5, 6	225°/s					
Repeatability (mm)		±0.05					
IP		IP54 (robot arm), IP32 (control box), IP40 (robot stick)					
Cleanroom Class		ISO Class 5					
Operating Temperature and Humidity		0 to 50°C, 85% max. (with no condensation)					
Storage Temperature and Humidity		-20 to 60°C, 75% max. (with no condensation)					
Operating and Storage Atmosphere		No corrosive gases					
Power Supply		100-240 VAC, 50-60 Hz	22-60 VDC	22-60 VDC	100-240 VAC, 50-60 Hz	22-60 VDC	22-60 VDC
Robot Arm Cable Length		3m/12m	1.5m	1.5m	3m/12m	1.5m	1.5m
I/O Ports	Control Box	Digital In: 16 Digital Out: 16 Analog In: 2 Analog Out: 1					
	Tool	Digital In: 4 Digital Out: 4 Analog In: 1 Analog Out: 0					
I/O Interface		3 X COM, 1 X HDMI, 3 X LAN, 4 X USB2.0, 2 X USB3.0					
Communication		RS232, Ethernet (master), Modbus TCP/RTU (master & slave)					
Integrated Camera		5M pixels, color	5M pixels, color	5M pixels, color	5M pixels, color	5M pixels, color	5M pixels, color
I/O Power Supply		24V 1.5A (control box and tool)					
Programming Environment		TMflow, flowchart based					
SEMI S2 Certified*		No	No	Yes	No	No	Yes

\* SEMI safety SEMI safety guidelines are issued by an industry association with the same name: SEMI (Semiconductor Equipment and Materials International), which is the central global network of manufacturers of micro- and nano-electronics industries.

\* SEMI S2 is the most well-known standard in semiconductor manufacturing equipment for Environmental, Health, and Safety (EHS).



# Collaborative Robots

# TM12/14

## Collaborative robot for assembly, packaging, inspection and logistics

- Designed to promote a safe and harmonious workplace between humans and machines.
- Easy-to-use graphical programming environment for quick startup and operation.
- Built-in vision-based robot control enables visual serving, inspection, and measurement operations.
- TMvision and landmark allows truly flexible, fast changeover.
- Plug & Play ecosystem provides the tools and versatility for many manufacturing needs.
- Capability to integrate with mobile robots enables fully autonomous machine tending and logistics handling applications.



TM12

TM14

## Specifications

		TM12			TM14		
Product Name		TM12	TM12M	TM12M SEMI	TM14	TM14M	TM14M SEMI
Part Number		RT6-100130X	RT6-110130X	RT6-110131X	RT6-200110X	RT6-210110X	RT6-210111X
Weight (kg)		33.3			32.6		
Controller Weight (kg)		13.8	14.5	14.5	13.8	14.5	14.5
Max Payload (kg)		12			14		
Reach (mm)		1300			1100		
Mounting		Wall, Table, Ceiling					
Typical Speed (m/s)		1.3			1.1		
Joint Range	Joint 1	±270°					
	Joint 2, 4, 5	±180°					
	Joint 3	±166°			±163°		
	Joint 6	±270°					
Joint Speeds	Joint 1, 2	120°/s					
	Joint 3	180°/s					
	Joint 4, 5	180°/s			150°/s		
	Joint 6	180°/s					
Repeatability (mm)		±0.1					
IP		IP54 (robot arm), IP32 (control box), IP40 (robot stick)					
Cleanroom Class		ISO Class 5					
Operating Temperature and Humidity		0 to 50°C, 85% max. (with no condensation)					
Storage Temperature and Humidity		-20 to 60°C, 75% max. (with no condensation)					
Operating and Storage Atmosphere		No corrosive gases					
Power Supply		100-240 VAC, 50-60 Hz	22-60 VDC	22-60 VDC	100-240 VAC, 50-60 Hz	22-60 VDC	22-60 VDC
Robot Arm Cable Length		3m/12m	1.5m	1.5m	3m/12m	1.5m	1.5m
I/O Ports	Control Box	Digital In: 16 Digital Out: 16 Analog In: 2 Analog Out: 1					
	Tool	Digital In: 4 Digital Out: 4 Analog In: 1 Analog Out: 0					
I/O Interface		3 X COM, 1 X HDMI, 3 X LAN, 4 X USB2.0, 2 X USB3.0					
Communication		RS232, Ethernet (master), Modbus TCP/RTU (master & slave)					
Integrated Camera		5M pixels, color	5M pixels, color	5M pixels, color	5M pixels, color	5M pixels, color	5M pixels, color
I/O Power Supply		24V 1.5A (control box and tool)					
Programming Environment		TMflow, flowchart based					
SEMI S2 Certified*		No	No	Yes	No	No	Yes

\* SEMI safety guidelines are issued by an industry association with the same name: SEMI (Semiconductor Equipment and Materials International), which is the central global network of manufacturers of micro-and nano-electronics industries. SEMI S2 is the most well-known standard in semiconductor manufacturing equipment for EHS.

# Dimensions

(Unit: mm)

## TM12

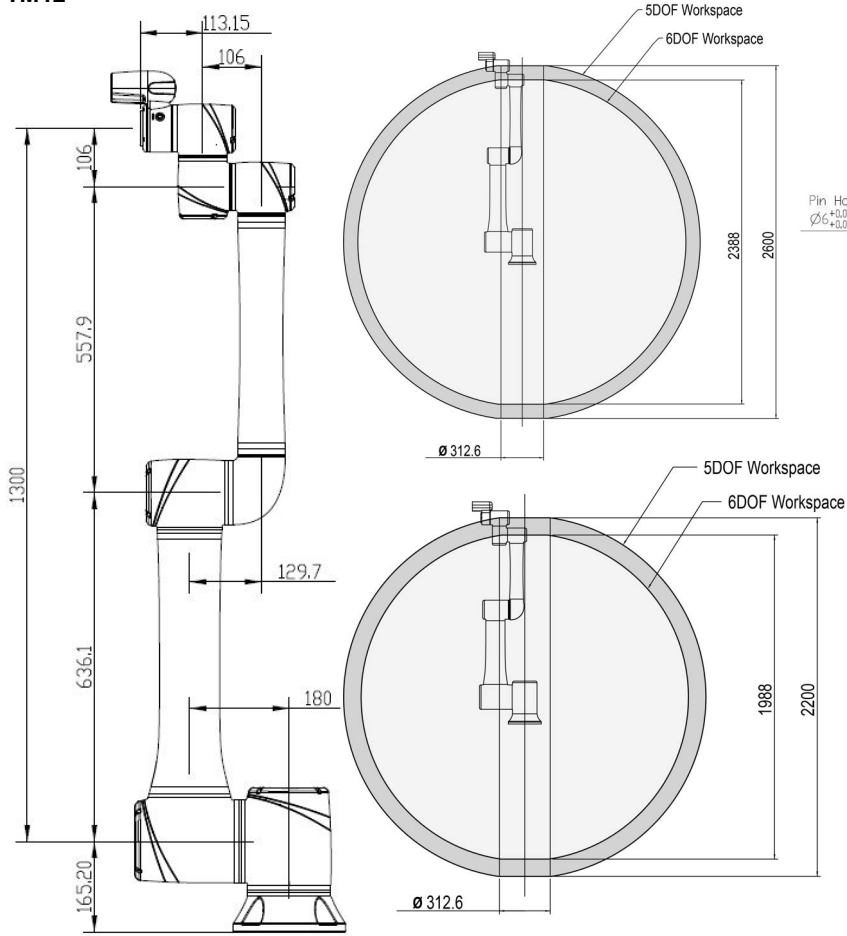

## Footprint

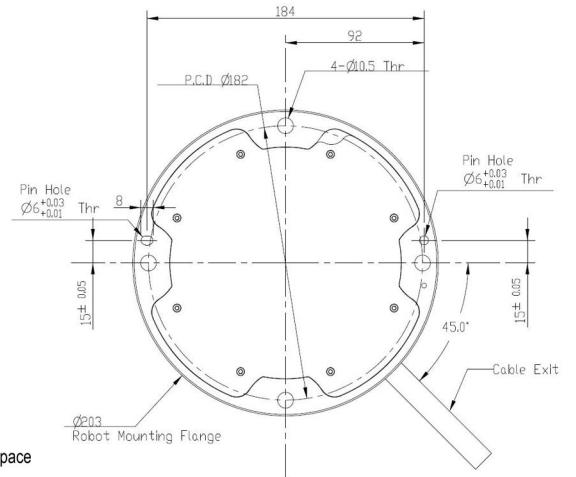

## Flange

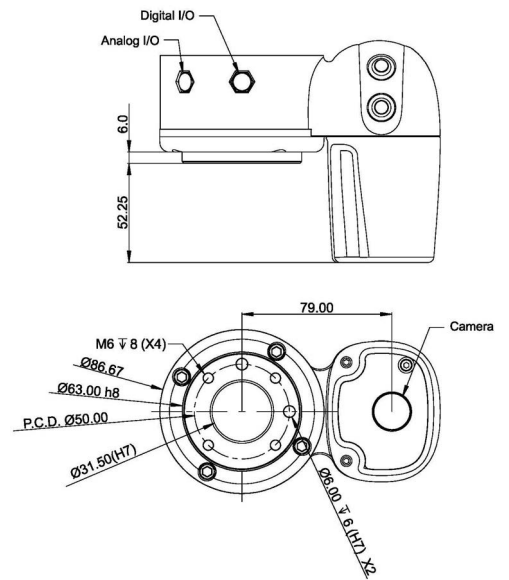

## TM14

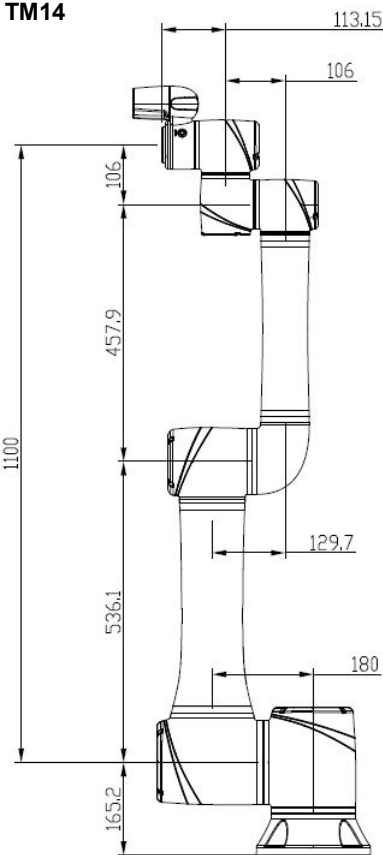



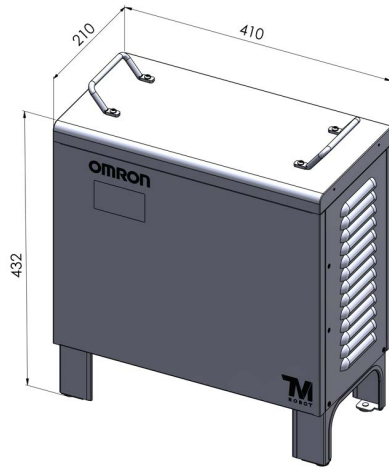



## Control Box

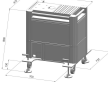
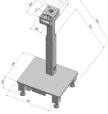

# Accessories & Software

## Accessories

Appearance	Product Name	Description	Remarks	Part Number
	Landmark	Robot positioning tool as a reference to the environment.	2 included with purchase of a robot.	RT6-A000021
	Mobile Workstation (MWS)	MWS is a convenient tool for users to mount the robot arm on work surface, and store the control box safely within. Users can move the MWS with the robot to different work cells easily.	Compatible with OMRON TM5 only.	RT6-A000010
	Robot stand	Similar to MWS, the robot stand can be moved with the robot to different work stations easily.	Height adjustable. Compatible with OMRON TM5 only.	RT6-A000009
	SSD with cable	128 GB solid state hard drive.	SATA cable included. Recommended for external cameras image logging.	RT6-A000012
	Kit, calibration set with additional pin	Toolkit for teaching a precise tool center point (TCP) that can be used for manual workspace calibration within TMvision	Required for TCP and manual vision calibration	RT6-A000002
	Robot stick stand	Mounting fixture for the robot stick.	Can be used on desktops, walls, and MWS.	RT6-A000000
	Pneumatic control box	Controls the inputs and outputs and monitors air pressure for Kilews screw driving applications.	Compatible with Kilews screw driving solution kit only. Recommended to attach to the robot stand.	RT6-A000015
	Air Filter (ROHS)	Replacement air filter for the control box.	The filter must be changed regularly to maintain efficiency. The replacement procedure can be found in the Hardware Installation Manual.	19936-443F

## Software

Product Name	Add-On Product Names	Part Number	Add-On Part Numbers	Remarks
USB Dongle	-	RT6-A000004	-	Required for all extra software licenses.
TMflow	-	N/A, Free Download	-	Software required to control the cobot.
	TM Identify & Measure	-	RT6-S100000	License, add-on to TMflow. Includes: identification of pose variation, specific color area size, subtract reference image, line/circle burr, counting and gauge.
	TM External Vision	-	RT6-S100002	License, add-on to TMflow. Required when using eye-to-hand cameras.
	TM OCR	-	RT6-S100003	License, add-on to TMflow. Includes: Text OCR and Number OCR.
	License, Omron-TM Operator Suite	-	RT6-S100006	License, includes 2 USB Dongles (1 for Laptop/PC, and 1 for additional IPC)
	License, Omron-TM Operator Runtime	-	RT6-S100007	License, includes 1 USB Dongles (for additional IPC)
	License, TMStudio Palletizing Wizard Export	-	RT6-S100008	License, includes 1 USB Dongles (for additional IPC)
	License, Omron-TM Operator Runtime and Palletizing Wizard Export	-	RT6-S100009	License, includes 1 USB Dongles (for additional IPC)
TMflow Editor	-	RT6-S200001	-	License, provides a convenient way to open and edit project offline.
	TMflow Editor - Offline AOI	-	RT6-S100005	License, add-on to TMflow Editor. Enables TMflow Editor to offline edit a TMflow project that includes AOI vision.

## Accessories Dimensions

### Mobile Work Station (MWS)

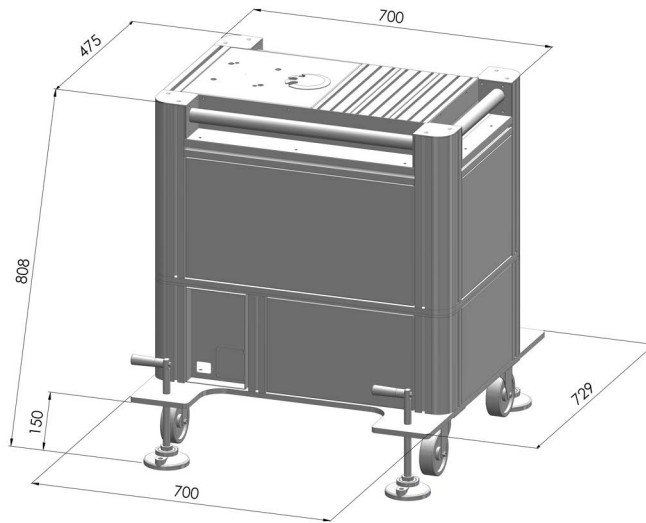



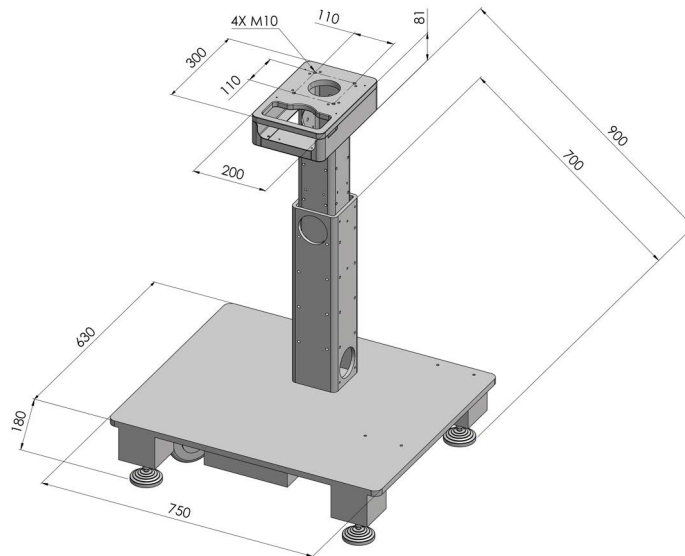



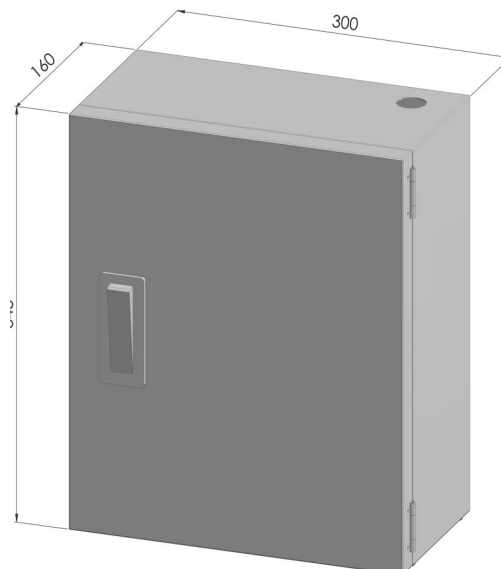





### Robot Stand





















### Pneumatic Control Box





















## Recommended Plug & Play Hardware

Category	Appearance	Company	Product Name	Manufacturer SKU Number*	Description
Grippers		Robotiq	Adaptive Gripper 2-Finger 85/140 for OMRON TM robot	85 kit: AGC-OMRON-KIT-85 140 kit: AGC-OMRON-KIT-140	A 2-finger adaptive gripper that can adapt to parts of various shapes and sizes. Comes in two stroke options – 85mm and 140mm. Each kit includes: - End effector coupling kit - 10-meter communication cable - RS485 to RS232 converter - RS485 to USB converter - Screw kit - Quick start guide
			Hand-E gripper for OMRON TM robot	HND-OMRON-KIT	A 2-finger parallel gripper with an IP67 rating. 50mm stroke. Each kit includes: - Fingertip starting kit - End effector coupling kit - 10-meter communication cable - RS485 to RS232 converter - RS485 to USB converter - Screw kit - Quick start guide
			EPick for Omron TM robot	VAC-OMRON-EPICK-KIT1	A vacuum gripper that uses an integrated vacuum generator. Each kit includes:
				VAC-OMRON-EPICK-KIT2	-Basic gripper unit -End effector coupling kit -10-meter communicable cable -RS485 to RS232 converter -RS485 to USB converter -Quick start guide -Vacuum cup(s): 1.5 bellows, 55mm diameter
				VAC-OMRON-EPICK-KIT4	KIT1 includes 1 vacuum cup KIT2 has a suction system for 2 cups KIT4 has a suction system for 4 cups
			AirPick for Omron TM robot	VAC-OMRON-AIRPICK-KIT1	A vacuum gripper that uses an external pneumatic supply. Each kit includes:
				VAC-OMRON-AIRPICK-KIT2	-Basic gripper unit -Tubing 8mm-8m -End effector coupling kit -RS485 to RS232 converter -RS485 to USB converter -Quick start guide -Vacuum cup(s): 1.5 bellows, 55mm diameter
				VAC-OMRON-AIRPICK-KIT4	KIT1 includes 1 vacuum cup KIT2 has a suction system for 2 cups KIT4 has a suction system for 4 cups
			I/O Coupling	IO-CPL-OMRON-KIT	Component that connects the Robotiq adaptive/vacuum gripper to the wrist of the OMRON TM robot to eliminate the need for an external serial communication cable. Each kit includes: - I/O Coupling - Screw kit - Micro-USB to USB cable - 16G USB Stick
			Dual-Grip Adapter Plate	AGC-APL-159-002	Adapter plate and mounting screws to mount two grippers onto the OMRON TM robot.
			2F-85 Dual kit for OMRON Robots 2F-140 Dual kit for OMRON Robots HAND-E Dual kit for OMRON Robots	OMRON-DUAL-AGC-85 OMRON-DUAL-AGC-140 OMRON-DUAL-HND	Kit that enables dual gripper setting. Each kit includes: - Chosen gripper x 2 - Mechanical coupling x 2 - USB to RS485 Adapter - Communication Cable - M12 5 Pins Splitter - Dual-Grip Adapter Plate - Screw kit x 2
		OnRobot	RG2 Gripper	102012	Electric 2-finger gripper. Each kit includes: - RG2 Gripper - Fingertip adapters (pre-mounted) - Integrated Quick Changer (tool side) - Torx key

Category	Appearance	Company	Product Name	Manufacturer SKU Number*	Description
Grippers		OnRobot	RG2-FT	102075	The RG2-FT has 2 force/torque sensors and 2 time-of-flight based proximity sensors integrated in the fingertips. It's a state of the art gripper with added sensing and intelligence, capable of controlling the robot and itself to achieve what the operator would like it to do, even when the exact parameters cannot be programmed in advance. It includes: - RG2-FT Gripper - Fingertip adapter (pre-mounted) - Cable - Cable holder and screws Required option for mounting on the robot: - single quick changer (robot side) - dual quick changer (robot side) - HEX QC Required option for connecting to the robot: - connection kit with compute box
			RG6 Gripper	102021	Electric 2-finger gripper with larger stroke. Each kit includes: - RG2 Gripper - Fingertip adapters (pre-mounted) - Integrated Quick Changer (tool side) - Torx key
			VG10 Electric Vacuum Gripper	101661	Flexible and adjustable electrical vacuum gripper. Each kit includes: - VG10 Gripper - d30mm suction cups x 16 (pre-mounted) - Integrated Quick Changer (tool side) - d40mm suction cups x4 - d15mm suction cups x4 - Blind screws x16 - Positioning arrows - Torx key
			Single Pad Gecko	104086 SP1 104087 SP3 104088 SP5	Compact, lightweight Gecko Single Pad Gripper requires no cables, electricity, air or programming. The Gecko SP is available in 3 sizes; SP1, SP3, and SP5 named after the grippers payload in kilos, featuring the ability to lift a wide range of flat, smooth, shiny or perforated surfaces. Options are: Gecko SP1 (with 35mm pad) Gecko SP3 (with 60mm pad) Gecko SP5 (with 75mm pad)
			OMRON TM Robot Kit	102359	This kit must be purchased for the use of OnRobot grippers on OMRON TM collaborative robot. Each kit includes: - Compute Box - Power supply - Adapter plate (included in all kits but only necessary for VG10 and Gecko grippers) - USB stick with software components and User Manual - Device cable 5m - UTP cable 0.5m - I/O cable 0.3m - Cable management hook/loop
			3FG15-3 Finger Gripper	103666	The 3FG15 is ideal for gripping a wide range of cylindrical objects in machine-tending applications such as CNC lathe machines. The grippers design automatically centers workpieces, with payload up to 15kg. It includes: - 3FG15 - Torx Key T20 - 3 x Steel Fingertip Ø13 - 3 x Rubber Fingertip Ø 16,5
			Soft Gripper	103546 SG Base Part 103689 SG-a-H 103860 SG-a-S 103691 SG-b-H	This is available with three interchangeable silicon-molded cups to handle a wide array of irregular shapes and delicate items, making it ideal for pick-and-place applications in food and beverage and other "clean" production applications. The silicon cups are dishwasher-safe and comply with FDA 21 CFR (for non-fatty items) and EC 1935/2004 for food handling. Maximum payload of 2.2 kg, and grip dimensions range from 11mm to 118mm, depending on cup used.
Vision		Basler	GigE camera, color, 5MP, CMOS 2/3", 23fps	acA2440-20gc, Global Shutter	External camera for eye-to-hand robot applications. Maximum 2 external cameras per robot.
			GigE camera, mono, 5MP, CMOS 2/3", 23 fps	acA2440-20gm, Global Shutter	
			GigE, camera, color, 10MP, CMOS 1/2.3", 10 fps	acA3800-10gc, Rolling Shutter	
			GigE, camera, mono, 10MP, CMOS 1/2.3", 10 fps	acA3800-10gm, Rolling Shutter	
			GigE, camera, color, 12.2 MP, CMOS 1/1.7", 8 fps	acA4024-8gc, Rolling Shutter	
			GigE, camera, mono, 12.2 MP, CMOS 1/1.7", 8 fps	acA4024-8gm, Rolling Shutter	

Grippers		OnRobot	VGC10	102844	This flexible electric vacuum gripper has changeable suction cup options for unlimited customization possibilities. It's smaller and at half the weight of VG10 but with the same payload. It includes: <ul style="list-style-type: none"> <li>- D40mm Vacuum Cups</li> <li>- D30mm Vacuum Cups</li> <li>- D15mm Vacuum Cups</li> <li>- Fittings</li> <li>- Push-in fittings</li> <li>- M6x10mm Screws</li> <li>- Blind Screws</li> <li>- Torx T30</li> <li>- Allen 3mm Keys</li> <li>- Adapter Plate</li> <li>- Extension pipe 50mm</li> </ul>
		Schmalz	ROB-SET ECBPi OMRON	10.03.01.00544	Complete vacuum gripper for collaborative robots. Each kit includes: <ul style="list-style-type: none"> <li>- Vacuum generator (ECBPi)</li> <li>- End-effector coupling kit</li> <li>- Connection cable</li> <li>- Mounting flange</li> <li>- Flat suction cup</li> <li>- Bellows suction cup</li> <li>- Bolts and t-nuts</li> <li>- Operating instructions</li> </ul>
			ROB-SET FXCB OMRON	10.01.43.00120	Area gripper equipped with integrated pneumatic vacuum generation. (Needs external air supply.) Each kit includes: <ul style="list-style-type: none"> <li>- Pneumatic area gripper (FXCB)</li> <li>- Connection cable</li> <li>- Mounting flange</li> <li>- Bolts and t-nuts</li> <li>- Operating instructions</li> </ul>
		Schunk	Co-act EGP-C 40 N-N-TMID	1374363	Electric 2-finger parallel gripper certified for collaborative operation with actuation via 24 V and digital I/O. Each kit includes: <ul style="list-style-type: none"> <li>- Co-act EGP-C gripper</li> <li>- Assembly and Operating Manual</li> <li>- Accessory pack</li> </ul>
			Co-act AUB EGP 40/12 Co-act AUB EGP 40/24 Co-act AUB-F EGP 40/xx	1401285 1401286 1409839	Gripping fingers for Co-act EGP-C.
		SMC	Air Gripper	JMHZ2X7400B-TM	Air gripper equipped with a high precision linear guide. Compact, lightweight product with high gripping force due to air operation. Operate by simply connecting one air supply tube and an electrical wiring M8 connector. Each kit includes: <ul style="list-style-type: none"> <li>- Air gripper unit</li> <li>- Parallel pin (6x10mm) x 1</li> <li>- Hexagon socket head cap screw (M6x23) x 4</li> <li>- Protective cover x1 set (valve side, S.W side)</li> <li>- Hexagon socket head cap screw (M4x10) x 4</li> <li>- Tube for piping (TU0425BU) 2m</li> <li>- User manual</li> </ul>
			Vacuum Gripper	ZXP-X1	Operate by simply connecting one compressed air supply tube and an electrical wiring M8 connector. The wide variety of SMC suction cup variations can apply to a wide range of picking applications. The adsorbing detection is made easy with sensor signals. Each kit includes: <ul style="list-style-type: none"> <li>- Vacuum gripper unit</li> <li>- Robot mounting flange</li> <li>- 6x10, parallel pin</li> <li>- 8 pcs x M6 x 10, Hexagon socket head cap screw</li> <li>- 2m, Polyurethane tube: TU0604</li> <li>- Plug 4 pcs (cup mounting flange)</li> <li>- 4 pcs x suction cup with adapter (suction cup)</li> </ul>
		CKD	Compact Gripper RLSH-TM	RLSH-A20D1N-L1-FY2-TM	Small, lightweight, pneumatic gripper with high gripping force. Easy installation with a dedicated common flange and tool-less replacement with a clamp ring, and teaching support is supported with the dedicated software "Pneumatic Gripper." Equipped with an edgeless resin cover and an LED indicator lamp that is visible 360 degrees, it is designed with consideration for safety and supports the introduction of collaborative robots by all customers.
	Long Stroke Gripper RHLF-TM		RHLF-16CS-FY2-TM		
	3-way Finger Gripper RCKL-TM		RCKL-16CS-FY3-TM		

Tool Changers		KOSMEK	Robotic Tool Changer	Master Cylinder: SWR0070-M□-□ SWR0120-M□-□ Conversion Plate Set: SWRZ0070-MF4 SWRZ0120-MF4 Tool Adapter: SWR0070-T- □ SWR0120-T-□	High-precision robotic tool changer with many features enables multiple functions of robots and setup time reduction. It enhances the productivity of the automated production line.
		OnRobot	Quick Changer - Robot Side	102037	Manual tool changer to attach on the robot's end-of-arm. Either the Quick Changer (robot side) or the Dual Quick Changer must be purchased for use of all OnRobot grippers. Each kit includes: - Quick Changer robot side - Screws - Torx key
			Quick Changer - Tool Side	102014	Manual tool changer to attach on the tool side. (All OnRobot grippers have this component integrated, so this is only necessary when user is developing own tool.)
			Quick Changer Kit	102277	Each kit includes: - Quick Changer (robot side)x1 - Quick Changer (tool side)x2 - Torx key - Screws and pins
			Dual Quick Changer	101788	Manual tool changer to attach on the robot's end-of-arm for dual gripper configuration. Either the Quick changer (robot side) or the Dual Quick Changer must be purchased for use of all OnRobot grippers. Each kit includes: - Dual Quick Changer - Screws - Torx key
3D Bin Picking		Pick-it	Pick-it M	PI-M-2.0	Plug & Play 3D camera and software for picking objects sized 50x50x10mm or larger. Each kit includes: - Pre-calibrated 3D camera - Pick-it software - Industrial processor - 3G dongle to connect directly to Pick-it support - Calibration plate and ROI box teaching markers - All connection cables (plug & play) - Quick start guide
			Pick-it M-HD	PI-M-HD	Plug & Play 3D camera and software for picking objects sized 10x10x5mm or larger. Each kit includes: - Pre-calibrated 3D camera - Pick-it software - Industrial processor - 3G dongle to connect directly to Pick-it support - Calibration plate and ROI box teaching markers - All connection cables (plug & play) - Quick start guide
Screw Driving		Kilews	Screw Driving Solution Kit	-	Kilews screwdriver kit and pneumatic control box. Each kit includes: - Screwdriver SKD-BN512LM - Power Controller SKP-32BC-60W - Flange E31700-3 - Air Nozzle KD-TM-B500 - Signal box - Pneumatic control box - Installation guide
Vision		Basler	GigE camera, color, 5MP, CMOS 1/2.5", 14 fps	acA2500-14gc, Rolling Shutter	External camera for eye-to-hand robot applications.Maximum 2 external cameras per robot.
			GigE camera, mono, 5MP, CMOS 1/2.5", 14 fps	acA2500-14gm, Rolling Shutter	
			GigE camera, color, 5MP, CMOS 1", 21fps	acA2500-20gc, Global Shutter	
			GigE camera, mono, 5MP, CMOS 1", 21 fps	acA2500-20gm, Global Shutter	

Category	Appearance	Company	Product Name	Manufacturer SKU Number*	Description
Force sensor		ATI	Axia80	9105-TM-Axia80	Six-axis force/torque sensor with EtherCAT communication. Each kit includes: - Interface plate - Power and Ethernet cable - Digital delivery of calibration documents and user manual
		Robotiq	FT-300	FTS-300-OMRON-KIT	Six-axis force/torque sensor with RS485 Serial Communication. Each kit includes: - Coupling - RS485 to RS232 converter - Power and communication cable with USB adapter - Screw kit
		OnRobot	HEX-E/H	- 100551 HEX-H w/ EtherCAT Converter & Flange A - 100535 HEX-E w/ EtherCAT Converter & Flange A	HEX six-axis force torque sensors use a unique, optical principle to detect the smallest forces acting on the tool, with EtherCAT communication. The OnRobot force control software package is optimized for these sensors. It includes: - HEX-E or HEX H - Mounting plate - Screws - Cable - Torx key Required to connect the sensor to the robots: - Connection kit with Compute Box
7th Axis		Ewellix	LIFTKIT	LIFTKIT-OM-601	A ready-to-install system that includes a telescopic column with a mounting interface and controller. Stroke options (mm): 500, 600, 700, 800, 900. Each kit includes: -Telescopic pillar -Controller -TM attachment plate -Bottom fixation plate -Handswitch -Cables and screws
Connectivity		ADLINK	EtherCAT I/O Expansion Modules KIT	EPS - 9905+6000+203 2+1132	A Kit that includes: chassis w/ EtherCAT ports and voltage input, 32-channel digital output module, 32-channel digital input module.
			EtherCAT I/O Expansion Modules (DO Module)	EPS-2032	32-channel digital output module.
			EtherCAT I/O Expansion Modules (DI Module)	EPS-1132	32-channel digital input module.
		Advantech	Serial Device Server EKI-1524-CE	EKI-1524-CE	External device with serial ports that communicates with the robot via TCP/IP.
			Modbus to PROFINET Gateways	EKI-1242IPNMS	A gateway to transform Omron TM cobot's Modbus to PROFINET, whereby Omron TM cobot as slave could communicate with PROFINET master devices.
Cable Management		Murrplastik	FHS-C-SET TM5 (TM5-700 & TM5-900)	83693500	Cable management dress pack. Each kit includes: Conduit (Cable routing hose, Length:2m, Interior diameter: ~21mm) 4x Attachment straps 2x End plugs Cable insertion tool Installation instructions
			FHS-C-SET TM12 / TM14 (TM12 & TM14)	83693501	
		Murrplastik	FHS-RS-SET TM5 (TM5-700 & TM5-900)	83693506	Cable management dress pack. Each kit includes: Conduit (Cable routing hose, Length:2m, Interior diameter: ~21mm) 2x Conduit clamps Self-retracting hose guide (2x Ball joint fixing, Ball joint strain relief, Feedback system, System holder)
			FHS-RS-SET TM12 / TM14 (TM12 & TM14)	83693507	Tool-end clamp End sleeve Cable puller Installation instructions
Simulation Software		RoboDK	RoboDk Simulation Software	N/A, Download	RoboDK is a powerful and cost-effective simulator and programming tool. No programming skills are required to generate complex robot path. Custom 3D model can be imported to quickly simulate real life application.
Teach Pendant		NexCobot	TP-100-1	TP Package-Plug&Play for OM	A handheld operating teach pendant and well-integrated with OMRON TM Robot. Features an ergonomic housing with safety elements, 10.1" WXGA resolution panel and multi-touch p-cap.

## Ordering Information

### Model Number Legend

# RT6 - 0 0 0 7 0 0 0

(1) (2) (3) (4) (5) (6) (7) (8)

No.	Item	Specifications	Symbol
(1)	Collaborative Robots - Techman		
(2)	Model Type	TM5	0
		TM12	1
		TM14	2
(3)	Power Supply	AC	0
		DC	1
(4)	Eye in Hand	Standard	0
		X Model*	1
(5)(6)	Arm Length	700 (TM5)	70
		900 (TM5)	90
		1300 (TM12)	13
		1100 (TM14)	11
(7)	Semi	Standard	0
		Semi	1
(8)	Cable Length	Standard Length (3m/1.5m)*	1
		Extended Length (12m)*	2

\* X model refers to robot models without integrated camera system.

\* 1.5m cable is only standard on DC models.

\* 12m cable is not available on DC models.

### Cobot Part Number List

Type	Part Number
TM5-700	RT6-0007001
TM5-700, 12m cable	RT6-0007002
TM5X-700	RT6-0017001
TM5X-700, 12m cable	RT6-0017002
TM5M-700	RT6-0107001
TM5M-700 SEMI	RT6-0107011
TM5MX-700	RT6-0117001
TM5-900	RT6-0009001
TM5-900, 12m cable	RT6-0009002
TM5X-900	RT6-0019001
TM5X-900, 12m cable	RT6-0019002
TM5M-900	RT6-0109001
TM5M-900 SEMI	RT6-0109011
TM5MX-900	RT6-0119001
TM12	RT6-1001301
TM12, 12m cable	RT6-1001302
TM12X	RT6-1011301
TM12X, 12m cable	RT6-1011302
TM12M	RT6-1101301
TM12M SEMI	RT6-1101311
TM12MX	RT6-1111301
TM14	RT6-2001101
TM14, 12m cable	RT6-2001102
TM14X	RT6-2011101
TM14X, 12m cable	RT6-2011102
TM14M	RT6-2101101
TM14M SEMI	RT6-2101111
TM14MX	RT6-2111101

### Accessories Part Number List

Type	Part Number
Landmark	RT6-A000021
Mobile Workstation (MWS)	RT6-A000010
Robot stand	RT6-A000009
SSD with cable	RT6-A000012
Kit, calibration set with additional pin	RT6-A000002
Robot stick stand	RT6-A000000
Pneumatic control box	RT6-A000015
Air Filter (ROHS)	19936-443F

### Software Part Number List

Type	Part Number
USB Dongle	RT6-A000004
TMflow	N/A, Free Download
TM Identify & Measure	RT6-S100000
TM External Vision	RT6-S100002
TM OCR	RT6-S100003
License, Omron-TM Operator Suite	RT6-S100006
License, Omron-TM Operator Runtime	RT6-S100007
License, TMStudio Palletizing Wizard Export	RT6-S100008
License, Omron-TM Operator Runtime and Palletizing Wizard Export	RT6-S100009
TMflow Editor	RT6-S200001
TMflow Editor - Offline AOI	RT6-S100005

## Related Manuals

Manual No.	English Title
I623	TM5 Regular Payload Series Hardware Installation Manual
I624	TM12 & TM14 Medium & Heavy Payload Series Hardware Installation Manual
I626	Software Manual TMflow
I627	Software Manual TMvision
I628	TM Mobile Work Station Manual
I629	TM Robot Stand Manual
I630	Pneumatic Control Box Manual
I648	Safety Manual
I662	TM Operator Platform Manual
I664	TM Script Language Manual
I848	Expression Editor and Listen Node Reference Guide
I853	TM Conveyor Tracking Manual

## Robot Parts Code and Bundled Accessories

Type	TM5-700					TM5-900				
	TM5-700	TM5M-700	TM5M-700 SEMI	TM5X-700	TM5MX-700	TM5-900	TM5M-900	TM5M-900 SEMI	TM5X-900	TM5MX-900
Product Name										
Part Number	RT6-000700X	RT6-010700X	RT6-010701X	RT6-001700X	RT6-011700X	RT6-000900X	RT6-010900X	RT6-010901X	RT6-001900X	RT6-011900X
Overview	Robot and control box with built-in vision system				Robot and control box without vision system	Robot and control box with built-in vision system			Robot and control box without vision system	
Purpose	Typical for use in single collaborative robot system					Typical for use in single collaborative robot system				
Bundled Accessories	<ul style="list-style-type: none"> <li>TM5-700 robot arm (1), standard cable length 300 cm, optional 600 cm and 1200 cm</li> <li>Robot stick (1), 300 cm</li> <li>Control box (1)</li> <li>Calibration plates (one large and one small) (not included with the X model bundles)</li> <li>IO cables,(2 ) 100 cm</li> <li>Landmark (2) (not included with the X model bundles)</li> <li>Ground wire (2), 300 cm</li> <li>Jumper wire (2), 3 cm</li> <li>Power cable for the control box,(4 cable, Type B, I, G, F), 180 cm, (4 standard part number, 1 mobile part number)</li> <li>SEMI emergency OFF switch (SEMI model only)</li> <li>SEMI Estop cable (1), 300 cm</li> </ul>					<ul style="list-style-type: none"> <li>TM5-900 robot arm (1), standard cable length 300 cm, optional 600 cm and 1200 cm</li> <li>Robot stick (1), 300 cm</li> <li>Control box (1)</li> <li>Calibration plates (one large and one small) (not included with the X model bundles)</li> <li>IO cables,(2 ) 100 cm</li> <li>Landmark (2) (not included with the X model bundles)</li> <li>Ground wire (2), 300 cm</li> <li>Jumper wire (2), 3 cm</li> <li>Power cable for the control box,(4 cable, Type B, I, G, F), 180 cm, (4 standard part number, 1 mobile part number)</li> <li>SEMI emergency OFF switch (SEMI model only)</li> <li>SEMI Estop cable (1), 300 cm</li> </ul>				

Type	TM12					TM14				
	TM12	TM12M	TM12M SEMI	TM12X	TM12MX	TM14	TM14M	TM14M SEMI	TM14X	TM14MX
Product Name										
Part Number	RT6-100130X	RT6-110130X	RT6-110131X	RT6-101130X	RT6-111130X	RT6-200110X	RT6-210110X	RT6-210111X	RT6-201110X	RT6-211110X
Overview	Robot and control box with built-in vision system				Robot and control box without vision system	Robot and control box with built-in vision system			Robot and control box without vision system	
Purpose	Typical for use in single collaborative robot system					Typical for use in single collaborative robot system				
Bundled Accessories	<ul style="list-style-type: none"> <li>TM12 robot arm (1), standard cable length 300 cm, optional 600 cm and 1200 cm</li> <li>Robot stick (1), 300 cm</li> <li>Control box (1)</li> <li>Calibration plates (one large and one small) (not included with the X model bundles)</li> <li>IO cables,(2 ) 100 cm</li> <li>Landmark (2) (not included with the X model bundles)</li> <li>Ground wire (2), 300 cm</li> <li>Jumper wire (2), 3 cm</li> <li>Power cable for the control box,(4 cable, Type B, I, G, F), 180 cm, (4 standard part number, 1 mobile part number)</li> <li>SEMI emergency OFF switch (SEMI model only)</li> <li>SEMI Estop cable (1), 300 cm</li> </ul>					<ul style="list-style-type: none"> <li>TM14 robot arm (1), standard cable length 300 cm, optional 600 cm and 1200 cm</li> <li>Robot stick (1), 300 cm</li> <li>Control box (1)</li> <li>Calibration plates (one large and one small) (not included with the X model bundles)</li> <li>IO cables,(2 ) 100 cm</li> <li>Landmark (2) (not included with the X model bundles)</li> <li>Ground wire (2), 300 cm</li> <li>Jumper wire (2), 3 cm</li> <li>Power cable for the control box,(4 cable, Type B, I, G, F), 180 cm, (4 standard part number, 1 mobile part number)</li> <li>SEMI emergency OFF switch (SEMI model only)</li> <li>SEMI Estop cable (1), 300 cm</li> </ul>				

\* Please note the calibration plates and landmark are not included with the X model bundles.

# Terms and Conditions Agreement

## **Read and understand this catalog.**

Please read and understand this catalog before purchasing the products. Please consult your OMRON representative if you have any questions or comments.

## **Warranties.**

- (a) Exclusive Warranty. Omron's exclusive warranty is that the Products will be free from defects in materials and workmanship for a period of twelve months from the date of sale by Omron (or such other period expressed in writing by Omron). Omron disclaims all other warranties, express or implied.
- (b) Limitations. OMRON MAKES NO WARRANTY OR REPRESENTATION, EXPRESS OR IMPLIED, ABOUT NON-INFRINGEMENT, MERCHANTABILITY OR FITNESS FOR A PARTICULAR PURPOSE OF THE PRODUCTS. BUYER ACKNOWLEDGES THAT IT ALONE HAS DETERMINED THAT THE PRODUCTS WILL SUITABLY MEET THE REQUIREMENTS OF THEIR INTENDED USE.

Omron further disclaims all warranties and responsibility of any type for claims or expenses based on infringement by the Products or otherwise of any intellectual property right. (c) Buyer Remedy. Omron's sole obligation hereunder shall be, at Omron's election, to (i) replace (in the form originally shipped with Buyer responsible for labor charges for removal or replacement thereof) the non-complying Product, (ii) repair the non-complying Product, or (iii) repay or credit Buyer an amount equal to the purchase price of the non-complying Product; provided that in no event shall Omron be responsible for warranty, repair, indemnity or any other claims or expenses regarding the Products unless Omron's analysis confirms that the Products were properly handled, stored, installed and maintained and not subject to contamination, abuse, misuse or inappropriate modification. Return of any Products by Buyer must be approved in writing by Omron before shipment. Omron Companies shall not be liable for the suitability or unsuitability or the results from the use of Products in combination with any electrical or electronic components, circuits, system assemblies or any other materials or substances or environments. Any advice, recommendations or information given orally or in writing, are not to be construed as an amendment or addition to the above warranty.

See <http://www.omron.com/global/> or contact your Omron representative for published information.

## **Limitation on Liability; Etc.**

OMRON COMPANIES SHALL NOT BE LIABLE FOR SPECIAL, INDIRECT, INCIDENTAL, OR CONSEQUENTIAL DAMAGES, LOSS OF PROFITS OR PRODUCTION OR COMMERCIAL LOSS IN ANY WAY CONNECTED WITH THE PRODUCTS, WHETHER SUCH CLAIM IS BASED IN CONTRACT, WARRANTY, NEGLIGENCE OR STRICT LIABILITY.

Further, in no event shall liability of Omron Companies exceed the individual price of the Product on which liability is asserted.

## **Suitability of Use.**

Omron Companies shall not be responsible for conformity with any standards, codes or regulations which apply to the combination of the Product in the Buyer's application or use of the Product. At Buyer's request, Omron will provide applicable third party certification documents identifying ratings and limitations of use which apply to the Product. This information by itself is not sufficient for a complete determination of the suitability of the Product in combination with the end product, machine, system, or other application or use. Buyer shall be solely responsible for determining appropriateness of the particular Product with respect to Buyer's application, product or system. Buyer shall take application responsibility in all cases.

NEVER USE THE PRODUCT FOR AN APPLICATION INVOLVING SERIOUS RISK TO LIFE OR PROPERTY OR IN LARGE QUANTITIES WITHOUT ENSURING THAT THE SYSTEM AS A WHOLE HAS BEEN DESIGNED TO ADDRESS THE RISKS, AND THAT THE OMRON PRODUCT(S) IS PROPERLY RATED AND INSTALLED FOR THE INTENDED USE WITHIN THE OVERALL EQUIPMENT OR SYSTEM.

## **Programmable Products.**

Omron Companies shall not be responsible for the user's programming of a programmable Product, or any consequence thereof.

## **Performance Data.**

Data presented in Omron Company websites, catalogs and other materials is provided as a guide for the user in determining suitability and does not constitute a warranty. It may represent the result of Omron's test conditions, and the user must correlate it to actual application requirements. Actual performance is subject to the Omron's Warranty and Limitations of Liability.

## **Change in Specifications.**

Product specifications and accessories may be changed at any time based on improvements and other reasons. It is our practice to change part numbers when published ratings or features are changed, or when significant construction changes are made. However, some specifications of the Product may be changed without any notice. When in doubt, special part numbers may be assigned to fix or establish key specifications for your application. Please consult with your Omron representative at any time to confirm actual specifications of purchased Product.

## **Errors and Omissions.**

Information presented by Omron Companies has been checked and is believed to be accurate; however, no responsibility is assumed for clerical, typographical or proofreading errors or omissions.

**OMRON Corporation Industrial Automation Company**  
Kyoto, JAPAN

Contact: [www.ia.omron.com](http://www.ia.omron.com)

**Regional Headquarters**

**OMRON EUROPE B.V.**

Wegalaan 67-69, 2132 JD Hoofddorp  
The Netherlands  
Tel: (31)2356-81-300/Fax: (31)2356-81-388

**OMRON ASIA PACIFIC PTE. LTD.**

No. 438A Alexandra Road # 05-05/08 (Lobby 2),  
Alexandra Technopark,  
Singapore 119967  
Tel: (65) 6835-3011/Fax: (65) 6835-2711

**OMRON ELECTRONICS LLC**

2895 Greenspoint Parkway, Suite 200 Hoffman Estates,  
IL 60169 U.S.A.  
Tel: (1) 847-843-7900/Fax: (1) 847-843-7787

**OMRON ROBOTICS AND SAFETY TECHNOLOGIES, INC.**

4225 Hacienda Drive, Pleasanton, CA 94588 U.S.A.  
Tel: (1) 925-245-3400/Fax: (1) 925-960-0590

**OMRON (CHINA) CO., LTD.**

Room 2211, Bank of China Tower, 200 Yin Cheng Zhong Road,  
PuDong New Area, Shanghai, 200120, China  
Tel: (86) 21-5037-2222/Fax: (86) 21-5037-2200

**Authorized Distributor:**

© OMRON Corporation 2020 All Rights Reserved.  
In the interest of product improvement,  
specifications are subject to change without notice.

Cat. No. I837-E-13

0321 (1018)



**SCATTERGOOD  
& JOHNSON LTD**  
ELECTRICAL ENGINEERING & FLUID CONTROL DISTRIBUTORS

Est.1899

At Scattergood & Johnson Ltd, we pride ourselves on being a technical distributor to specialist industries.

Working with a range of quality product manufacturers across a number of specialist markets, we are not your average 'box shifter' - we are your technical and supply chain partner.

We fully support every product we sell - for free! Our internal team and external sales engineers can answer any product or application question, no matter the complexity.

Backing up this technical ability is a range of 50,000+ products available from stock for nationwide next day delivery (same day if required!), or you can collect what you need from any of our trade counters around the UK.

Select your specialist interest below to learn more about how we can help.

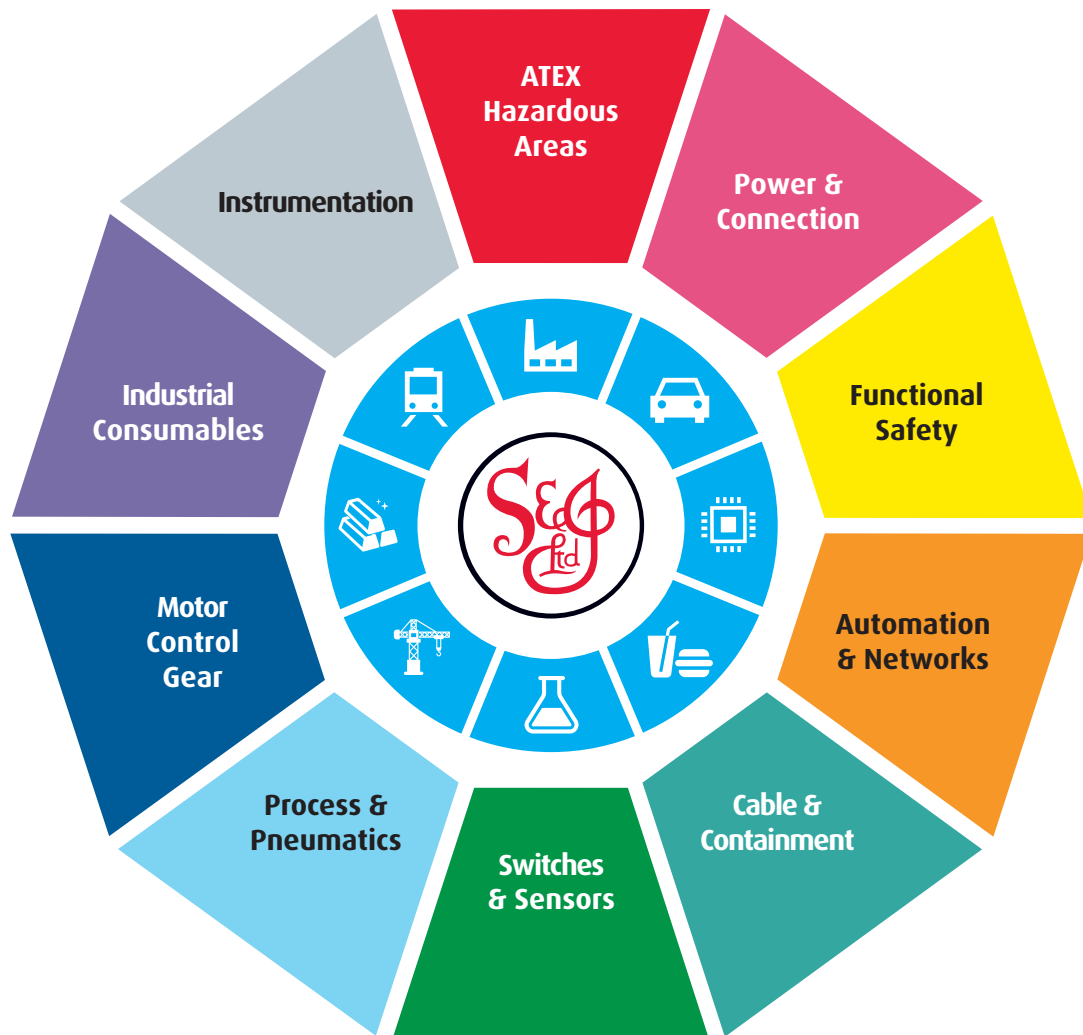

Online, In Branch and On the Road - Scattergood & Johnson Ltd, there when you need us.

**[www.scatts.co.uk](http://www.scatts.co.uk)**