



Incremental rotary encoder

ENI58IL-S

- Housing Ø 58 mm
- Solid shaft
- Servo or clamping flange
- Up to 5000 ppr
- Universal output driver
- BlueBeam technology for ultimate precision



Function

The ENI58IL impresses with its modular design, which is available over all mechanical and electrical interfaces. The ENI58IL is the best solution for all common applications, coupled with its high robustness, high reliability and versatility. With the high-precision BlueBeam technology and innovative housing design, the ENI58IL is the new market standard for incremental encoders.

Dimensions

Clamping flange

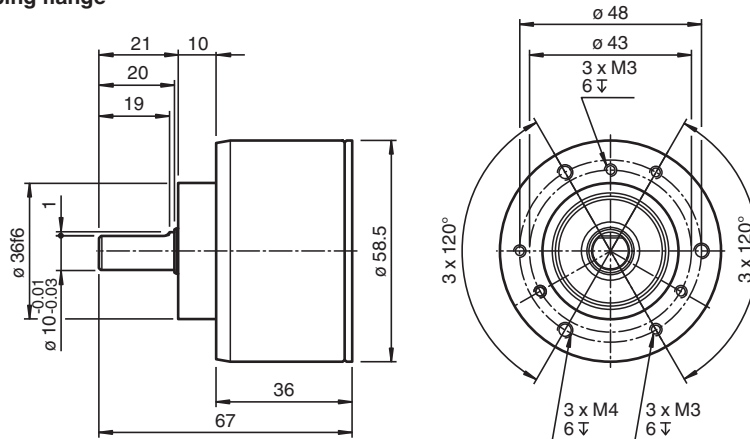

Servo flange

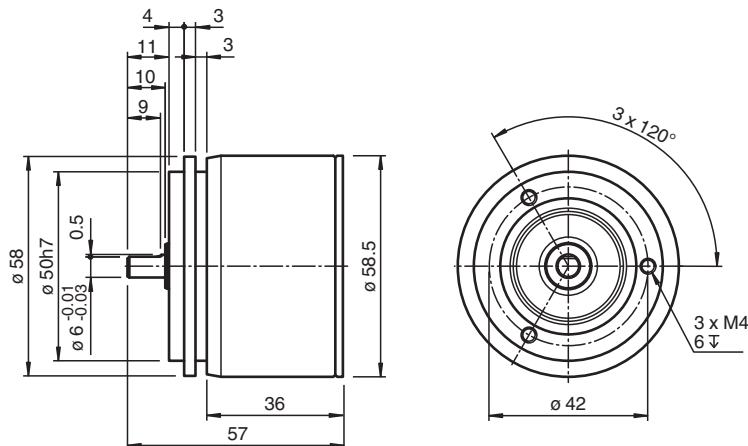

Release date: 2021-03-26 Date of issue: 2021-03-26 Filename: t182005_eng.pdf

Refer to "General Notes Relating to Pepperl+Fuchs Product Information".

Pepperl+Fuchs Group
www.pepperl-fuchs.com

USA: +1 330 486 0001
fa-info@us.pepperl-fuchs.com

Germany: +49 621 776 1111
fa-info@de.pepperl-fuchs.com

Singapore: +65 6779 9091
fa-info@sg.pepperl-fuchs.com

pf PEPPERL+FUCHS

Incremental rotary encoder

ENI58IL-S

Connections

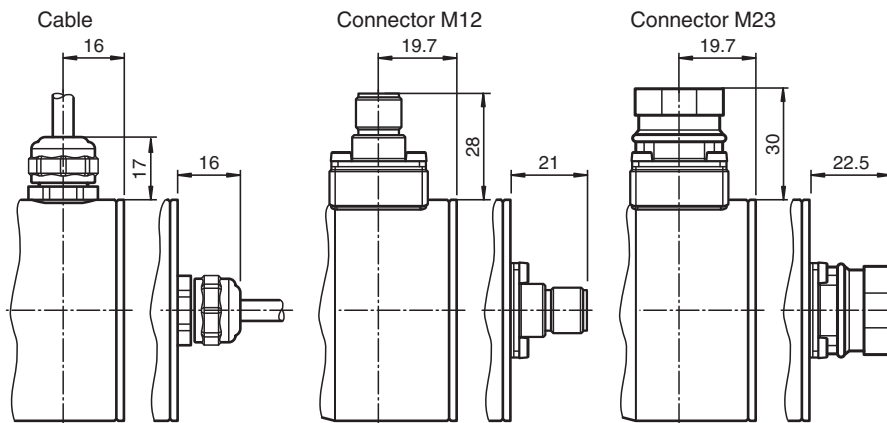

Technical Data

General specifications

Detection type	photoelectric sampling
Linearity error	$\pm 0.025^\circ$
Pulse count	max. 5000
UL File Number	E223176 "For use in NFPA 79 Applications only", if UL marking is marked on the product.

Functional safety related parameters

MTTF _d	140 a
Mission Time (T _M)	20 a
L ₁₀	70 E+9 at 6000 rpm
Diagnostic Coverage (DC)	0 %

Electrical specifications

Operating voltage	U _B	4.75 ... 30 V DC
No-load supply current	I ₀	max. 50 mA

Output

Output type	push-pull or RS422 (universal output driver, output level depending on input voltage)
Load current	max. per channel 40 mA , short-circuit protected, reverse polarity protected
Output frequency	max. 400 kHz
Rise time	300 ns
Phase position A to B	
Pulse counts < 3600	90° ± 9° electrical
Pulse counts ≥ 3600	90° ± 15° electrical
Duty cycle	1/2 ± 10 %

Connection

Connector	M12 connector, 8-pin M12 connector, 5 pin M23 connector, 12-pin
Cable	Ø6 mm, 4 x 2 x 0.14 mm ² Fixed cable with M12 plug. 5-pin Fixed cable with M12 plug. 8-pin

Standard conformity

Degree of protection	DIN EN 60529, IP65, IP67
Climatic testing	DIN EN 60068-2-78 , no moisture condensation
Emitted interference	EN 61000-6-4:2007/A1:2011
Noise immunity	EN 61000-6-2:2005
Shock resistance	DIN EN 60068-2-27, 300 g, 6 ms
Vibration resistance	DIN EN 60068-2-6, 30 g, 10 ... 2000 Hz

Approvals and certificates

UL approval	cULus Listed, General Purpose, Class 2 Power Source, Type 1 enclosure , if UL marking is marked on the product. adapters providing field wiring on request
-------------	---

Release date: 2021-03-26 Date of issue: 2021-03-26 Filename: t182005_eng.pdf

Refer to "General Notes Relating to Pepperl+Fuchs Product Information".

Pepperl+Fuchs Group
www.pepperl-fuchs.com

USA: +1 330 486 0001
fa-info@us.pepperl-fuchs.com

Germany: +49 621 776 1111
fa-info@de.pepperl-fuchs.com













Singapore: +65 6779 9091
fa-info@sg.pepperl-fuchs.com

PF PEPPERL+FUCHS

Technical Data

Maximum permissible ambient temperature	max. 80 °C (max. 176 °F)
Ambient conditions	
Operating temperature	-40 ... 85 °C (-40 ... 185 °F) , fixed cable -5 ... 85 °C (23 ... 185 °F) , movable cable
Storage temperature	-40 ... 85 °C (-40 ... 185 °F)
Mechanical specifications	
Material	
Housing	3.2315 aluminum (AlMgSi1, saltwater-proof)
Flange	3.2315 aluminum (AlMgSi1, saltwater-proof)
Shaft	Solid shaft Stainless steel
Mass	< 300 g without cable
Rotational speed	max. 12000 min ⁻¹ for IP65 , max. 6000 min ⁻¹ for IP67
Moment of inertia	≤ 35 gcm ²
Starting torque	≤ 1 Ncm for IP65 , ≤ 2.5 Ncm for IP67
Shaft load	
Axial	40 N at max. 6000 min ⁻¹ 10 N at max. 12000 min ⁻¹
Radial	80 N at max. 6000 min ⁻¹ 20 N at max. 12000 min ⁻¹

Accessories

	9416	Female cordset
	9416L	Female cordset
	MBT-36ALS	Spring-loaded mounting bracket with a diameter of 36 mm
	9203	Angled flange
	9401 10*10	Spring steel coupling
	9402 6*6	Spring steel coupling
	9404 6*6	Spring disk coupling
	9404 10*10	Spring disk coupling
	9408 10*10	Double loop coupling 10 x 10
	9409 6*6	Bellows coupling
	9409 10*10	Bellows coupling
	9410 6*6	Precision coupling

Release date: 2021-03-26 Date of issue: 2021-03-26 Filename: t182005_eng.pdf

Refer to "General Notes Relating to Pepperl+Fuchs Product Information".

 Pepperl+Fuchs Group
www.pepperl-fuchs.com









 USA: +1 330 486 0001
fa-info@us.pepperl-fuchs.com

 Germany: +49 621 776 1111
fa-info@de.pepperl-fuchs.com

 Singapore: +65 6779 9091
fa-info@sg.pepperl-fuchs.com

 **PEPPERL+FUCHS**

Accessories

	9410 10*10	Precision coupling
	V19-G-5M-PVC-TP	Female cordset, M12, 8-pin, shielded, PVC cable
	V19-G-2M-PVC-TP	Female cordset, M12, 8-pin, shielded, PVC cable
	V19-G-10M-PVC-TP	Female cordset, M12, 8-pin, shielded, PVC cable
	V19-G-BK2M-PUR-U	Female cordset single-ended M12 straight A-coded, 8-pin, PUR cable black, UL approved
	V19-G-BK5M-PUR-U	Female cordset single-ended M12 straight A-coded, 8-pin, PUR cable black, UL approved
	V19-G-BK10M-PUR-U	Female cordset single-ended M12 straight A-coded, 8-pin, PUR cable black, UL approved
	9416-*M-12P-RXI58	Female cordset, M23, 12-pin, PVC cable, 11-core

Connection

Signal	Cable	Connector M23, 12-pin, clockwise	Connector M23, 12-pin, counterclockwise	Connector M12 x 1, 8-pin	Connector M12 x 1, 5-pin
GND	White	10	10	1	3
U _b	Brown	12	12	2	1
A	Green	5	5	3	2
B	Grey	8	8	5	4
\bar{A}	Yellow	6	6	4	-
\bar{B}	Pink	1	1	6	-
Z	Blue	3	3	7	5
\bar{Z}	Red	4	4	8	-
NC	Violet	2	2	-	-
NC	Grey/Pink	7	7	-	-
NC	-	9	9	-	-
NC	Black	11	11	-	-
Shielding	Shield	Housing	Housing	Housing	Housing
	<p>Note: Unused cores must be insulated individually before commissioning in order to avoid interference.</p>				

Operation

Signal outputs

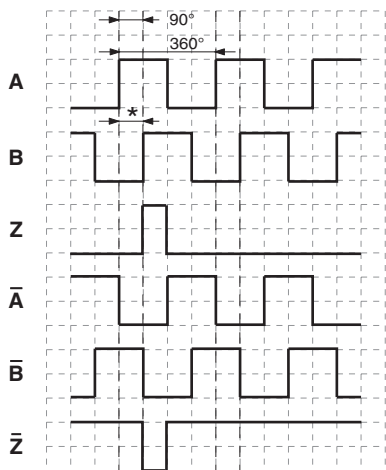

↺ cw - with view onto the shaft
phase relationships electrical
* 1 Measuring step is 90° electrical

Type Code

Release date: 2021-03-26 Date of issue: 2021-03-26 Filename: t182005_eng.pdf

Incremental rotary encoder

ENI58IL-S



Connection type

B2 Fixed cable with M12 plug, 8-pin, 1 m

B4 Fixed cable with M12 plug, 5-pin, 1 m

C1 Cable, 1 m

C2 Cable, 2 m

C5 Cable, 5 m

CA Cable, 10 m

AA M23 device plug, clockwise (type 9416)

AB M23 device plug, counterclockwise (type 9416L)

BE M12 device plug, 8-pin (type V19)

BD M12 device plug, 5-pin (type V15)

Connection alignment

A axial

R radial

Electrical interface

UD1 Universal output driver UB 5 V ... 30 V

UD2 RS422, U_B 5 V ... 30 V

Pulse count

0100, 0120, 0125, 0200, 0256, **0360**, 0500, **1000**, **1024**, 1250, 1500, 1800, 2000, **2048**, **2500**, 3600, 4000, **4096**, **5000**

Degree of protection

5 **IP65**

7 IP67

Flange

CA Clamping flange

SA Servo flange

Shaft diameter

06 6 x 10 mm

08 8 x 20 mm

10 10 x 20 mm

12 12 x 20 mm

Shaft type

S Solid shaft

Version

IL Industrial Line

Size

58 Housing diameter 58 mm

Device type

ENI Incremental rotary encoder

Note: Preferred options are in bold letters.

Release date: 2021-03-26 Date of issue: 2021-03-26 Filename: t182005_eng.pdf



**SCATTERGOOD
& JOHNSON LTD**
ELECTRICAL ENGINEERING & FLUID CONTROL DISTRIBUTORS

Est.1899

At Scattergood & Johnson Ltd, we pride ourselves on being a technical distributor to specialist industries.

Working with a range of quality product manufacturers across a number of specialist markets, we are not your average 'box shifter' - we are your technical and supply chain partner.

We fully support every product we sell - for free! Our internal team and external sales engineers can answer any product or application question, no matter the complexity.

Backing up this technical ability is a range of 50,000+ products available from stock for nationwide next day delivery (same day if required!), or you can collect what you need from any of our trade counters around the UK.

Select your specialist interest below to learn more about how we can help.



Online, In Branch and On the Road - Scattergood & Johnson Ltd, there when you need us.

www.scatts.co.uk