



LED Indicators

## Semaphore

Series CR

## Position

Series PI



## Series CR and PI

## Technical features

Body material:	<b>Polycarbonate (PC) V0/UL 94</b>
Body colour:	<b>Black</b>
Protection degree:	<b>IP54</b>
Working temperature:	<b>20°C +60°C</b>
Operating life at AT 25°C:	<b>&gt; 100.000 h</b>
<b>Not replaceable LEDs</b>	



### Supply voltage +/- 10%

Power	Consumption	Current
24 Vac/dc	15-20mA	AC/DC
48 Vac/dc	15-20mA	AC/DC
130 = 110-130 Vac/dc	15-20mA	AC/DC
240 Vac	15mA	Alternating Current
220 Vdc	9mA	Direct Current

Other power supplies on request



Available with integrated Lamp Test circuit (LT), to test all signals at once.



Integrated Rectifier Bridge to work in Alternating Current (AC) or Direct Current (DC), automatically.



Available with Inbuilt Diode (PD) to avoid reverse feeding. Also is possible choose the Positive Common, Negative Common or Not Polarized options.

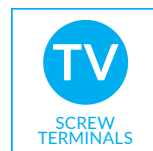

Easy to connect thanks to the Faston terminals 2.8mm x 0.8mm, Screw terminals or Flying Leads.

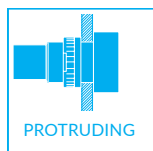
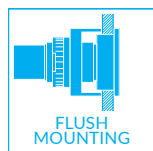

B type solution with low-profile Flush Mounting, to limit the external dimensions and improve the design of the panel.

Compliance:

**Directive 2006/95/EC Low Voltage**  
**Directive 2004/108/EC Electromagnetic Compatibility**  
**Directive 2011/65/EC RhOS**  
**Directive 2006/42/EC Machinery**

Conformity to standards:

**EN 60947.5.1 / EN 60073 / EN 60529 / EN 60068-2-6 / EN 60204.1 / EN ISO 7731 / EN 981 / IEC 536**

Customs tariff: **85389091**

DOMO reserves the right to change, amend, modify, suspend, continue or terminate all or any part of the Product range either in an individual case or in general, at any time without notice.

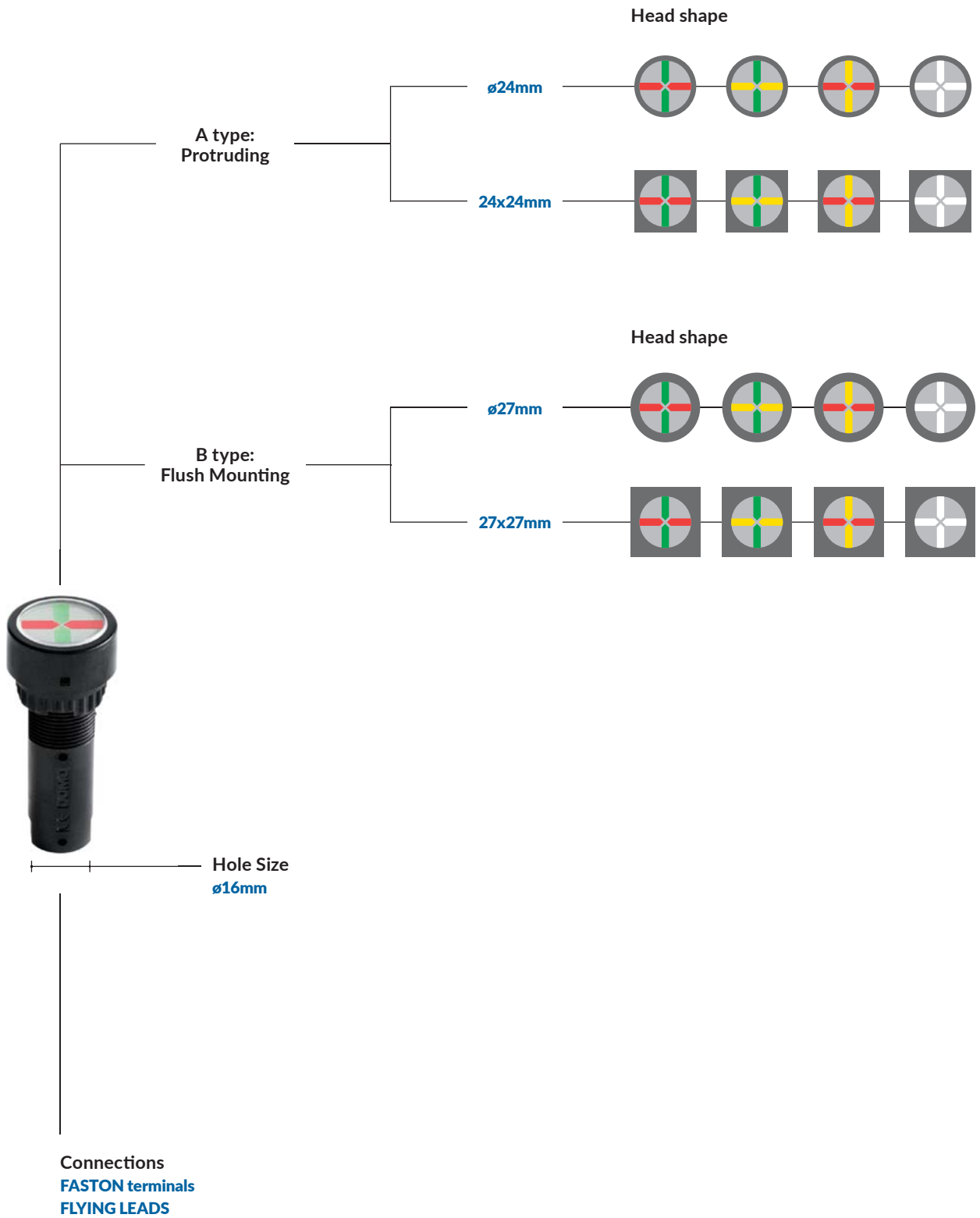

# Series CR - ø16mm

## Coding

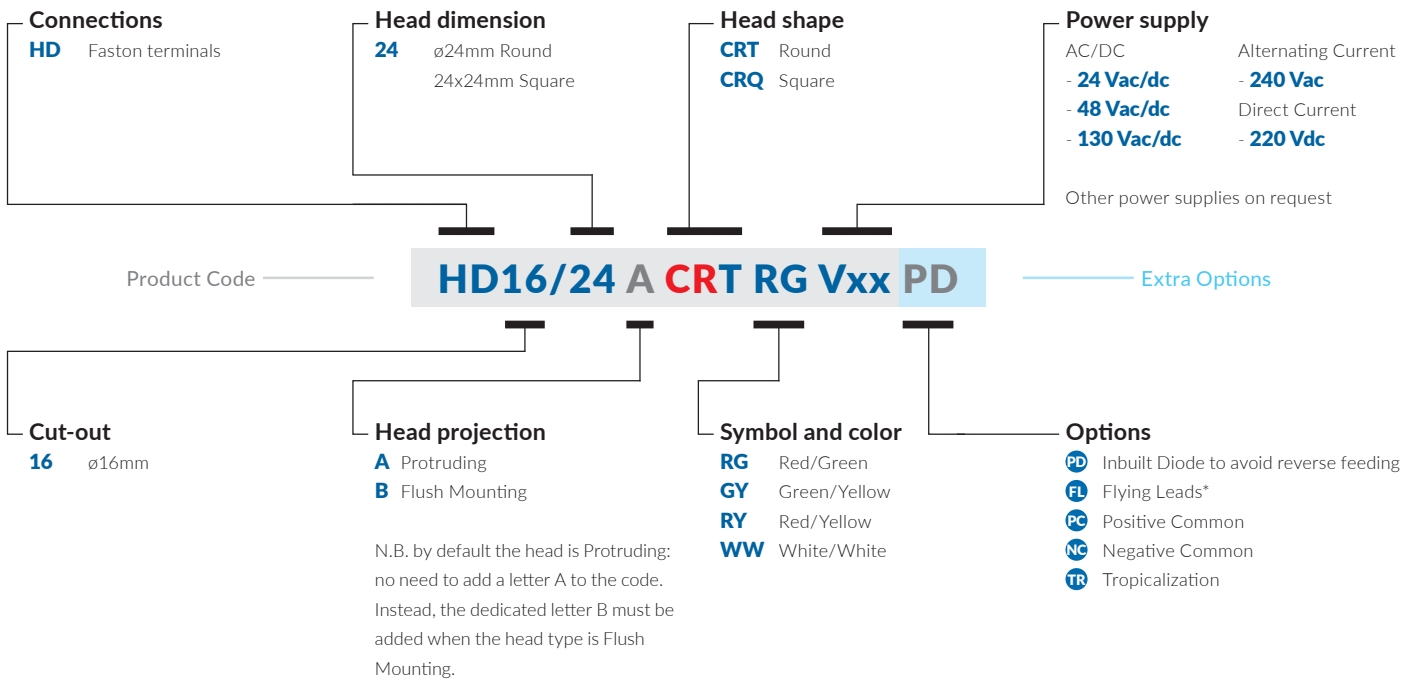

Please see product range section for the feasibility. Special version on request.

\* Please contact our sales office to define details.



# Series PI - $\varnothing 16\text{mm}$

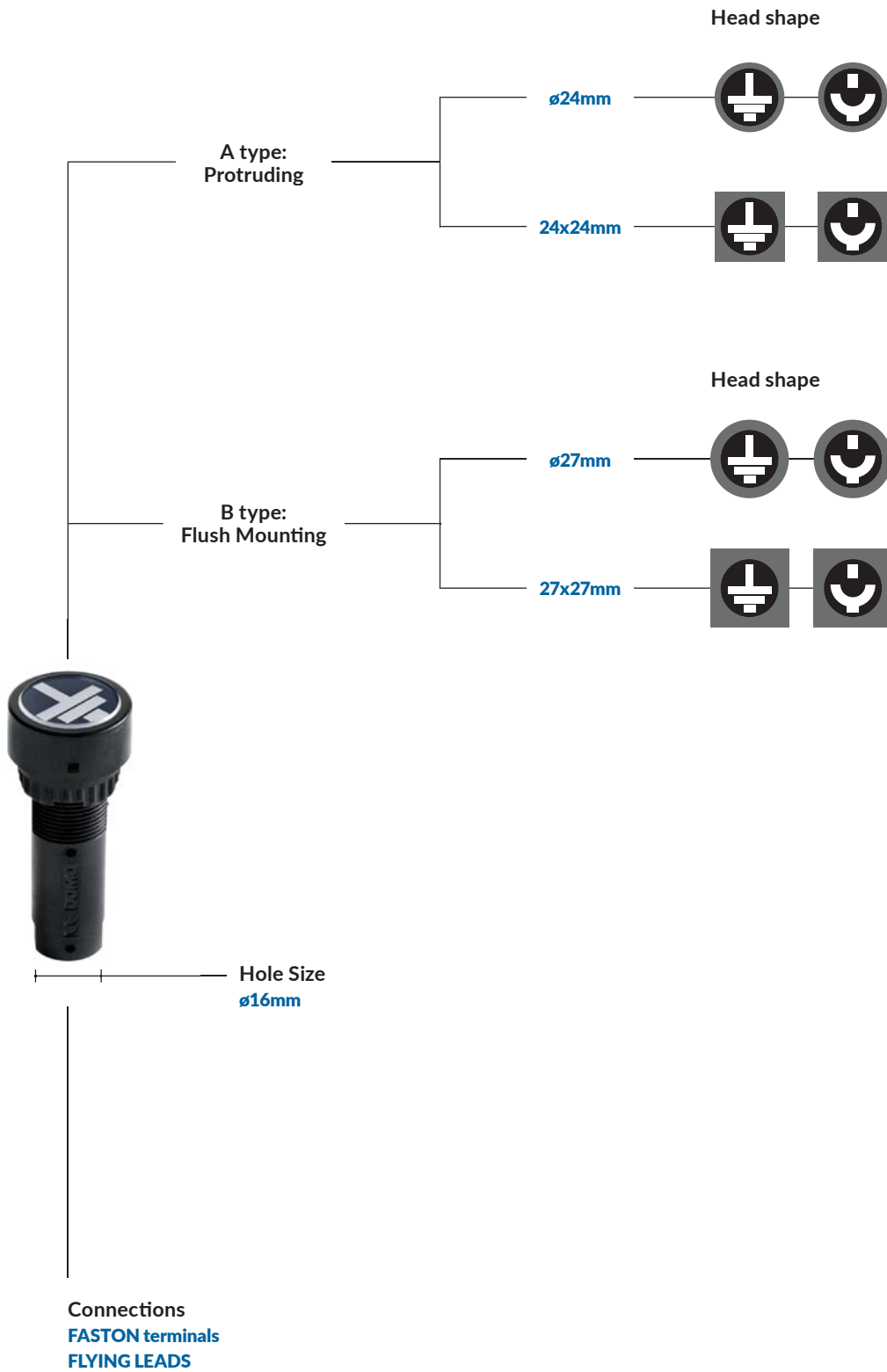

# Series PI - ø16mm

## Coding

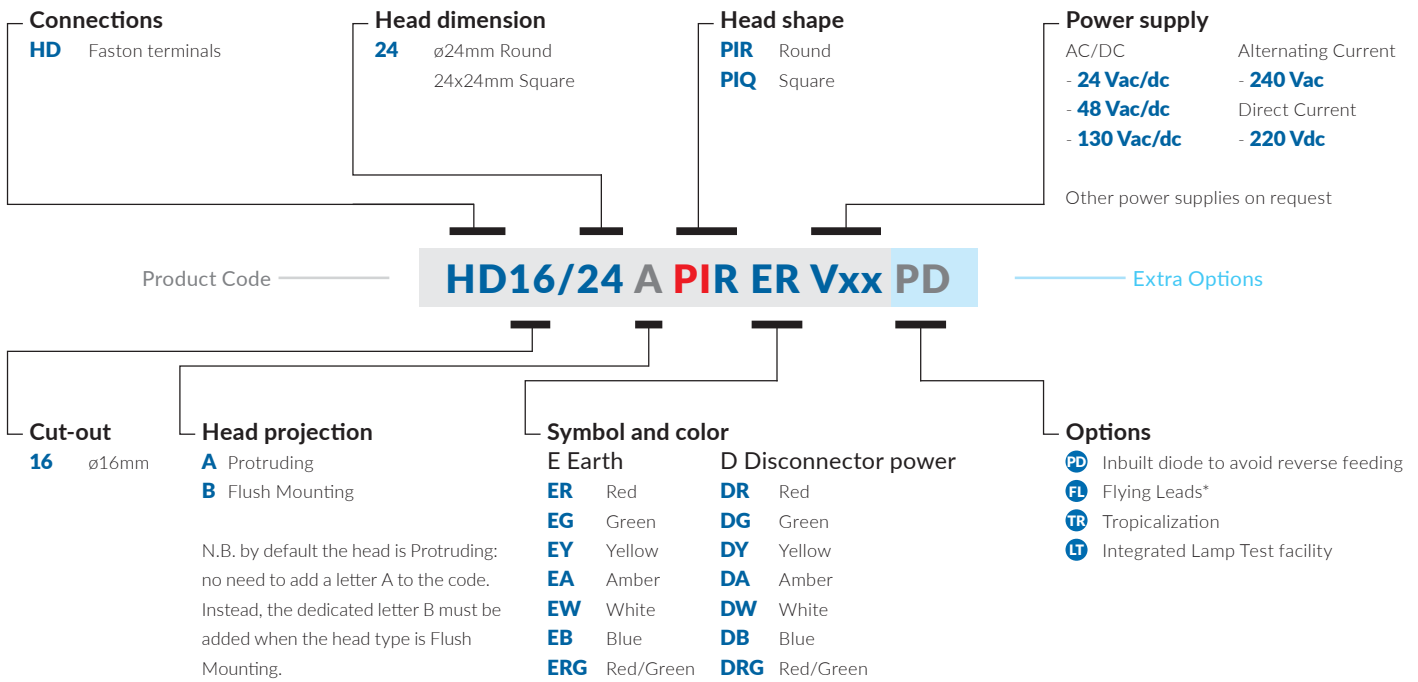

Please see product range section for the feasibility. Special version on request.

\* Please contact our sales office to define details.



# Series CR and PI - Ø16mm

# Product range

**A type**  
Protruding  
Head Ø24mm  
Cut-out Ø16mm  
Weight 13g



**B type**  
Flush Mounting  
Head Ø27mm  
Cut-out Ø24mm  
Weight 16g



**A type**  
Protruding  
Head 24x24mm  
Cut-out Ø16mm  
Weight 13g



**B type**  
Flush Mounting  
Head 27x27mm  
Cut-out 24x24mm  
Weight 16g

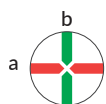

a Red  
b Green

HD16/24 CRT RG Vxx

PD FL PC NC TR

HD16/24B CRT RG Vxx

PD FL PC NC TR

HD16/24 CRQ RG Vxx

PD FL PC NC TR

HD16/24B CRQ RG Vxx

PD FL PC NC TR

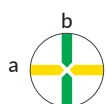

a Yellow  
b Green

HD16/24 CRT GY Vxx

PD FL PC NC TR

HD16/24B CRT GY Vxx

PD FL PC NC TR

HD16/24 CRQ GY Vxx

PD FL PC NC TR

HD16/24B CRQ GY Vxx

PD FL PC NC TR



a Red  
b Yellow

HD16/24 CRT RG Vxx

PD FL PC NC TR

HD16/24B CRT RG Vxx

PD FL PC NC TR

HD16/24 CRQ RG Vxx

PD FL PC NC TR

HD16/24B CRQ RG Vxx

PD FL PC NC TR

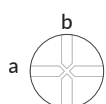

a White  
b White

HD16/24 CRT WW Vxx

PD FL PC NC TR

HD16/24B CRT WW Vxx

PD FL PC NC TR

HD16/24 CRQ WW Vxx

PD FL PC NC TR

HD16/24B CRQ WW Vxx

PD FL PC NC TR



- Red
- Green
- Yellow
- Amber
- Blue
- White

HD16/24 PIR ER Vxx

PD FL TR LT

HD16/24B PIR ER Vxx

PD FL TR LT

HD16/24 PIQ ER Vxx

PD FL TR LT

HD16/24B PIQ ER Vxx

PD FL TR LT

HD16/24 PIR EG Vxx

PD FL TR LT

HD16/24B PIR EG Vxx

PD FL TR LT

HD16/24 PIQ EG Vxx

PD FL TR LT

HD16/24B PIQ EG Vxx

PD FL TR LT

HD16/24 PIR EY Vxx

PD FL TR LT

HD16/24B PIR EY Vxx

PD FL TR LT

HD16/24 PIQ EY Vxx

PD FL TR LT

HD16/24B PIQ EY Vxx

PD FL TR LT

HD16/24 PIR EA Vxx

PD FL TR LT

HD16/24B PIR EA Vxx

PD FL TR LT

HD16/24 PIQ EA Vxx

PD FL TR LT

HD16/24B PIQ EA Vxx

PD FL TR LT

HD16/24 PIR EB Vxx

PD FL TR LT

HD16/24B PIR EB Vxx

PD FL TR LT

HD16/24 PIQ EB Vxx

PD FL TR LT

HD16/24B PIQ EB Vxx

PD FL TR LT

HD16/24 PIR EW Vxx

PD FL TR LT

HD16/24B PIR EW Vxx

PD FL TR LT

HD16/24 PIQ EW Vxx

PD FL TR LT

HD16/24B PIQ EW Vxx

PD FL TR LT

● Red/Green

HD16/24 PIR ERG Vxx

PD FL TR

HD16/24B PIR ERG Vxx

PD FL TR

HD16/24 PIQ ERG Vxx

PD FL TR

HD16/24B PIQ ERG Vxx

PD FL TR



- Red
- Green
- Yellow
- Amber
- Blue
- White

HD16/24 PIR DR Vxx

PD FL TR LT

HD16/24B PIR DR Vxx

PD FL TR LT

HD16/24 PIQ DR Vxx

PD FL TR LT

HD16/24B PIQ DR Vxx

PD FL TR LT

HD16/24 PIR DG Vxx

PD FL TR LT

HD16/24B PIR DG Vxx

PD FL TR LT

HD16/24 PIQ DG Vxx

PD FL TR LT

HD16/24B PIQ DG Vxx

PD FL TR LT

HD16/24 PIR DY Vxx

PD FL TR LT

HD16/24B PIR DY Vxx

PD FL TR LT

HD16/24 PIQ DY Vxx

PD FL TR LT

HD16/24B PIQ DY Vxx

PD FL TR LT

HD16/24 PIR DA Vxx

PD FL TR LT

HD16/24B PIR DA Vxx

PD FL TR LT

HD16/24 PIQ DA Vxx

PD FL TR LT

HD16/24B PIQ DA Vxx

PD FL TR LT

HD16/24 PIR DB Vxx

PD FL TR LT

HD16/24B PIR DB Vxx

PD FL TR LT

HD16/24 PIQ DB Vxx

PD FL TR LT

HD16/24B PIQ DB Vxx

PD FL TR LT

HD16/24 PIR DW Vxx

PD FL TR

HD16/24B PIR DW Vxx

PD FL TR

HD16/24 PIQ DW Vxx

PD FL TR

HD16/24B PIQ DW Vxx

PD FL TR

● Red/Green

HD16/24 PIR DRG Vxx

PD FL TR

HD16/24B PIR DRG Vxx

PD FL TR

HD16/24 PIQ DRG Vxx

PD FL TR

HD16/24B PIQ DRG Vxx

PD FL TR

# Series CR and PI - $\varnothing 16\text{mm}$

# Dimensions and wiring

## HD16/24 CR - Semaphore

Dimensions mm 1:2

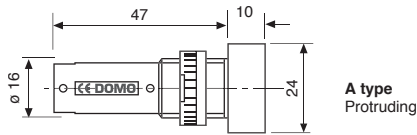

board thickness 10 mm  
clamping: threaded nut

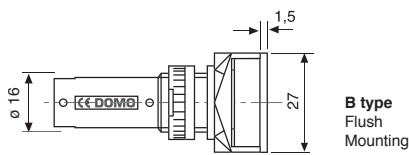

board thickness 1 mm  
clamping: threaded nut

### Faston terminals Tabs 2,8 x 0,8mm

#### Bicolor

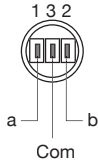

### Flying Leads

#### Bicolor



## HD16/24 PI - Position

Dimensions mm 1:2

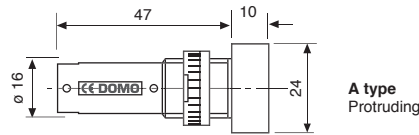

board thickness 10 mm  
clamping: threaded nut

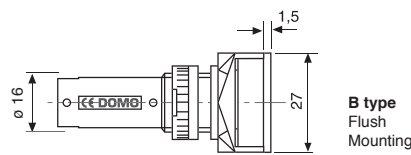

board thickness 1 mm  
clamping: threaded nut

### Faston terminals Tabs 2,8 x 0,8mm

#### Monocolor

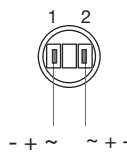

#### Bicolor

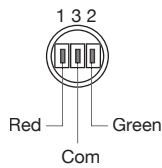

### Flying Leads

#### Monocolor

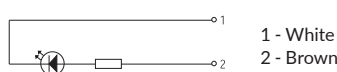

#### Bicolor

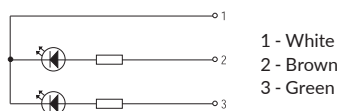

#### Monocolor + Lamp Test (LT)

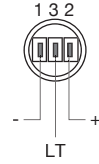

#### Monocolor + Lamp Test (LT)

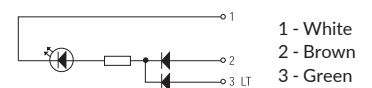

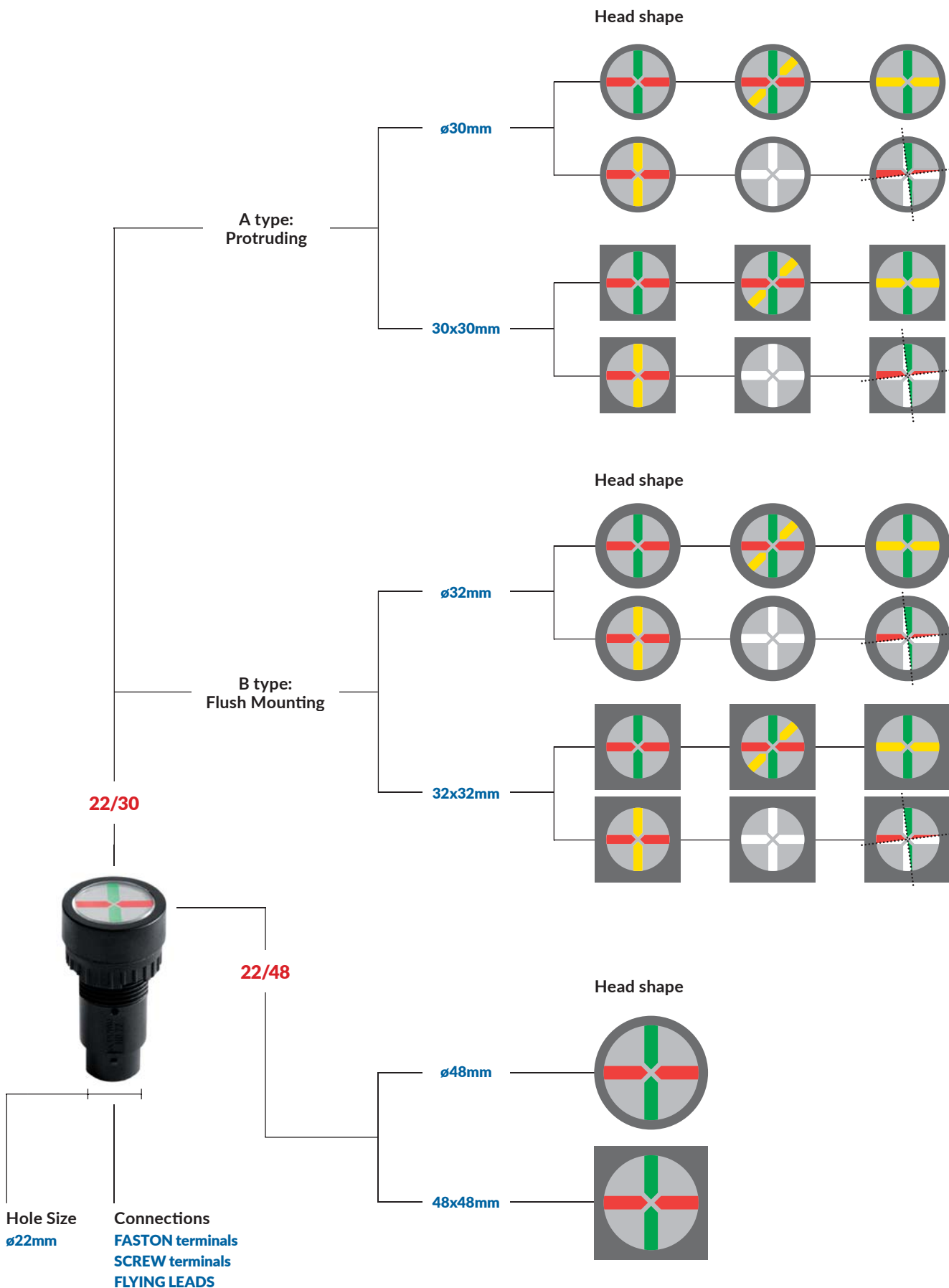

# Series CR - ø22mm

## Coding

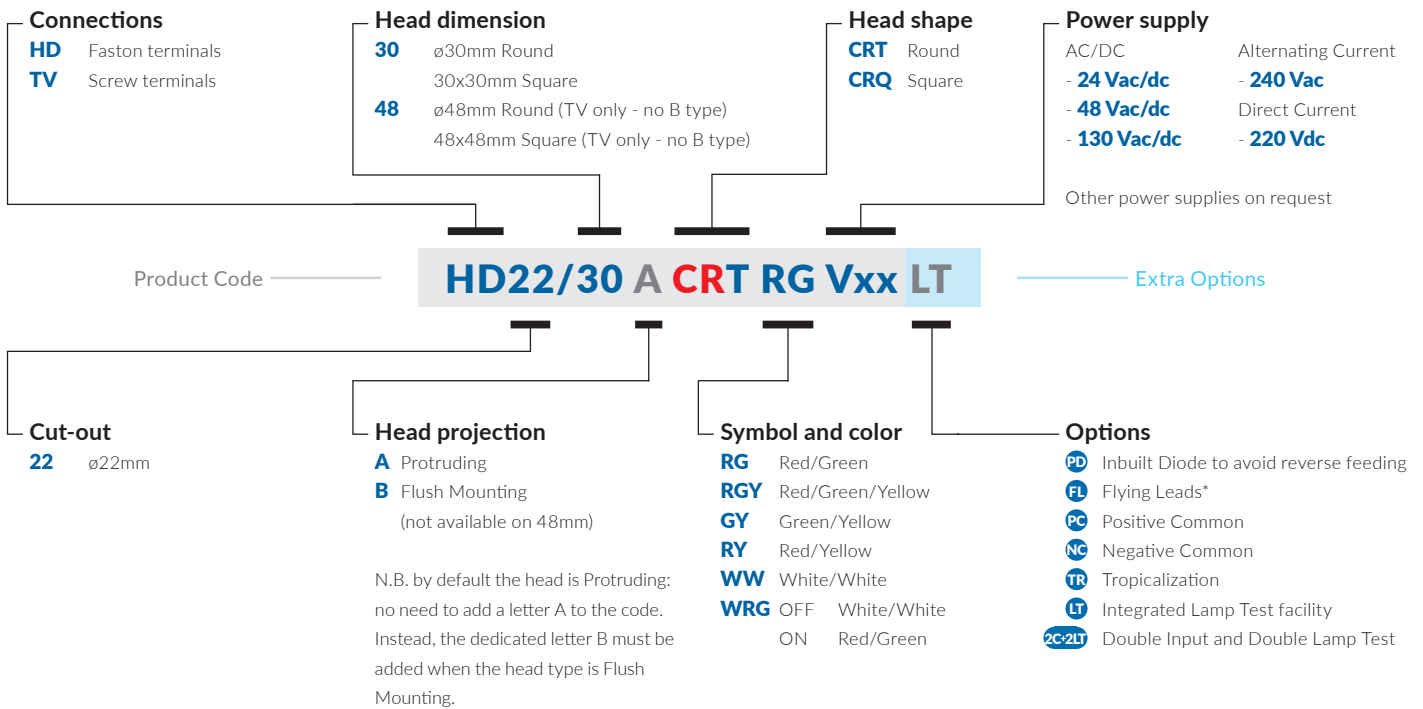

Please see product range section for the feasibility. Special version on request.

\* Please contact our sales office to define details.

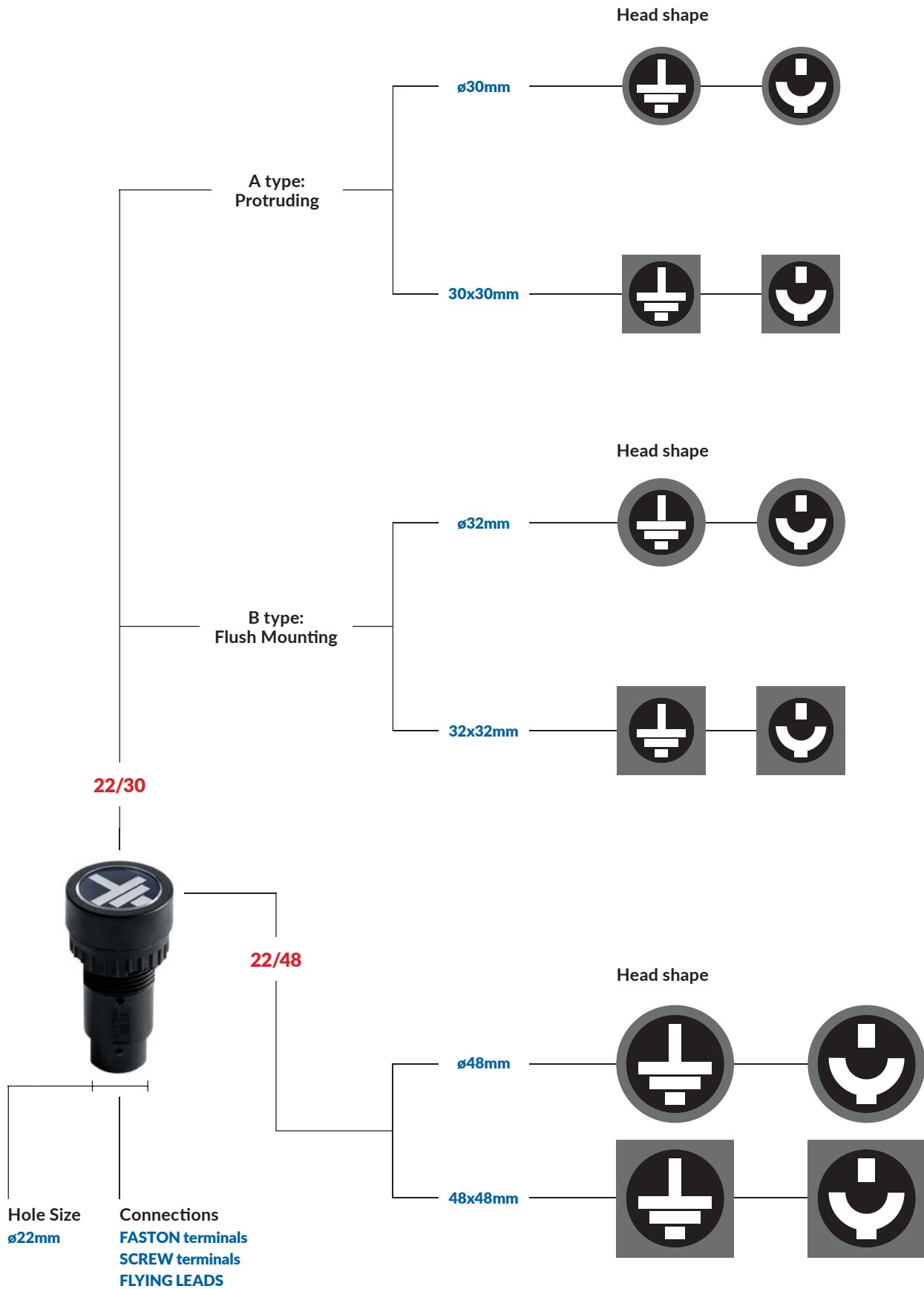

# Series PI - ø22mm

## Coding

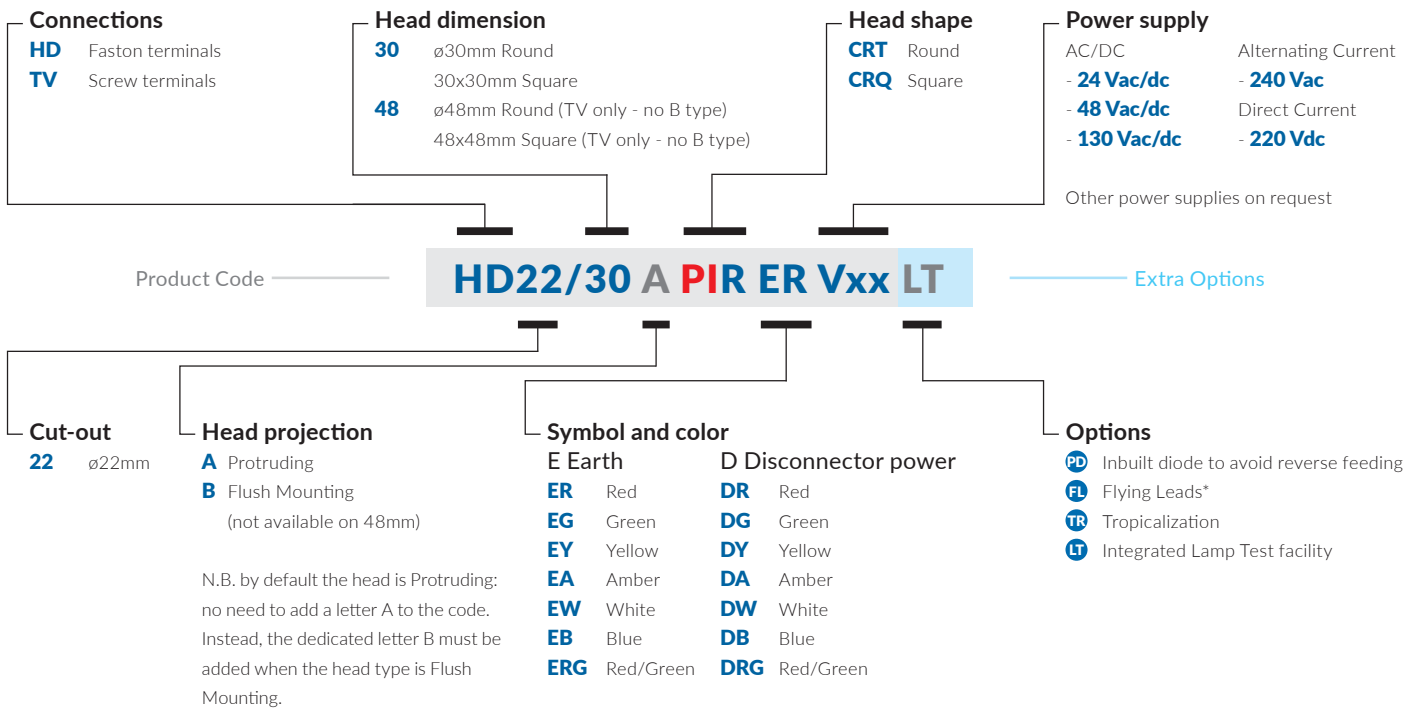

Please see product range section for the feasibility. Special version on request.

\* Please contact our sales office to define details.



Series CR - Ø22mm

Product range

**A type**  
Protruding  
Head Ø30mm  
Cut-out Ø22mm  
Weight 18g

**B type**  
Flush Mounting  
Head Ø32mm  
Cut-out Ø30mm  
Weight 21g

**A type**  
Protruding  
Head 30x30mm  
Cut-out Ø22mm  
Weight 19g

**B type**  
Flush Mounting  
Head 32x32mm  
Cut-out 30x30mm  
Weight 22g

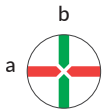

a Red  
b Green

HD22/30 CRT RG Vxx

PD PC NC TR LT 2C-2LT

HD22/30B CRT RG Vxx

PD PC NC TR LT 2C-2LT

HD22/30 CRQ RG Vxx

PD PC NC TR LT 2C-2LT

HD22/30B CRQ RG Vxx

PD PC NC TR LT 2C-2LT

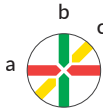

a Red  
b Green  
c Yellow

HD22/30 CRT RGY Vxx

PD PC NC TR LT

HD22/30B CRT RGY Vxx

PD PC NC TR LT

HD22/30 CRQ RGY Vxx

PD PC NC TR LT

HD22/30B CRQ RGY Vxx

PD PC NC TR LT

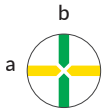

a Yellow  
b Green

HD22/30 CRT GY Vxx

PD PC NC TR LT 2C-2LT

HD22/30B CRT GY Vxx

PD PC NC TR LT 2C-2LT

HD22/30 CRQ GY Vxx

PD PC NC TR LT 2C-2LT

HD22/30B CRQ GY Vxx

PD PC NC TR LT 2C-2LT

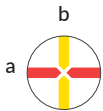

a Red  
b Yellow

HD22/30 CRT RY Vxx

PD PC NC TR LT 2C-2LT

HD22/30B CRT RY Vxx

PD PC NC TR LT 2C-2LT

HD22/30 CRQ RY Vxx

PD PC NC TR LT 2C-2LT

HD22/30B CRQ RY Vxx

PD PC NC TR LT 2C-2LT

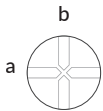

a White  
b White

HD22/30 CRT WW Vxx

PD PC NC TR LT 2C-2LT

HD22/30B CRT WW Vxx

PD PC NC TR LT 2C-2LT

HD22/30 CRQ WW Vxx

PD PC NC TR LT 2C-2LT

HD22/30B CRQ WW Vxx

PD PC NC TR LT 2C-2LT

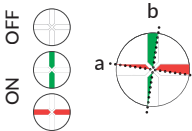

a White/Red  
b White/Green

HD22/30 CRT WRG Vxx

PD PC NC TR LT 2C-2LT

HD22/30B CRT WRG Vxx

PD PC NC TR LT 2C-2LT

HD22/30 CRQ WRG Vxx

PD PC NC TR LT 2C-2LT

HD22/30B CRQ WRG Vxx

PD PC NC TR LT 2C-2LT

# Series PI - Ø22mm

# Product range

**A type**  
 Protruding  
 Head Ø30mm  
 Cut-out Ø22mm  
 Weight 16g



**B type**  
 Flush Mounting  
 Head Ø32mm  
 Cut-out Ø30mm  
 Weight 20g



**A type**  
 Protruding  
 Head 30x30mm  
 Cut-out Ø22mm  
 Weight 18g



**B type**  
 Flush Mounting  
 Head 32x32mm  
 Cut-out 30x30mm  
 Weight 21g



● Red	HD22/30 PIR ER Vxx	HD22/30B PIR ER Vxx	HD22/30 PIQ ER Vxx	HD22/30B PIQ ER Vxx
● Green	HD22/30 PIR EG Vxx	HD22/30B PIR EG Vxx	HD22/30 PIQ EG Vxx	HD22/30B PIQ EG Vxx
● Yellow	HD22/30 PIR EY Vxx	HD22/30B PIR EY Vxx	HD22/30 PIQ EY Vxx	HD22/30B PIQ EY Vxx
● Amber	HD22/30 PIR EA Vxx	HD22/30B PIR EA Vxx	HD22/30 PIQ EA Vxx	HD22/30B PIQ EA Vxx
● Blue	HD22/30 PIR EB Vxx	HD22/30B PIR EB Vxx	HD22/30 PIQ EB Vxx	HD22/30B PIQ EB Vxx
○ White	HD22/30 PIR EW Vxx	HD22/30B PIR EW Vxx	HD22/30 PIQ EW Vxx	HD22/30B PIQ EW Vxx
	PD TR LT	PD TR LT	PD TR LT	PD TR LT

● Red/Green	HD22/30 PIR ERG Vxx	HD22/30B PIR ERG Vxx	HD22/30 PIQ ERG Vxx	HD22/30B PIQ ERG Vxx
	PD TR	PD TR	PD TR	PD TR



● Red	HD22/30 PIR DR Vxx	HD22/30B PIR DR Vxx	HD22/30 PIQ DR Vxx	HD22/30B PIQ DR Vxx
● Green	HD22/30 PIR DG Vxx	HD22/30B PIR DG Vxx	HD22/30 PIQ DG Vxx	HD22/30B PIQ DG Vxx
● Yellow	HD22/30 PIR DY Vxx	HD22/30B PIR DY Vxx	HD22/30 PIQ DY Vxx	HD22/30B PIQ DY Vxx
● Amber	HD22/30 PIR DA Vxx	HD22/30B PIR DA Vxx	HD22/30 PIQ DA Vxx	HD22/30B PIQ DA Vxx
● Blue	HD22/30 PIR DB Vxx	HD22/30B PIR DB Vxx	HD22/30 PIQ DB Vxx	HD22/30B PIQ DB Vxx
○ White	HD22/30 PIR DW Vxx	HD22/30B PIR DW Vxx	HD22/30 PIQ DW Vxx	HD22/30B PIQ DW Vxx
	PD TR LT	PD TR LT	PD TR LT	PD TR LT

● Red/Green	HD22/30 PIR DRG Vxx	HD22/30B PIR DRG Vxx	HD22/30 PIQ DRG Vxx	HD22/30B PIQ DRG Vxx
	PD TR	PD TR	PD TR	PD TR



HD22/30 CR

Dimensions mm 1:2

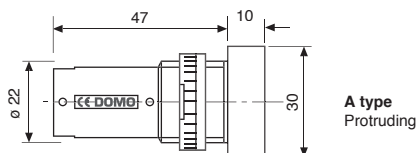

board thickness 10 mm  
clamping: threaded nut

Dimensions mm 1:2

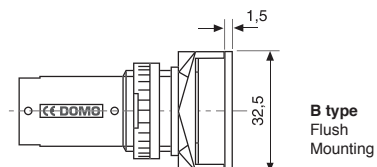

board thickness 1 mm  
clamping: threaded nut

Faston terminals Tabs 2,8 x 0,8mm

Bicolor

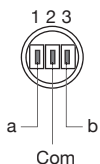

Bicolor + Lamp Test (LT)

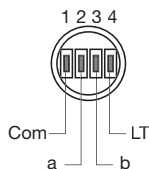

Tricolor

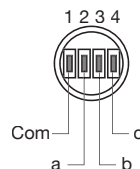

Tricolor + Lamp Test (LT)

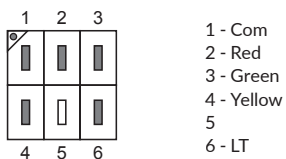

Double Input (2C) + Double Lamp Test (2LT)

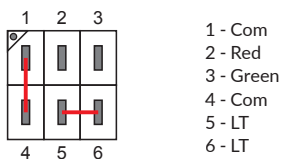

# Series PI - $\varnothing 22\text{mm}$

# Dimensions and wiring

## HD22/30 PI

Dimensions mm 1:2

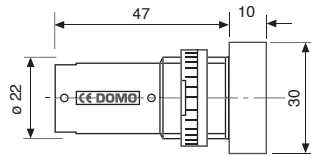

**A type**  
Protruding

board thickness 10 mm  
clamping: threaded nut

Dimensions mm 1:2

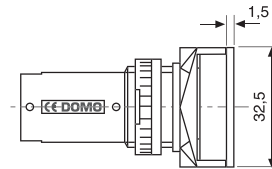

**B type**  
Flush  
Mounting

board thickness 1 mm  
clamping: threaded nut

## Faston terminals Tabs 2,8 x 0,8mm

Monocolor

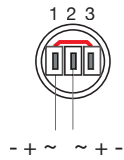

Monocolor + Lamp Test (LT)

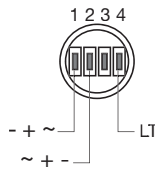

Bicolor

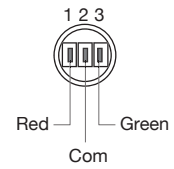



# Series CR - Ø22mm

# Product range

**A type**  
Protruding  
Head Ø30mm  
Cut-out Ø22mm  
Weight 21g

**B type**  
Flush Mounting  
Head Ø32mm  
Cut-out Ø30mm  
Weight 25g

**A type**  
Protruding  
Head 30x30mm  
Cut-out Ø22mm  
Weight 22g

**B type**  
Flush Mounting  
Head 32x32mm  
Cut-out 30x30mm  
Weight 26g

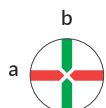

a Red  
b Green

TV22/30 CRT RG Vxx

PD FL PC NC TR LT 2C-2LT

TV22/30B CRT RG Vxx

PD FL PC NC TR LT 2C-2LT

TV22/30 CRQ RG Vxx

PD FL PC NC TR LT 2C-2LT

TV22/30B CRQ RG Vxx

PD FL PC NC TR LT 2C-2LT



a Red  
b Green  
c Yellow

TV22/30 CRT RGY Vxx

PD FL PD PC NC TR LT

TV22/30B CRT RGY Vxx

PD FL PC NC TR LT

TV22/30 CRQ RGY Vxx

PD FL PC NC TR LT

TV22/30B CRQ RGY Vxx

PD FL PC NC TR LT

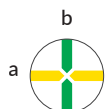

a Yellow  
b Green

TV22/30 CRT GY Vxx

PD FL PC NC TR LT 2C-2LT

TV22/30B CRT GY Vxx

PD FL PC NC TR LT 2C-2LT

TV22/30 CRQ GY Vxx

PD FL PC NC TR LT 2C-2LT

TV22/30B CRQ GY Vxx

PD FL PC NC TR LT 2C-2LT



a Red  
b Yellow

TV22/30 CRT RY Vxx

PD FL PC NC TR LT 2C-2LT

TV22/30B CRT RY Vxx

PD FL PC NC TR LT 2C-2LT

TV22/30 CRQ RY Vxx

PD FL PC NC TR LT 2C-2LT

TV22/30B CRQ RY Vxx

PD FL PC NC TR LT 2C-2LT

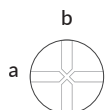

a White  
b White

TV22/30 CRT WW Vxx

PD FL PC NC TR LT 2C-2LT

TV22/30B CRT WW Vxx

PD FL PC NC TR LT 2C-2LT

TV22/30 CRQ WW Vxx

PD FL PC NC TR LT 2C-2LT

TV22/30B CRQ WW Vxx

PD FL PC NC TR LT 2C-2LT

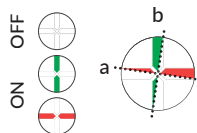

a White/Red  
b White/Green

TV22/30 CRT WRG Vxx

PD FL PC NC TR LT 2C-2LT

TV22/30B CRT WRG Vxx

PD FL PC NC TR LT 2C-2LT

TV22/30 CRQ WRG Vxx

PD FL PC NC TR LT 2C-2LT

TV22/30B CRQ WRG Vxx

PD FL PC NC TR LT 2C-2LT

# Series PI - Ø22mm

# Product range

**A type**  
Protruding  
Head Ø30mm  
Cut-out Ø22mm  
Weight 19g



**B type**  
Flush Mounting  
Head Ø32mm  
Cut-out Ø30mm  
Weight 24g



**A type**  
Protruding  
Head 30x30mm  
Cut-out Ø22mm  
Weight 21g



**B type**  
Flush Mounting  
Head 32x32mm  
Cut-out 30x30mm  
Weight 25g



● Red	TV22/30 PIR ER Vxx	TV22/30B PIR ER Vxx	TV22/30 PIQ ER Vxx	TV22/30B PIQ ER Vxx
● Green	TV22/30 PIR EG Vxx	TV22/30B PIR EG Vxx	TV22/30 PIQ EG Vxx	TV22/30B PIQ EG Vxx
● Yellow	TV22/30 PIR EY Vxx	TV22/30B PIR EY Vxx	TV22/30 PIQ EY Vxx	TV22/30B PIQ EY Vxx
● Amber	TV22/30 PIR EA Vxx	TV22/30B PIR EA Vxx	TV22/30 PIQ EA Vxx	TV22/30B PIQ EA Vxx
● Blue	TV22/30 PIR EB Vxx	TV22/30B PIR EB Vxx	TV22/30 PIQ EB Vxx	TV22/30B PIQ EB Vxx
○ White	TV22/30 PIR EW Vxx	TV22/30B PIR EW Vxx	TV22/30 PIQ EW Vxx	TV22/30B PIQ EW Vxx

PD FL TR LT

PD FL TR LT

PD FL TR LT

PD FL TR LT

● Red/Green	TV22/30 PIR ERG Vxx	TV22/30B PIR ERG Vxx	TV22/30 PIQ ERG Vxx	TV22/30B PIQ ERG Vxx
-------------	---------------------	----------------------	---------------------	----------------------

PD FL TR

PD FL TR

PD FL TR

PD FL TR



● Red	TV22/30 PIR DR Vxx	TV22/30B PIR DR Vxx	TV22/30 PIQ DR Vxx	TV22/30B PIQ DR Vxx
● Green	TV22/30 PIR DG Vxx	TV22/30B PIR DG Vxx	TV22/30 PIQ DG Vxx	TV22/30B PIQ DG Vxx
● Yellow	TV22/30 PIR DY Vxx	TV22/30B PIR DY Vxx	TV22/30 PIQ DY Vxx	TV22/30B PIQ DY Vxx
● Amber	TV22/30 PIR DA Vxx	TV22/30B PIR DA Vxx	TV22/30 PIQ DA Vxx	TV22/30B PIQ DA Vxx
● Blue	TV22/30 PIR DB Vxx	TV22/30B PIR DB Vxx	TV22/30 PIQ DB Vxx	TV22/30B PIQ DB Vxx
○ White	TV22/30 PIR DW Vxx	TV22/30B PIR DW Vxx	TV22/30 PIQ DW Vxx	TV22/30B PIQ DW Vxx

PD FL TR LT

PD FL TR LT

PD FL TR LT

PD FL TR LT

● Red/Green	TV22/30 PIR DRG Vxx	TV22/30B PIR DRG Vxx	TV22/30 PIQ DRG Vxx	TV22/30B PIQ DRG Vxx
-------------	---------------------	----------------------	---------------------	----------------------

PD FL TR

PD FL TR

PD FL TR

PD FL TR



TV22/30 CR

Dimensions mm 1:2

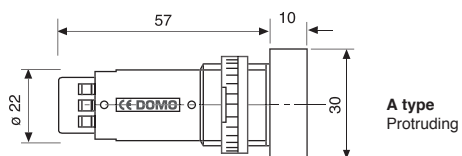

board thickness 10 mm  
clamping: threaded nut

Dimensions mm 1:2

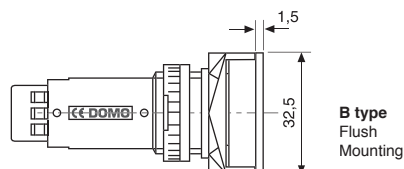

board thickness 1 mm  
clamping: threaded nut

Screw terminal 14 AWG - 2,5mmq

Bicolor

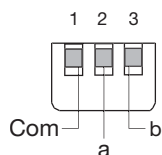

Screw terminal 16 AWG - 0,75 + 1,0mmq

Bicolor + Lamp Test (LT)

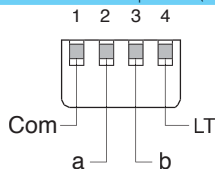

Tricolor

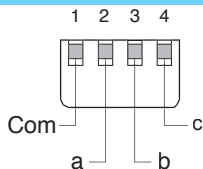

Tricolor + Lamp Test (LT)

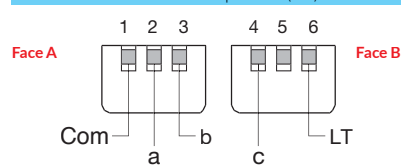

Double Input (2C) + Double Lamp Test (2LT)

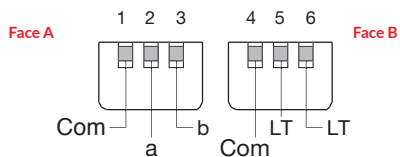

Flying Leads

Bicolor

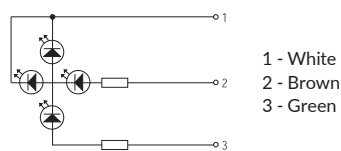

Bicolor + Lamp Test (LT)

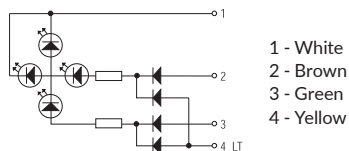

Tricolor

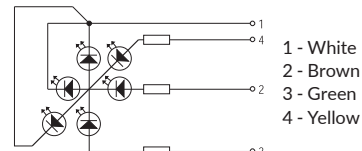

Tricolor + Lamp Test (LT)

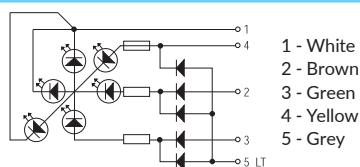

Double Input (2C) + Double Lamp Test (2LT)

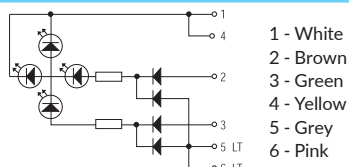

# Series PI - $\varnothing 22\text{mm}$

# Dimensions and wiring

## TV22/30 PI

Dimensions mm 1:2

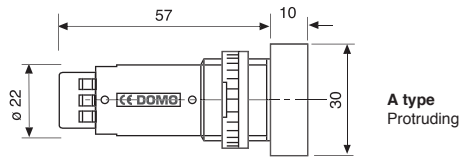

board thickness 10 mm  
clamping: threaded nut

Dimensions mm 1:2

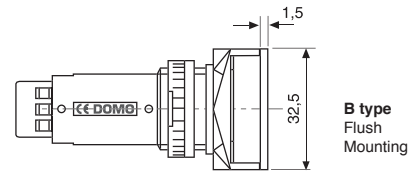

board thickness 1 mm  
clamping: threaded nut

## Screw terminal 14 AWG - 2,5mmq

Monocolor

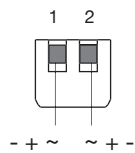

Monocolor + Lamp Test (LT)

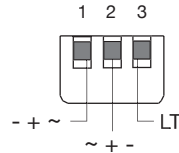

Bicolor

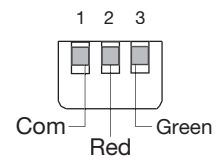

## Flying Leads

Monocolor



Monocolor + Lamp Test (LT)

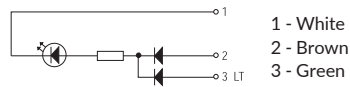

Bicolor

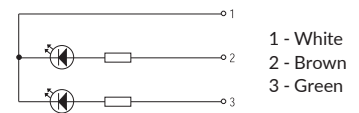



# Series CR - Ø22mm

## Product range

Protruding  
Head Ø48mm  
Cut-out Ø22mm  
Weight 33g



Protruding  
Head 48x48mm  
Cut-out Ø22mm  
Weight 35g

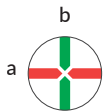

a Red b Green	TV22/48 CRT RG Vxx PD FL PC NC TR LT	TV22/48 CRQ RG Vxx PD FL PC NC TR LT
------------------	-----------------------------------------	-----------------------------------------

# Series PI - Ø22mm

# Product range

Protruding  
Head Ø48mm  
Cut-out Ø22mm  
Weight 31g



Protruding  
Head 48x48mm  
Cut-out Ø22mm  
Weight 33g



● Red	TV22/48 PIR ER Vxx	TV22/48 PIQ ER Vxx
● Green	TV22/48 PIR EG Vxx	TV22/48 PIQ EG Vxx
● Yellow	TV22/48 PIR EY Vxx	TV22/48 PIQ EY Vxx
● Amber	TV22/48 PIR EA Vxx	TV22/48 PIQ EA Vxx
● Blue	TV22/48 PIR EB Vxx	TV22/48 PIQ EB Vxx
○ White	TV22/48 PIR EW Vxx	TV22/48 PIQ EW Vxx

PD FL TR LT

PD FL TR LT

● Red/Green	TV22/48 PIR ERG Vxx	TV22/48 PIQ ERG Vxx
-------------	---------------------	---------------------

PD FL TR

PD FL TR



● Red	TV22/48 PIR DR Vxx	TV22/48 PIQ DR Vxx
● Green	TV22/48 PIR DG Vxx	TV22/48 PIQ DG Vxx
● Yellow	TV22/48 PIR DY Vxx	TV22/48 PIQ DY Vxx
● Amber	TV22/48 PIR DA Vxx	TV22/48 PIQ DA Vxx
● Blue	TV22/48 PIR DB Vxx	TV22/48 PIQ DB Vxx
○ White	TV22/48 PIR DW Vxx	TV22/48 PIQ DW Vxx

PD FL TR LT

PD FL TR LT

● Red/Green	TV22/48 PIR DRG Vxx	TV22/48 PIQ DRG Vxx
-------------	---------------------	---------------------

PD FL TR

PD FL TR



TV22/48 CR

Dimensions mm 1:2

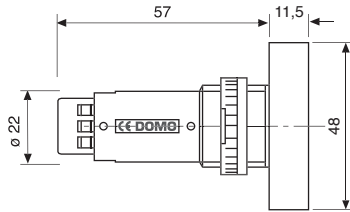

board thickness 10 mm  
clamping: threaded nut

Screw terminal 14 AWG - 2,5mmq

Bicolor

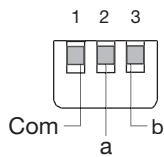

Screw terminal 16 AWG - 0,75 ÷ 1,0mmq

Bicolor + Lamp Test (LT)

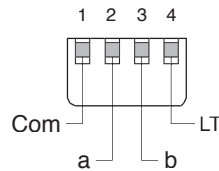

Flying Leads

Bicolor

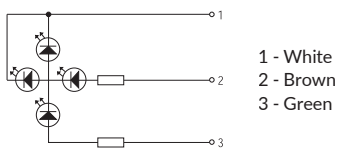

Bicolor + Lamp Test (LT)

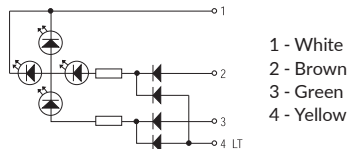

# Series PI - $\varnothing 22\text{mm}$

# Dimensions and wiring

## TV22/48 PI

Dimensions mm 1:2

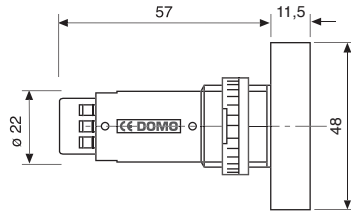

board thickness 10 mm  
clamping: threaded nut

### Screw terminal 14 AWG - 2,5mmq

#### Monocolor

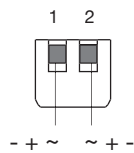

#### Monocolor + Lamp Test (LT)

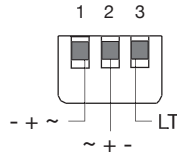

#### Bicolor

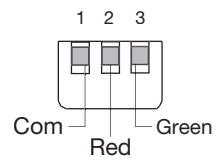

### Flying Leads

#### Monocolor



#### Monocolor + Lamp Test (LT)

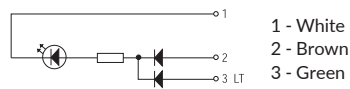

#### Bicolor

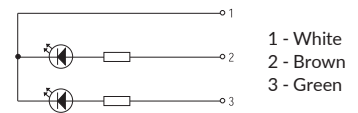

## Accessories and spare parts Ø16mm

**Round label holder**  
Weight 1g



SIM16/24 PTR

**Square label holder**  
Weight 1g



SIM16/24 PTS

**Fastener for type B elements**  
Weight 2g

ASB18  
ASB24

**Reducer ring from Ø22mm  
to Ø16mm**  
Weight 2g



ARF 22/16

**Labels**  
Weight 4g



SIM16/24 TOW

**Protective slides**  
Weight 4g



SIM16/24 VPK

**Tightening wrench**  
Weight 9g



ACK 22/16

**Contact ring filler for Pushbutton  
Switches' central contact**  
Weight 1g



CD16 A3 EC

## Accessories and spare parts Ø22mm

**Round label holder**  
Weight 2g



SIM22/30 PTR

**Square label holder**  
Weight 2g



SIM22/30 PTS

**Fastener for type B elements**  
Weight 3g



ASB 30

**Reducer ring from ø30mm  
to ø22mm**  
Weight 2g



ARF 30/22

**Labels**  
Weight 4g



SIM22/30 TOW

**Protective slides**  
Weight 4g



SIM22/30 VPK

**Tightening wrench**  
Weight 9g



ACK 22/16

**Lamp extractor**  
Weight 2g

Compatible with:  
BA9s, BA7s, T5.5, T5.5k, MG



AEL BA9s/T5.5

**Attention!** DOMO Srl reserves the right to change, amend, modify, suspend, continue or terminate all or any part of the Product range either in an individual case or in general, at any time without notice.

DOMO

## Comparative table



Series	SFT	SLT	CR	PI	ML	VEB	PHR	
	Sferical	Sferical	Semaphore	Position	Multitiled	Extrabright	Beacon	
Page	12	12	26	26	50	64	74	
<b>Function</b>								
Indicator	•	•	•	•	•	•	•	
Buzzer								
Pushbutton								
double pushbutton								
illuminated pushbutton								
Emergency mushroom								
Keylock switch								
selector switch								
Emergency for safety								
<b>Design</b>								
Protruding	•	•	•	•	•	•	•	
Flushmounting			•	•				
Round	•	•	•	•	•	•	•	
Square			•	•	•			
Rectangular								
<b>Front protection (internal test)</b>								
IP40					•			
IP54	•	•	•	•	•		•	
IP65					•	•		
IP67								
<b>Contact rating</b>								
10A								
5A								
<b>Mounting Cut-out</b>								
Ø8								
Ø12								
Ø16	•		•	•		•	•	
Ø22	•	•	•	•	•	•	•	
<b>Terminal</b>								
Faston 2,8x0,8	•	•	•	•	•	•	•	
Faston 2,8x0,5								
Screw	•	•	•	•	•	•	•	
Push-in (future)	F	F	F	F	F	F	F	
BA9s, Ba7s, E10, MG, BA15d, BA15s, E14								
<b>Marking</b>								
Paint, Engraving, Film insert				•	•			
<b>Option</b>								
Lamp Test (LT)	•	•	•	•	•			
Inbuilt Diode to avoid reverse feeding (PD)	•	•	•	•	•			
Tropicalization (TR)	•	•	•	•	•	•	•	
Double input + double lamp test (2C+2LT)			•					
Low voltage glow protection (LVGP)	F	F	F	F	F	F	F	
RGB color		•						
Compatible for DOMO Mosaic Mimic								
Protruding	•	•	•	•	•	•	•	
Flushmounting			•	•	•			

F = Future





# SCATTERGOOD & JOHNSON LTD

ELECTRICAL ENGINEERING & FLUID CONTROL DISTRIBUTORS

Est.1899

At Scattergood & Johnson Ltd, we pride ourselves on being a technical distributor to specialist industries.

Working with a range of quality product manufacturers across a number of specialist markets, we are not your average 'box shifter' - we are your technical and supply chain partner.

We fully support every product we sell - for free! Our internal team and external sales engineers can answer any product or application question, no matter the complexity.

Backing up this technical ability is a range of 50,000+ products available from stock for nationwide next day delivery (same day if required!), or you can collect what you need from any of our trade counters around the UK.

Select your specialist interest below to learn more about how we can help.



Online, In Branch and On the Road - Scattergood & Johnson Ltd, there when you need us.

# [www.scatts.co.uk](http://www.scatts.co.uk)