

## DC/DC converters - QUINT4-PS/24DC/24DC/10/PT/CO - 2910133

Please be informed that the data shown in this PDF Document is generated from our Online Catalog. Please find the complete data in the user's documentation. Our General Terms of Use for Downloads are valid (<http://phoenixcontact.com/download>)



Primary-switched DC/DC converter, QUINT POWER, DIN rail mounting, SFB Technology (Selective Fuse Breaking), Push-in connection, input: 24 V DC , output: 24 V DC / 10 A

### Product Description

QUINT DC/DC converter with maximum functionality

DC/DC converters alter the voltage level, regenerate the voltage at the end of long cables or enable the creation of independent supply systems by means of electrical isolation.

QUINT DC/DC converters magnetically and therefore quickly trip circuit breakers with six times the nominal current, for selective and therefore cost-effective system protection. The high level of system availability is additionally ensured, thanks to preventive function monitoring, as it reports critical operating states before errors occur.

### Your advantages

- ✓ Most powerful output side: easy system expansion, reliable heavy load startup and miniature circuit breaker tripping
- ✓ Most comprehensive signaling: preventive function monitoring reports critical operating states before errors occur
- ✓ Protective coating and ATEX/IECEx approval



COMPLETE line

SFB Technology<sup>®</sup>

Push-in Technology<sup>®</sup>



### Key Commercial Data

Packing unit	1 pc
GTIN	 4 0 5 5 6 2 6 5 3 7 4 2 9
GTIN	4055626537429
Weight per Piece (excluding packing)	1,043.000 g
Custom tariff number	85044030
Country of origin	Thailand
Sales Key	CMDI43

### Technical data

#### Input data

Input voltage range	18 V DC ... 32 V AC
Electric strength, max.	35 V DC (60 s)
Typical current consumption	13.8 A (24 V DC)
Mains buffering	typ. 11 ms (24 V DC)

## DC/DC converters - QUINT4-PS/24DC/24DC/10/PT/CO - 2910133

### Technical data

#### Input data

Switch-on time	< 1 s
Typical response time	300 ms (from SLEEP MODE)
Inrush current limitation typical	1.5 A (after 1 ms)
Inrush current integral ( $I^2t$ )	< 0.02 A <sup>2</sup> s
Input fuse	30 A (slow-blow, internal)

#### Insulation electric strength

Insulation voltage input/output	4 kV DC (type test)
	2 kV DC (routine test)
Type test (IEC/EN 60950-1) A	2 kV DC
Type test (IEC/EN 60950-1) B	4 kV DC
Type test (IEC/EN 60950-1) C	0.5 kV DC
Type test (IEC/EN 60950-1) D	0.5 kV DC
Production test A	2 kV DC
Production test B	2 kV DC
Production test C	0.5 kV DC
Production test D	0.5 kV DC

#### Input connection data

Connection method	Push-in connection
Stripping length	10 mm
Conductor cross section solid	0.2 mm <sup>2</sup> ... 6 mm <sup>2</sup>
Conductor cross section flexible	0.2 mm <sup>2</sup> ... 6 mm <sup>2</sup>
Flexible conductor cross section (ferrule with plastic sleeve)	0.2 mm <sup>2</sup> ... 4 mm <sup>2</sup>
Flexible conductor cross section flexible (ferrule, w/o plastic sleeve)	0.2 mm <sup>2</sup> ... 4 mm <sup>2</sup>
Conductor cross section AWG	24 ... 10

#### Output data

Nominal output voltage ( $U_N$ )	24 V DC
Setting range of the output voltage ( $U_{Set}$ )	24 V DC ... 28 V DC (> 24 V DC, constant capacity)
Nominal output current ( $I_N$ )	10 A
Static Boost ( $I_{Stat.Boost}$ )	12.5 A
Dynamic Boost ( $I_{Dyn.Boost}$ )	20 A (5 s)
Selective Fuse Breaking ( $I_{SFB}$ )	60 A (15 ms)
Magnetic circuit breaker tripping	A1...A6 / B2...B6 / C1...C3 / Z1...Z6
System deviation, static	< 1 % (change in load, static 10 % ... 90 %)
System deviation, dynamic	< 3 % (Dynamic load change 10 % ... 90 %, 10 Hz)
System deviation, input voltage change	< 0.1 % (change in input voltage $\pm$ 10 %)
Short-circuit-proof	yes
No-load proof	yes
Residual ripple	< 50 mV <sub>PP</sub>
Connection in parallel	yes, for redundancy and increased capacity

## DC/DC converters - QUINT4-PS/24DC/24DC/10/PT/CO - 2910133

### Technical data

#### Output data

Connection in series	yes
Feedback voltage resistance	$\leq 35$ V DC
Protection against overvoltage at the output (OVP)	$\leq 30$ V DC
Rise time	$< 1$ s ( $U_{OUT}$ (10 % ... 90 %))

#### Output connection data

Connection method	Push-in connection
Stripping length	10 mm
Conductor cross section solid	0.2 mm <sup>2</sup> ... 6 mm <sup>2</sup>
Conductor cross section flexible	0.2 mm <sup>2</sup> ... 6 mm <sup>2</sup>
Flexible conductor cross section (ferrule with plastic sleeve)	0.2 mm <sup>2</sup> ... 4 mm <sup>2</sup>
Flexible conductor cross section flexible (ferrule, w/o plastic sleeve)	0.2 mm <sup>2</sup> ... 4 mm <sup>2</sup>
Conductor cross section AWG	24 ... 10

#### LED signaling

Types of signaling	LED
	Floating signal contact
	Active signal output Out1 (digital, configurable)
	Active signal output Out2 (analog, configurable)
	Remote contact
	Signal ground SGnd
$P_{Out}$	$> 100$ % (LED lights up yellow, output power $> 240$ W)
	$> 75$ % (LED lights up green, output power $> 180$ W)
	$> 50$ % (LED lights up green, output power $> 120$ W)
$U_{Out}$	$> 0.9 \times U_{Set}$ (LED lights up green)
	$< 0.9 \times U_{Set}$ (LED flashes green)
$U_{In}$	$> 0.8 \times U_{InNom}$ (LED off)
	$< 0.8 \times U_{InNom}$ (LED lights up yellow)

#### Signal contacts – signal output Out 1 (configurable)

Connection labeling	3.5 +
Digital	0 V DC
	24 V DC
	20 mA
Default	$U_{IN}$ input voltage OK
Signal option	Output voltage
	Output current
	Output power
	Operating hours
	Early warning of high temperatures
	OVP voltage limitation active

#### Signal contacts – signal output Out 2 (configurable)

## DC/DC converters - QUINT4-PS/24DC/24DC/10/PT/CO - 2910133

### Technical data

#### Signal contacts – signal output Out 2 (configurable)

Connection labeling	3.6 +
Digital	0 V DC
	24 V DC
	20 mA
Default	Output power
Signal option	Output voltage
	Output current
	Operating hours
	Early warning of high temperatures
	OVP voltage limitation active
Analog	4 mA ... 20 mA $\pm 5\%$ (Load $\leq 400\ \Omega$ )
Signal option	Output voltage
	Output current
	Output power

#### Signal contacts – signal output relay 13/14 (configurable)

Connection labeling	3.1, 3.2
Switch contact	floating
Maximum contact load	24 V DC
	1 A
	30 V AC
	0.5 A
Default	Output voltage
Signal option	Output current
	Output power
	Operating hours
	Early warning of high temperatures
	OVP voltage limitation active
	$U_{IN}$ input voltage OK

#### Signal contacts – remote signal input (configurable)

Connection labeling	3.3 +
Function	Output power ON/OFF (remote)
Default	Output power ON ( $>40\ \text{k}\Omega/24\ \text{V DC}$ /open bridge between REM and SGnd)

#### Signal contacts – signal ground SGnd

Connection labeling	3.4 +
Function	Signal ground
Reference potential	to OUT1, OUT2, REM

#### Signal connection data

Connection method	Push-in connection
-------------------	--------------------

## DC/DC converters - QUINT4-PS/24DC/24DC/10/PT/CO - 2910133

### Technical data

#### Signal connection data

Conductor cross section solid	0.2 mm <sup>2</sup> ... 1 mm <sup>2</sup>
Conductor cross section flexible	0.2 mm <sup>2</sup> ... 1.5 mm <sup>2</sup>
Flexible conductor cross section (ferrule with plastic sleeve)	0.2 mm <sup>2</sup> ... 1.5 mm <sup>2</sup>
Flexible conductor cross section flexible (ferrule, w/o plastic sleeve)	0.2 mm <sup>2</sup> ... 1.5 mm <sup>2</sup>
Conductor cross section AWG	24 ... 16
Stripping length	8 mm

#### Reliability

MTBF (IEC 61709, SN 29500)	> 1380000 h (25 °C)
	> 800000 h (40 °C)
	> 340000 h (60 °C)

#### Life expectancy (electrolytic capacitors)

Output current	5 A
Temperature	40 °C
Time	367721 h
Voltage	24 V DC
Output current	10 A
Temperature	40 °C
Time	183860 h
Voltage	24 V DC
Output current	10 A
Temperature	30 °C
Time	422400 h
Voltage	24 V DC

#### Switching frequency

Auxiliary converter stage	190 kHz ... 220 kHz (Auxiliary converter stage)
Main converter stage	67 kHz ... 135 kHz (Main converter stage)

#### General data

Degree of protection	IP20
Protection class	Special with SELV input and output
Inflammability class in acc. with UL 94 (housing / terminal blocks)	V0
Side element version	Aluminum
Hood version	Stainless steel X6Cr17
Width	50 mm
Height	130 mm
Depth	125 mm
Width with alternative assembly	122 mm
Height with alternative assembly	130 mm
Depth with alternative assembly	53 mm
Weight	0.8 kg

## DC/DC converters - QUINT4-PS/24DC/24DC/10/PT/CO - 2910133

### Technical data

#### General data

Efficiency	typ. 93.3 % (24 V DC)
------------	-----------------------

#### Power dissipation

Maximum power dissipation in no-load condition	< 5 W
Power dissipation SLEEP MODE	< 2 W
Power loss nominal load max.	< 16 W

#### Ambient conditions

Ambient temperature (operation)	-40 °C ... 70 °C (> 60 °C Derating: 2,5 %/K)
Ambient temperature (storage/transport)	-40 °C ... 85 °C
Max. permissible relative humidity (operation)	≤ 100 % (at 25 °C, non-condensing)
Maximum altitude	≤ 5000 m (> 2000 m, observe derating)
Vibration (operation)	5 Hz ... 100 Hz resonance search 2.3g, 90 min., resonance frequency 2.3g, 90 min. (according to DNV GL Class C)
Shock	18 ms, 30g, in each space direction (according to IEC 60068-2-27)
Degree of pollution	2
Climatic class	3K3 (EN 60721)

#### Standards

EMC requirements for noise immunity	EN 61000-6-1
	EN 61000-6-2
EMC requirements for noise emission	EN 61000-6-3
	EN 61000-6-4
EMC requirements, power plant	IEC 61850-3
	EN 61000-6-5
Standard designation	Electrical safety (of control and regulation devices)
Standards/regulations	IEC 61010-1
Standard designation	Protective extra-low voltage
Standards/regulations	EN 61010-1 (SELV)
	IEC 61010-2-201 (PELV)
Standard designation	Explosive atmospheres
Standards/regulations	IEC 60079-0
	IEC 60079-7
	IEC 60079-11
	IEC 60079-15
Standard designation	Mains variation/undervoltage
Standards/regulations	EN 61000-4-29
Overvoltage category EN 61010-1	II
Overvoltage category EN 62477-1	III

#### Conformance/approvals

Designation	UL
Identification	UL Listed UL 61010-1

## DC/DC converters - QUINT4-PS/24DC/24DC/10/PT/CO - 2910133

### Technical data

#### Conformance/approvals

	# II 3 G Ex ec ic nC IIC T4 Gc
Designation	UL
Identification	UL Listed UL 61010-2-201
	Ex ec ic nC IIC T4 Gc
Designation	UL
Identification	UL ANSI/ISA-12.12.01 Class I, Division 2, Groups A, B, C, D T4 (Hazardous Location)
Designation	CSA
Identification	CAN/CSA-C22.2 No. 61010-1-12
Designation	CSA
Identification	CAN/CSA-IEC 61010-2-201:14
Designation	SIQ
Identification	Type tested (type approved)
Designation	SIQ
Identification	CB scheme (IEC 61010-1, IEC 61010-2-201)
Designation	Shipbuilding
Identification	DNV GL
Designation	Shipbuilding
Identification	ABS
Designation	ATEX
Identification	SIQ 21 ATEX 025 X
	# II 3 G Ex ec ic nC IIC T4 Gc
Designation	IECEX
Identification	IECEX SIQ 19.0001X
	Ex ec ic nC IIC T4 Gc

#### EMC data

Electromagnetic compatibility	Conformance with EMC Directive 2014/30/EU
Low Voltage Directive	Conformance with Low Voltage Directive 2014/35/EC
Conducted noise emission	EN 55016
	EN 61000-6-3 (Class B)
Noise emission	EN 55016
	EN 61000-6-3 (Class B)
DNV GL conducted interference	Class B
Additional text	Bridge and deck area
DNV GL noise radiation	Class B
Additional text	Bridge and deck area
Electrostatic discharge	EN 61000-4-2
Contact discharge	8 kV (Test Level 4)
Discharge in air	15 kV (Test Level 4)
Electromagnetic HF field	EN 61000-4-3

## DC/DC converters - QUINT4-PS/24DC/24DC/10/PT/CO - 2910133

### Technical data

#### EMC data

Frequency range	80 MHz ... 1 GHz
Test field strength	20 V/m (Test Level 3)
Frequency range	1 GHz ... 6 GHz
Test field strength	10 V/m (Test Level 3)
Frequency range	1 GHz ... 6 GHz
Test field strength	10 V/m (Test Level 3)
Comments	Criterion A
Fast transients (burst)	EN 61000-4-4
Input	4 kV (Test Level 3 - asymmetrical)
Output	4 kV (Test Level 3 - asymmetrical)
Signal	4 kV (Test Level 4 - asymmetrical)
Comments	Criterion A
Surge voltage load (surge)	EN 61000-4-5
Input	1 kV (Test Level 3 - symmetrical)
	2 kV (Test Level 3 - asymmetrical)
Output	1 kV (Test Level 3 - symmetrical)
	2 kV (Test Level 3 - asymmetrical)
Signal	2 kV (Test Level 3 - asymmetrical)
Comments	Criterion A
Conducted interference	EN 61000-4-6
I/O/S	asymmetrical
Frequency range	0.15 MHz ... 80 MHz
Voltage	10 V (Test Level 3)
Comments	Criterion A
Power frequency magnetic field	EN 61000-4-8
Frequency	16.7 Hz
	50 Hz
	60 Hz
Test field strength	100 A/m
Additional text	60 s
Comments	Criterion A
Frequency	50 Hz
	60 Hz
Frequency range	50 Hz ... 60 Hz
Test field strength	1 kA/m
Additional text	3 s
Comments	Criterion A
Frequency	0 Hz
Test field strength	300 A/m
Additional text	DC, 60 s

## DC/DC converters - QUINT4-PS/24DC/24DC/10/PT/CO - 2910133

### Technical data

#### EMC data

Comments	Criterion A
Voltage dips	EN 61000-4-29
Voltage	24 V DC
Voltage dip	70 %
Additional text	Test Level 2
Comments	Criterion A
Voltage dip	40 %
Additional text	Test Level 2
Comments	Criterion B
Voltage dip	0 %
Additional text	Test Level 2
Comments	Criterion B
Pulse-shape magnetic field	EN 61000-4-9
Test field strength	1000 A/m
Comments	Criterion A
Damped oscillating magnetic field	EN 61000-4-10
Test field strength	100 A/m
Test level 1	100 kHz
Test field strength	100 A/m
Test level 2	1 MHz
Comments	Criterion A
Asymmetrical conducted disturbance variables	EN 61000-4-16
Test level 1	15 Hz 150 Hz (Test Level 4)
Voltage	30 V 3 V
Test level 2	150 Hz 1.5 kHz (Test Level 4)
Voltage	3 V
Test level 3	1.5 kHz 15 kHz (Test Level 4)
Voltage	0 V 3 V
Test level 4	15 kHz 150 kHz (Test Level 4)
Voltage	30 V
Test level 5	16.7 Hz 50 Hz 60 Hz 150 Hz 180 Hz (Test Level 4)
Voltage	30 V (Permanent)
Test level 6	0 Hz 16.7 Hz 50 Hz 60 Hz (Test Level 4)
Voltage	300 V (1 s)
Comments	Criterion A
Alternating component of DC voltage	EN 61000-4-17
Attenuated oscillating wave	EN 61000-4-18
Input, output (test level 1)	100 kHz 1 MHz (Test Level 3 - symmetrical)
Voltage	1 kV
Input, output (test level 2)	100 kHz 1 MHz (Test Level 3 - asymmetrical)

# DC/DC converters - QUINT4-PS/24DC/24DC/10/PT/CO - 2910133

## Technical data

### EMC data

Voltage	2.5 kV
Input, output (test level 3)	10 MHz (Test Level 3 - asymmetrical)
Voltage	2 kV
Signals (test level 1)	100 kHz 1 MHz (Test Level 2 - symmetrical)
Voltage	1 kV
Signals (test level 2)	100 kHz 1 MHz (Test Level 3 - asymmetrical)
Voltage	2.5 kV
Comments	Criterion A
Criterion A	Normal operating behavior within the specified limits.
Criterion B	Temporary impairment to operational behavior that is corrected by the device itself.
Criterion C	Temporary adverse effects on the operating behavior, which the device corrects automatically or which can be restored by actuating the operating elements.

### Environmental Product Compliance

REACH SVHC	Lead 7439-92-1
------------	----------------

## Drawings

Pictogram



Schematic diagram

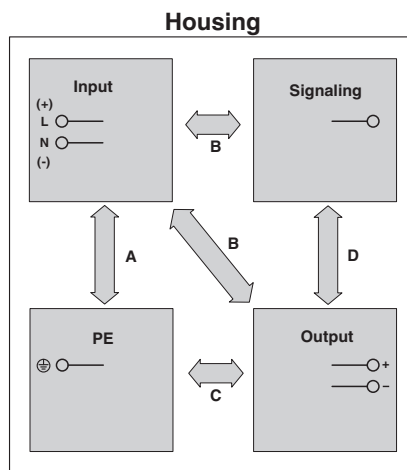

# DC/DC converters - QUINT4-PS/24DC/24DC/10/PT/CO - 2910133

Diagram

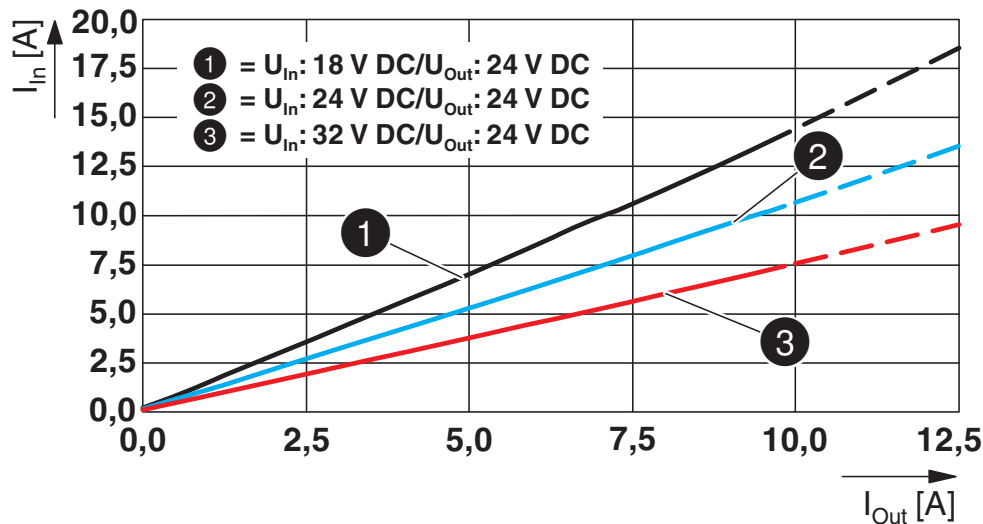

Diagram

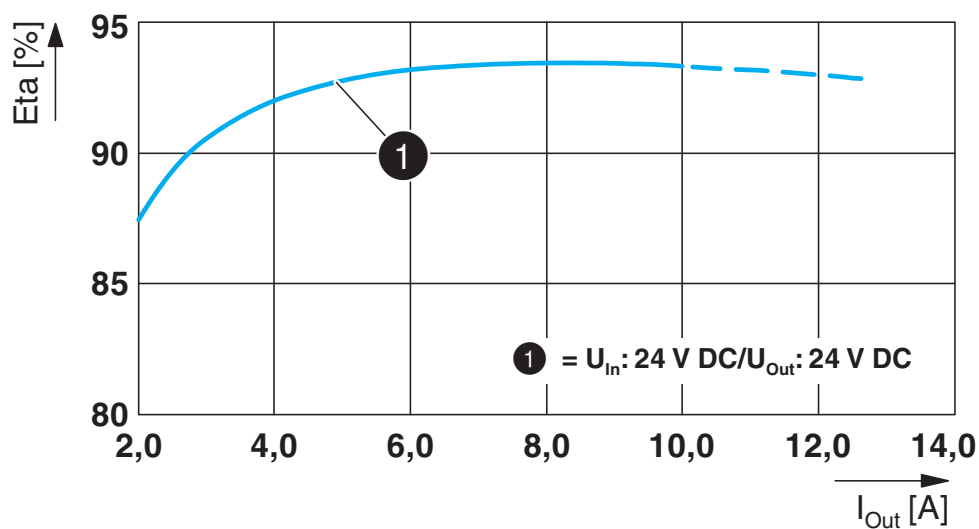

## Classifications

eCl@ss

eCl@ss 11.0	27210901
eCl@ss 9.0	27210901

ETIM

ETIM 7.0	EC002046
----------	----------

## Approvals

Approvals

## DC/DC converters - QUINT4-PS/24DC/24DC/10/PT/CO - 2910133

### Approvals





#### Approvals

cULus Listed / IECCEB Scheme / EAC / DNV GL / NK / LR / LR / IECCEB Scheme / NK / DNV GL / cULus Listed / BV / EAC

#### Ex Approvals





ATEX / cULus Listed / IECEx / IECEx / cULus Listed / ATEX / CCC

#### Approval details

cULus Listed		<a href="http://database.ul.com/cgi-bin/XYV/template/LISEXT/1FRAME/index.htm">http://database.ul.com/cgi-bin/XYV/template/LISEXT/1FRAME/index.htm</a>	FILE E 123528
IECEE CB Scheme		<a href="http://www.iecee.org/">http://www.iecee.org/</a>	SI-8406
EAC			RU S- DE.BL08.W.00764
DNV GL		<a href="https://approvalfinder.dnvgl.com/">https://approvalfinder.dnvgl.com/</a>	TAA000027S
NK		<a href="http://www.classnk.or.jp/hp/en/">http://www.classnk.or.jp/hp/en/</a>	TA21182M
LR		<a href="http://www.lr.org/en">http://www.lr.org/en</a>	17-20107-03
LR		<a href="http://www.lr.org/en">http://www.lr.org/en</a>	17-20107-03
IECEE CB Scheme		<a href="http://www.iecee.org/">http://www.iecee.org/</a>	SI-8406

## DC/DC converters - QUINT4-PS/24DC/24DC/10/PT/CO - 2910133

### Approvals

NK		<a href="http://www.classnk.or.jp/hp/en/">http://www.classnk.or.jp/hp/en/</a>	TA21182M
DNV GL		<a href="https://approvalfinder.dnvgl.com/">https://approvalfinder.dnvgl.com/</a>	TAA000027S
cULus Listed		<a href="http://database.ul.com/cgi-bin/XYV/template/LISEXT/1FRAME/index.htm">http://database.ul.com/cgi-bin/XYV/template/LISEXT/1FRAME/index.htm</a>	FILE E 123528
BV		<a href="http://www.veristar.com/portal/veristarinfo/generalinfo/approved/approvedProducts/equipmentAndMaterials">http://www.veristar.com/portal/veristarinfo/generalinfo/approved/approvedProducts/equipmentAndMaterials</a>	57060/A1 BV
EAC			RU S- DE.BL08.W.00764



**SCATTERGOOD  
& JOHNSON LTD**  
ELECTRICAL ENGINEERING & FLUID CONTROL DISTRIBUTORS

Est.1899

At Scattergood & Johnson Ltd, we pride ourselves on being a technical distributor to specialist industries.

Working with a range of quality product manufacturers across a number of specialist markets, we are not your average 'box shifter' - we are your technical and supply chain partner.

We fully support every product we sell - for free! Our internal team and external sales engineers can answer any product or application question, no matter the complexity.

Backing up this technical ability is a range of 50,000+ products available from stock for nationwide next day delivery (same day if required!), or you can collect what you need from any of our trade counters around the UK.

Select your specialist interest below to learn more about how we can help.

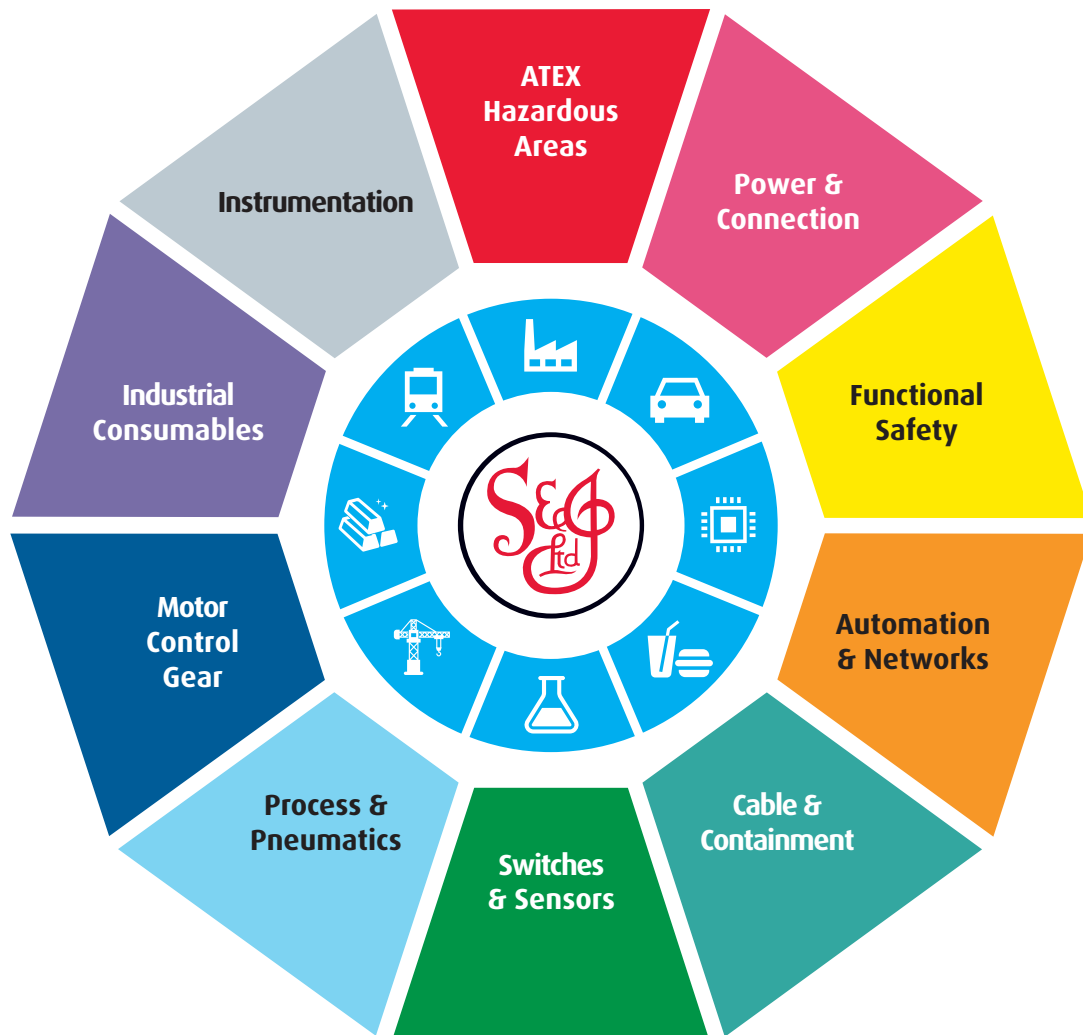

Online, In Branch and On the Road - Scattergood & Johnson Ltd, there when you need us.

**[www.scatts.co.uk](http://www.scatts.co.uk)**