

# Connector - SACC-M12FS-4QO-0,75-M



1641772

<https://www.phoenixcontact.com/gb/products/1641772>

Please be informed that the data shown in this PDF document is generated from our Online Catalog. Please find the complete data in the user documentation. Our General Terms of Use for Downloads are valid.

---



Connector, Universal, 4-position, Socket straight M12, Coding: A, Insulation displacement connection, knurl material: Zinc die-cast, nickel-plated, external cable diameter 4 mm ... 8 mm

## Your advantages

- Safe use in the field, thanks to a high degree of protection
- Insulation displacement connection: innovative and time-saving assembly without stripping the single wire

# Connector - SACC-M12FS-4QO-0,75-M



1641772

<https://www.phoenixcontact.com/gb/products/1641772>

## Commercial Data

Order Key	1641772
Packing unit	1 pc
Minimum order quantity	1 pc
Sales Key	BF2CCA
Product Key	BF2CCA
Catalog Page	Page 20 (C-2-2019)
GTIN	4017918921859
Weight per Piece (including packing)	16.7 g
Weight per Piece (excluding packing)	14.9 g
Customs tariff number	85366990
Country of origin	DE

# Connector - SACC-M12FS-4QO-0,75-M



1641772

<https://www.phoenixcontact.com/gb/products/1641772>

## Technical Data

### Notes

Assembly instruction:

**NOTE:** Observe the permissible bending radii when laying conductors, since the degree of protection may be put in jeopardy if the bending forces are too high. Alleviate mechanical loads upstream of the connector, e.g. by using cable ties.

### Product properties

Number of positions	4
Coding	A - standard

### Insulation characteristics

Overvoltage category	III
Degree of pollution	3

### Ambient conditions

Degree of protection	IP65 IP67
Ambient temperature (operation)	-25 °C ... 80 °C (Plug / socket)
Ambient temperature (assembly)	-5 °C ... 50 °C (During assembly)

### Dimensions

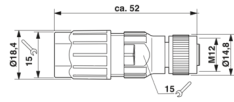
Dimensional drawing	
Length	52 mm

### External dimensions

Outside diameter	4 mm ... 8 mm
------------------	---------------

### Housing

Diameter housing	18.4 mm
------------------	---------

### Connector

Insertion/withdrawal cycles	≥ 100
-----------------------------	-------

### Header 1

Head design	Socket
Head cable outlet	straight
Head thread type	M12
Coding	A-coded

### Electrical properties

# Connector - SACC-M12FS-4QO-0,75-M



1641772

<https://www.phoenixcontact.com/gb/products/1641772>

Rated surge voltage	4 kV
Contact resistance	≤ 5 mΩ
Insulation resistance	≥ 100 MΩ
Nominal voltage U <sub>N</sub>	250 V AC
	250 V DC
Nominal current I <sub>N</sub>	4 A

## Material specifications

Color Handle area	black
Flammability rating according to UL 94	V0
Sealing material	NBR
Material of grip body	PA 6
Contact material	CuSn
Contact surface material	Ni/Au
Contact carrier material	TPU
Cable gland material	Zinc die-cast, nickel-plated
Wire insulation material	PVC / PE / PP / rubber

## Connection data

### Connection technology

Connection method	Insulation displacement connection
Outside diameter	4 mm ... 8 mm

### Conductor connection

Connection method	Insulation displacement connection
Conductor cross section flexible	0.34 mm <sup>2</sup> ... 0.75 mm <sup>2</sup>
Cross section AWG	22 ... 18

### Pin assignment

Contact   Color (signal designation)   Contact (optional)	1 = BN
	2 = WH
	3 = BU
	4 = BK

## Mounting

Assembly instructions	AWG 18 wire cross section upon request
-----------------------	--

## Standards and regulations

### M12

Standards/specifications	according to IEC 61076-2-101
--------------------------	------------------------------

## Cable / line

### Cable structure

Signal type/category	Universal
----------------------	-----------

# Connector - SACC-M12FS-4QO-0,75-M



1641772

<https://www.phoenixcontact.com/gb/products/1641772>

External cable diameter	4 mm ... 8 mm
-------------------------	---------------

# Connector - SACC-M12FS-4QO-0,75-M



1641772

<https://www.phoenixcontact.com/gb/products/1641772>

## Drawings

Dimensional drawing

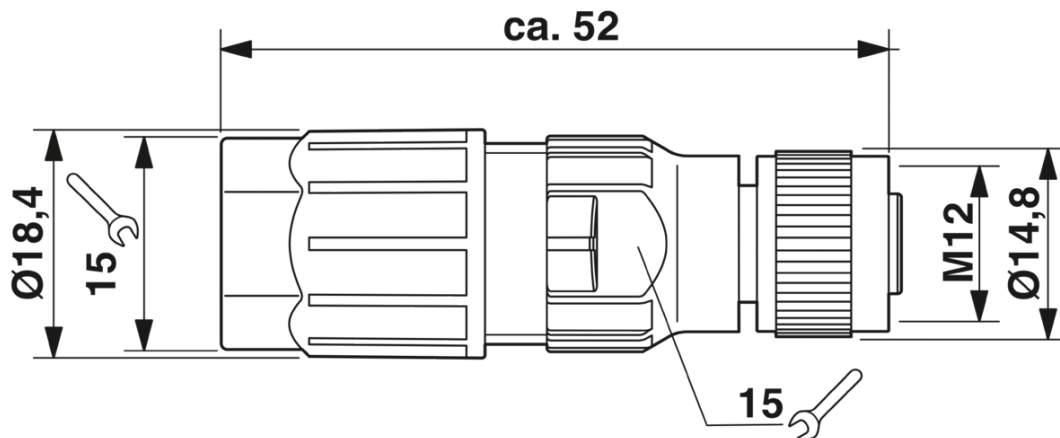

M12 x 1 socket, straight

Functional drawing

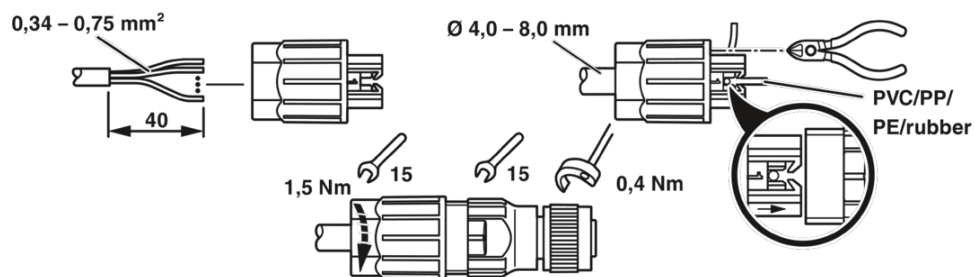

# Connector - SACC-M12FS-4QO-0,75-M



1641772

<https://www.phoenixcontact.com/gb/products/1641772>

Schematic diagram

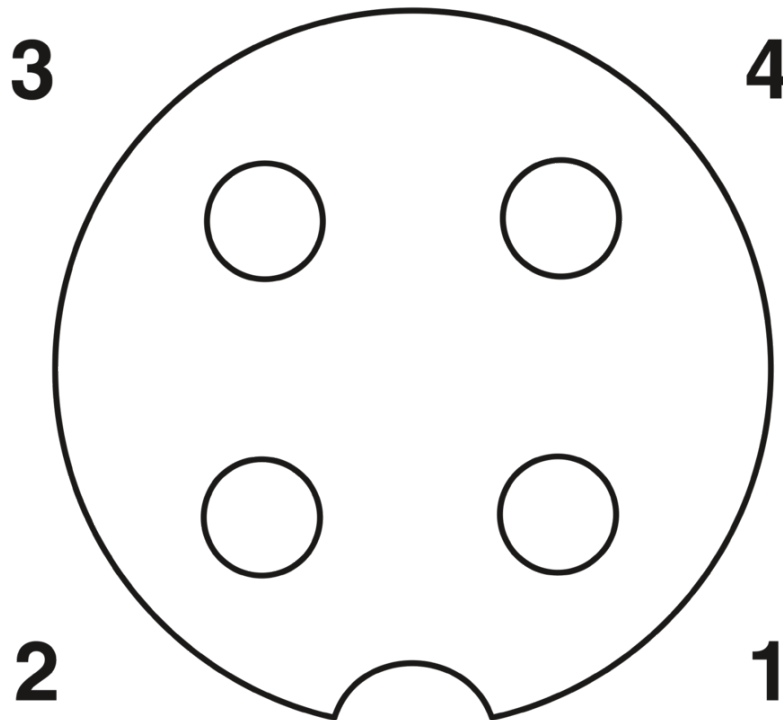

Pin assignment M12 socket, 4-pos., A-coded, view female side

## Connector - SACC-M12FS-4QO-0,75-M





1641772

<https://www.phoenixcontact.com/gb/products/1641772>

## Approvals

cUL Recognized 	Nominal Voltage $U_N$	Nominal Current $I_N$	Cross Section AWG	Cross Section $\text{mm}^2$
	300 V	4 A	-	-

UL Recognized 	Nominal Voltage $U_N$	Nominal Current $I_N$	Cross Section AWG	Cross Section $\text{mm}^2$
	300 V	4 A	-	-

EAC 

EAC 

cULus Recognized

# Connector - SACC-M12FS-4QO-0,75-M



1641772

<https://www.phoenixcontact.com/gb/products/1641772>

## Classifications

### ECLASS

ECLASS-10.0.1	27440102
ECLASS-9.0	27440102
ECLASS-11.0	27440102

### ETIM

ETIM 6.0	EC002062
----------	----------

### UNSPSC

UNSPSC 19.0	39121413
UNSPSC 20.0	39121413
UNSPSC 21.0	39121413

# Connector - SACC-M12FS-4QO-0,75-M



1641772

<https://www.phoenixcontact.com/gb/products/1641772>

## Environmental Product Compliance

China RoHS

Environmentally friendly use period: unlimited = EFUP-e

No hazardous substances above threshold values

Phoenix Contact 2022 © - all rights reserved  
<https://www.phoenixcontact.com>

PHOENIX CONTACT Ltd  
Halesfield 13, Telford  
Shropshire, TF7 4PG  
01952 681700  
[info@phoenixcontact.co.uk](mailto:info@phoenixcontact.co.uk)



**SCATTERGOOD  
& JOHNSON LTD**  
ELECTRICAL ENGINEERING & FLUID CONTROL DISTRIBUTORS

Est.1899

At Scattergood & Johnson Ltd, we pride ourselves on being a technical distributor to specialist industries.

Working with a range of quality product manufacturers across a number of specialist markets, we are not your average 'box shifter' - we are your technical and supply chain partner.

We fully support every product we sell - for free! Our internal team and external sales engineers can answer any product or application question, no matter the complexity.

Backing up this technical ability is a range of 50,000+ products available from stock for nationwide next day delivery (same day if required!), or you can collect what you need from any of our trade counters around the UK.

Select your specialist interest below to learn more about how we can help.



Online, In Branch and On the Road - Scattergood & Johnson Ltd, there when you need us.

**[www.scatts.co.uk](http://www.scatts.co.uk)**