

# Machine Automation Controller

# NX7

**Flagship controller performs large-scale, high-speed, high-accuracy control by synchronizing up to 256 axes with the fastest cycle time of 125  $\mu$ s**



## Features

- Implemented OPC UA as standard feature.  **OPC UA** (NX701-1□□□)
- Integration of Logic and Motion in one CPU.
- Conforms to IEC 61131-3 (JIS B 3503) standard programming and PLCopen function blocks for Motion Control. Programming with variables allows users to create complex programs efficiently.
- Fast and accurate control by synchronizing all EtherCAT devices, such as vision sensors, servo drives, and field devices, with the PLC and Motion Engines.
- Offers speed without compromising on reliability and robustness expected from PLCs.
- Complete RAS functions: Transmission frame error check, timeout, bus diagnosis, Watchdog (WDT), memory check, and topology check, etc.
- Ideal for large-scale, fast, and highly-accurate control with up to 256 axes.
- Linear and circular interpolation.
- Electronic gear and cam synchronization.
- The Controller can be directly connected to a database. No special Unit, software, nor middleware is required. (NX701-1□20)

# NX7

## System Configuration

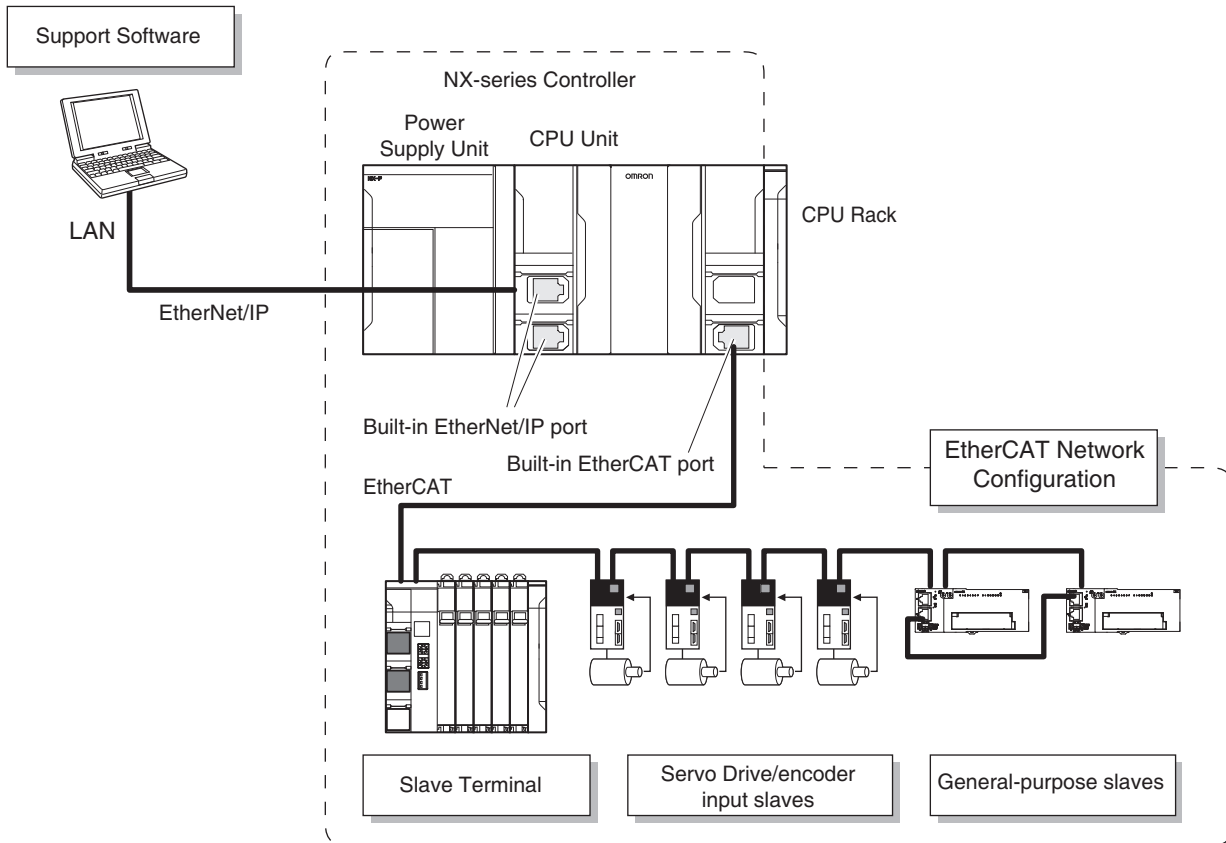



## Ordering Information

### Applicable standards

Refer to the OMRON website ([www.ia.omron.com](http://www.ia.omron.com)) or ask your OMRON representative for the most recent applicable standards for each model.

### NX701 CPU Units

| Product Name  | Specifications   |  |                       | Current (Power) consumption                   | Model         |
|---|------------------|--|-----------------------|---|---------------|
|   | Program capacity | Memory capacity for variables  | Number of motion axes |   |               |
| <b>NX701 CPU Units</b><br>                     | 80 MB            | 4 MB:<br>Retained during power interruption<br>256 MB:<br>Not retained during power interruption | 256                   | 40 W (including SD Memory Card and End Cover) | NX701-1700    |
|   |                  |  | 128                   |   | NX701-1600    |
| <b>NX701 Database Connection CPU Units</b><br> |                  |  | 256                   |   | NX701-1720 *1 |
|   |                  |  | 128                   |   | NX701-1620 *1 |

\*1. NX701-1720-DH, NX701-1620-DH are products equipped with time series data collection system. Consult your Omron sales representative for details.

### Accessories

The following accessories come with the CPU Unit.

| Product Name                  | Model  |                        |
|-------------------------------|--|------------------------|
|                               | NX701-1□00   | NX701-1□20             |
| Battery                       | CJ1W-BAT01   |                        |
| End Cover                     | NX-END01 (must be attached to the right end of the CPU Rack) |                        |
| End Plate                     | ---  |                        |
| Fan Unit                      | NX-FAN01   |                        |
| SD Memory Card (Flash Memory) | ---  | HMC-SD491/HMC-SD492 *1 |

\*1. HMC-SD491 or HMC-SD492 Memory Card is provided with NJ701-1□20.

### Power Supply Units

One Power Supply Unit is required for each Rack.

| Product Name         | Power supply voltage | Output capacity         | Options                     |            |                              | Model     |
|----------------------|----------------------|-------------------------|-----------------------------|------------|------------------------------|-----------|
|                      |                      | Total power consumption | 24-VDC service power supply | RUN output | Maintenance forecast monitor |           |
| AC Power Supply Unit | 100 to 240 VAC       | 90 W                    | No                          | Yes        | No                           | NX-PA9001 |
| DC Power Supply Unit | 24 VDC               | 70 W                    |                             |            |                              | NX-PD7001 |

# NX7

## Automation Software Sysmac Studio

Please purchase a DVD and required number of licenses the first time you purchase the Sysmac Studio. DVDs and licenses are available individually. Each model of licenses does not include any DVD.

| Product name                             | Specifications  | Number of licenses | Media                      | Model            |
|--|---|--------------------|----------------------------|------------------|
|  |   |                    |                            |                  |
| Sysmac Studio Standard Edition Ver.1.□□  | <p>The Sysmac Studio is the software that provides an integrated environment for setting, programming, debugging and maintenance of machine automation controllers including NJ/NX-series CPU Units, NY-series Industrial PC, EtherCAT Slaves, and HMI.</p> <p>Sysmac Studio runs on the following OS.<br/>Windows 7 (32-bit/64-bit version)/Windows 8 (32-bit/64-bit version)/Windows 8.1 (32-bit/64-bit version)/Windows 10 (32-bit/64-bit version) *1</p> <p>The Sysmac Studio Standard Edition DVD includes Support Software to set up EtherNet/IP Units, DeviceNet slaves, Serial Communications Units, and Support Software for creating screens on HMIs (CX-Designer).<br/>For details, refer to your OMRON website.</p> | –<br>(Media only)  | Sysmac Studio (32-bit) DVD | SYSMAC-SE200D    |
|  |   | –<br>(Media only)  | Sysmac Studio (64-bit) DVD | SYSMAC-SE200D-64 |
|  |   | 1 license *2       | –                          | SYSMAC-SE201L    |
| Sysmac Studio Team Development Option *3 | Sysmac Studio Team Development Option is a licence to enable the project version control function.  | 1 license *2       | –                          | SYSMAC-TA401L    |

\*1. Model "SYSMAC-SE200D-64" runs on Windows 10 (64 bit).

\*2. Multi licenses are available for the Sysmac Studio (3, 10, 30, or 50 licenses).

\*3. This product is a license only. You need the Sysmac Studio Standard Edition DVD media to install it.

This option can be used by applying the Team Development Option to Sysmac Studio version 1.20 or higher.  
Project version control function is supported by CPU Unit version 1.16 or later.

## Collection of software functional components Sysmac Library

Please download it from following URL and install to Sysmac Studio.

[http://www.ia.omron.com/sysmac\\_library/](http://www.ia.omron.com/sysmac_library/)

### Typical Models

| Product                          | Features   | Model        |
|----------------------------------|--|--------------|
| Vibration Suppression Library    | The Vibration Suppression Library is used to suppress residual vibration caused by the operation of machines.  | SYSMAC-XR006 |
| Device Operation Monitor Library | The Device Operation Monitor Library is used to monitor the operation of devices such as air cylinders, sensors, motors, and other devices.                          | SYSMAC-XR008 |
| Dimension Measurement Library    | The Dimension Measurement Library is used to dimension measurement with ZW-8000/7000/5000 Confocal Fiber Displacement Sensor, or E9NC-TA0 Contact-Type Smart Sensor. | SYSMAC-XR014 |

## Recommended EtherCAT and EtherNet/IP Communications Cables





Use a straight STP (shielded twisted-pair) cable of category 5 or higher with double shielding (aluminum tape and braiding) for EtherCAT.

For EtherNet/IP, required specification for the communications cables varies depending on the baud rate.

For 100BASE-TX/10BASE-T, use a straight or cross STP (shielded twisted-pair) cable of category 5 or higher.

For 1000BASE-T, use a straight or cross STP cable of category 5e or higher with double shielding (aluminum tape and braiding).

### Cable with Connectors

| Item  | Recommended manufacturer  | Cable length (m) | Model            |                      |
|---|---|------------------|------------------|----------------------|
| Wire Gauge and Number of Pairs:<br>AWG26, 4-pair Cable<br>Cable Sheath material: LSZH *2  | Cable with Connectors on Both Ends<br>(RJ45/RJ45)<br>Standard RJ45 plug type *1<br>Cable color: Yellow *3<br>  | OMRON            | 0.3              | XS6W-6LSZH8SS30CM-Y  |
|   |   |                  | 0.5              | XS6W-6LSZH8SS50CM-Y  |
|   |   |                  | 1                | XS6W-6LSZH8SS100CM-Y |
|   |   |                  | 2                | XS6W-6LSZH8SS200CM-Y |
|   |   |                  | 3                | XS6W-6LSZH8SS300CM-Y |
|   |   |                  | 5                | XS6W-6LSZH8SS500CM-Y |
| Wire Gauge and Number of Pairs:<br>AWG22, 2-pair cable  | Cable with Connectors on Both Ends<br>(RJ45/RJ45)<br>Rugged RJ45 plug type *1<br>Cable color: Light blue<br>   | OMRON            | 0.3              | XS5W-T421-AMD-K      |
|   |   |                  | 0.5              | XS5W-T421-BMD-K      |
|   |   |                  | 1                | XS5W-T421-CMD-K      |
|   |   |                  | 2                | XS5W-T421-DMD-K      |
|   |   |                  | 5                | XS5W-T421-GMD-K      |
|   |   |                  | 10               | XS5W-T421-JMD-K      |
|   | Cable with Connectors on Both Ends<br>(M12 Straight/M12 Straight)<br>Shield Strengthening Connector cable *4<br>M12/Smartclick Connectors<br>Cable color: Black<br> | OMRON            | 0.5              | XS5W-T421-BM2-SS     |
|   |   |                  | 1                | XS5W-T421-CM2-SS     |
|   |   |                  | 2                | XS5W-T421-DM2-SS     |
|   |   |                  | 3                | XS5W-T421-EM2-SS     |
|   |   |                  | 5                | XS5W-T421-GM2-SS     |
|   |   |                  | 10               | XS5W-T421-JM2-SS     |
| Cable with Connectors on Both Ends<br>(M12 Straight/RJ45)<br>Shield Strengthening Connector cable *4<br>M12/Smartclick Connectors<br>Rugged RJ45 plug type<br>Cable color: Black<br> | OMRON   | 0.5              | XS5W-T421-BMC-SS |                      |
|   |   | 1                | XS5W-T421-CMC-SS |                      |
|   |   | 2                | XS5W-T421-DMC-SS |                      |
|   |   | 3                | XS5W-T421-EMC-SS |                      |
|   |   | 5                | XS5W-T421-GMC-SS |                      |
|   |   | 10               | XS5W-T421-JMC-SS |                      |

\*1. Cables with standard RJ45 plugs are available in the following lengths: 0.2 m, 0.3 m, 0.5 m, 1 m, 1.5 m, 2 m, 3 m, 5 m, 7.5 m, 10 m, 15 m, 20 m. Cables with rugged RJ45 plugs are available in the following lengths: 0.3 m, 0.5 m, 1 m, 2 m, 3 m, 5 m, 10 m, 15 m.

For details, refer to the *Industrial Ethernet Connectors Catalog* (Cat. No. G019).

\*2. The lineup features Low Smoke Zero Halogen cables for in-cabinet use and PUR cables for out-of-cabinet use. Although the LSZH cable is single shielded, its communications and noise characteristics meet the standards.

\*3. Cable colors are available in yellow, green, and blue.

\*4. For details, contact your OMRON representative.



## NX Units

### Digital Input Units

| Product Name  | Specification    |                     |   |   |                         | Model       |
|---|------------------|---------------------|---|---|-------------------------|-------------|
|   | Number of points | Internal I/O common | Rated input voltage                                 | I/O refreshing method   | ON/OFF response time    |             |
| <br>(Screwless Clamping Terminal Block, 12 mm Width)   | 4 points         | NPN                 | 12 to 24 VDC  | Switching Synchronous I/O refreshing and Free-Run refreshing<br>Input refreshing with input changed time only * | 20 μs max./400 μs max.  | NX-ID3317   |
|   |                  |                     | 24 VDC  |   | 100 ns max./100 ns max. | NX-ID3343   |
|   |                  |                     |   |   |                         | NX-ID3344   |
|   |                  | PNP                 | 12 to 24 VDC  | Switching Synchronous I/O refreshing and Free-Run refreshing<br>Input refreshing with input changed time only * | 20 μs max./400 μs max.  | NX-ID3417   |
|   |                  |                     |   |   | 100 ns max./100 ns max. | NX-ID3443   |
|   |                  |                     |   |   |                         | NX-ID3444   |
|   | 8 points         | NPN                 | 24 VDC  | Switching Synchronous I/O refreshing and Free-Run refreshing  | 20 μs max./400 μs max.  | NX-ID4342   |
|   |                  | PNP                 |   |   |                         | NX-ID4442   |
|   | 16 points        | NPN                 | 24 VDC  | Switching Synchronous I/O refreshing and Free-Run refreshing  | 20 μs max./400 μs max.  | NX-ID5342   |
|   |                  | PNP                 |   |   |                         | NX-ID5442   |
| <br>(M3 Screw Terminal Block, 30 mm Width)             | 16 points        | For both NPN/PNP    | 24 VDC  | Switching Synchronous I/O refreshing and Free-Run refreshing  | 20 μs max./400 μs max.  | NX-ID5142-1 |
| <br>(MIL Connector, 30 mm Width)                      | 16 points        | For both NPN/PNP    | 24 VDC  | Switching Synchronous I/O refreshing and Free-Run refreshing  | 20 μs max./400 μs max.  | NX-ID5142-5 |
|   | 32 points        |                     |   |   |                         | NX-ID6142-5 |
| <br>(Fujitsu Connector, 30 mm Width)                 | 32 points        | For both NPN/PNP    | 24 VDC  | Switching Synchronous I/O refreshing and Free-Run refreshing  | 20 μs max./400 μs max.  | NX-ID6142-6 |
| <br>(Screwless Clamping Terminal Block, 12 mm Width) | 4 points         |                     | 200 to 240 VAC, 50/60 Hz<br>(170 to 264 VAC, ±3 Hz) | Free-Run refreshing   | 10 ms max./40 ms max.   | NX-IA3117   |

\* To use input refreshing with input changed time, the EtherCAT Coupler Unit with unit version 1.1 or later and the Sysmac Studio version 1.07 or higher are required.



## NX7

## Digital output Units

| Product Name  | Specification  |                     |  |                        |   |                             | Model                       |             |
|---|--|---------------------|--|------------------------|---|-----------------------------|-----------------------------|-------------|
|   | Number of points   | Internal I/O common | Maximum value of load current  | Rated voltage          | I/O refreshing method   | ON/OFF response time        |                             |             |
|  <p>(Screwless Clamping Terminal Block, 12 mm Width)</p>               | 2 points   | NPN                 | 0.5 A/point,<br>1 A/Unit   | 24 VDC                 | Output refreshing with specified time stamp only *              | 300 ns max./<br>300 ns max. | NX-OD2154                   |             |
|   |  | PNP                 |  |                        |   |                             | NX-OD2258                   |             |
|   | 4 points   | NPN                 | 0.5 A/point,<br>2 A/Unit   | 12 to 24 VDC           | Switching Synchronous<br>I/O refreshing and Free-Run refreshing | 0.1 ms max./<br>0.8 ms max. | NX-OD3121                   |             |
|   |  |                     |  |                        |   |                             | PNP                         | NX-OD3153   |
|   |  | PNP                 |  | 24 VDC                 |   |                             | 0.5 ms max./<br>1.0 ms max. | NX-OD3256   |
|   |  |                     |  | 2 A/point,<br>8 A/Unit |   |                             | 300 ns max./<br>300 ns max. | NX-OD3257   |
|   | 8 points   | NPN                 | 0.5 A/point,<br>4 A/Unit   | 12 to 24 VDC           | 0.1 ms max./<br>0.8 ms max.                                     | NX-OD4121                   |                             |             |
|   |  | PNP                 |  | 24 VDC                 | 0.5 ms max./<br>1.0 ms max.                                     | NX-OD4256                   |                             |             |
|   | 16 points  | NPN                 | 0.5 A/point,<br>4 A/Unit   | 12 to 24 VDC           | 0.1 ms max./<br>0.8 ms max.                                     | NX-OD5121                   |                             |             |
|   |  | PNP                 |  | 24 VDC                 | 0.5 ms max./<br>1.0 ms max.                                     | NX-OD5256                   |                             |             |
|   |  <p>(M3 Screw Terminal Block, 30 mm Width)</p> | 16 points           | NPN  | 12 to 24 VDC           | Switching Synchronous<br>I/O refreshing and Free-Run refreshing | 0.1 ms max./<br>0.8 ms max. | NX-OD5121-1                 |             |
|   |  |                     | PNP  | 24 VDC                 |   |                             | 0.5 ms max./<br>1.0 ms max. | NX-OD5256-1 |
|  <p>(MIL Connector, 30 mm Width)</p>                                 | 16 points  | NPN                 | 0.5 A/point,<br>2 A/Unit   | 12 to 24 VDC           | 0.1 ms max./<br>0.8 ms max.                                     | NX-OD5121-5                 |                             |             |
|   |  | PNP                 |  |                        |   | 24 VDC                      | 0.5 ms max./<br>1.0 ms max. | NX-OD5256-5 |
|   | 32 points  | NPN                 | 0.5 A/point,<br>2 A/common,<br>4 A/Unit                                  | 12 to 24 VDC           | Switching Synchronous<br>I/O refreshing and Free-Run refreshing | 0.1 ms max./<br>0.8 ms max. | NX-OD6121-5                 |             |
|   |  | PNP                 |  | 24 VDC                 |   |                             | 0.5 ms max./<br>1.0 ms max. | NX-OD6256-5 |
|  <p>(Fujitsu Connector, 30 mm Width)</p>                             | 32 points  | NPN                 | 0.5 A/point,<br>2 A/common,<br>4 A/Unit                                  | 12 to 24 VDC           | Switching Synchronous<br>I/O refreshing and Free-Run refreshing | 0.1 ms max./<br>0.8 ms max. | NX-OD6121-6                 |             |
|  <p>(Screwless Clamping Terminal Block, 12 mm Width/24 mm Width)</p> | 2 points   | N.O.                | 250 VAC/2 A (cosφ=1)<br>250 VAC/2 A (cosφ=0.4)<br>24 VDC/2 A<br>4 A/Unit | Free-Run refreshing    | 15 ms max./15<br>ms max.  | NX-OC2633                   |                             |             |
|   |  | N.O.+N.C.           |  |                        |   | NX-OC2733                   |                             |             |
|   | 8 points   | N.O.                | 250 VAC/2 A (cosφ=1)<br>250 VAC/2 A (cosφ=0.4)<br>24 VDC/2 A<br>8 A/Unit | Free-Run refreshing    | 15 ms max./15<br>ms max.  | NX-OC4633                   |                             |             |

\* To use input refreshing with input changed time, the EtherCAT Coupler Unit with unit version 1.1 or later and the Sysmac Studio version 1.07 or higher are required.

## Digital Mixed I/O Units



| Product Name  | Specification                           |  |   |  |  | Model              |
|---|---|--|---|--|--|--------------------|
|   | Number of points                        | Internal I/O common                      | Maximum value of load current           | I/O refreshing method  | ON/OFF response time   |                    |
| <b>DC Input/Transistor Output Unit</b><br><br>(MIL Connector, 30 mm Width)     | Outputs: 16 points<br>Inputs: 16 points | Outputs: NPN<br>Inputs: For both NPN/PNP | Outputs: 12 to 24 VDC<br>Inputs: 24 VDC | Switching Synchronous I/O refreshing and Free-Run refreshing | Outputs: 0.1 ms max./0.8 ms max.<br>Inputs: 20 μs max./400 μs max. | <b>NX-MD6121-5</b> |
|   |   | Outputs: PNP<br>Inputs: For both NPN/PNP | Outputs: 24 VDC<br>Inputs: 24 VDC       |  | Outputs: 0.5 ms max./1.0 ms max.<br>Inputs: 20 μs max./400 μs max. | <b>NX-MD6256-5</b> |
| <b>DC Input/Transistor Output Unit</b><br><br>(Fujitsu Connector, 30 mm Width) | Outputs: 16 points<br>Inputs: 16 points | Outputs: NPN<br>Inputs: For both NPN/PNP | Outputs: 12 to 24 VDC<br>Inputs: 24 VDC | Switching Synchronous I/O refreshing and Free-Run refreshing | Outputs: 0.1 ms max./0.8 ms max.<br>Inputs: 20 μs max./400 μs max. | <b>NX-MD6121-6</b> |

## High-speed Analog Input Units



| Product name   | Specifications   |   |  |                    |                  |                       |                     | Model                      |  |
|--|------------------|---|--|--------------------|------------------|-----------------------|---------------------|----------------------------|--|
|  | Number of points | Input range   | Resolution   | Input method       | Conversion time  | Trigger input section |                     |                            | I/O refreshing method                    |
|  |                  |   |  |                    |                  | Number of points      | Internal I/O common |                            |  |
| <b>High-speed Analog Input Unit</b><br> | 4                | -10 to 10 V<br>-5 to 5 V<br>0 to 10 V<br>0 to 5 V<br>1 to 5 V<br>0 to 20 mA<br>4 to 20 mA | <ul style="list-style-type: none"> <li>Input range of -10 to 10 V or -5 to 5 V: 1/64,000 (full scale)</li> <li>Other input range: 1/32,000 (full scale)</li> </ul> | Differential input | 5 μs per channel | 4                     | NPN<br><br>PNP      | Synchronous I/O refreshing | <b>NX-HAD401</b><br><br><b>NX-HAD402</b> |

## NX7



## Analog Input Units

| Product Name  | Specification      |              |                    |  |                          |  |                     |                 |  | Model               |
|---|--------------------|--------------|--------------------|--|--------------------------|--|---------------------|-----------------|--|---------------------|
|   | Number of points   | Input range  | Resolution         | Conversion value, decimal number (0 to 100%) | Over all accuracy (25°C) | Input method   | Conversion time     | Input impedance | I/O refreshing method  |                     |
| Voltage Input Unit<br> | 2 points           | -10 to +10 V | 1/8000             | -4000 to 4000                                | ±0.2% (full scale)       | Single-ended input   | 250 µs/point        | 1 MΩ min.       | Free-Run refreshing  | NX-AD2603           |
|   |                    |              | Differential Input | NX-AD2604                                    |                          |  |                     |                 |  |                     |
|   | 4 points           |              | 1/30000            | -15000 to 15000                              | ±0.1% (full scale)       | Differential Input   | 10 µs/point         |                 | Selectable Synchronous I/O refreshing or Free-Run refreshing | NX-AD2608           |
|   |                    |              | 8 points           | 1/8000                                       | -4000 to 4000            | ±0.2% (full scale)   | Single-ended input  |                 | 250 µs/point   | Free-Run refreshing |
|   | Differential Input |              |                    | NX-AD3604                                    |                          |  |                     |                 |  |                     |
|   | 4 points           |              | 1/30000            | -15000 to 15000                              | ±0.1% (full scale)       | Differential Input   | 10 µs/point         |                 | Selectable Synchronous I/O refreshing or Free-Run refreshing | NX-AD3608           |
| 8 points  |                    | 1/8000       | -4000 to 4000      | ±0.2% (full scale)                           | Single-ended input       | 250 µs/point   | Free-Run refreshing | NX-AD4603       |  |                     |
|   | Differential Input | NX-AD4604    |                    |  |                          |  |                     |                 |  |                     |
| Current Input Unit<br> | 2 points           | 4 to 20 mA   | 1/8000             | 0 to 8000                                    | ±0.2% (full scale)       | Single-ended input   | 250 µs/point        | 250 Ω           | Free-Run refreshing  | NX-AD2203           |
|   |                    |              | Differential Input | NX-AD2204                                    |                          |  |                     |                 |  |                     |
|   | 4 points           |              | 1/30000            | 0 to 30000                                   | ±0.1% (full scale)       | Differential Input   | 10 µs/point         |                 | Selectable Synchronous I/O refreshing or Free-Run refreshing | NX-AD2208           |
|   |                    |              | 8 points           | 1/8000                                       | 0 to 8000                | ±0.2% (full scale)   | Single-ended input  |                 | 250 µs/point   | Free-Run refreshing |
|   | Differential Input |              |                    | NX-AD3204                                    |                          |  |                     |                 |  |                     |
|   | 4 points           |              | 1/30000            | 0 to 30000                                   | ±0.1% (full scale)       | Differential Input   | 10 µs/point         |                 | Selectable Synchronous I/O refreshing or Free-Run refreshing | NX-AD3208           |
| 8 points  |                    | 1/8000       | 0 to 8000          | ±0.2% (full scale)                           | Single-ended input       | 250 µs/point   | Free-Run refreshing | NX-AD4203       |  |                     |
|   | Differential Input | NX-AD4204    |                    |  |                          |  |                     |                 |  |                     |
| 4 points  | 1/30000            | 0 to 30000   | ±0.1% (full scale) | Differential Input                           | 10 µs/point              | Selectable Synchronous I/O refreshing or Free-Run refreshing | NX-AD4208           |                 |  |                     |



## Analog Output Units

| Product Name   | Specification    |              |            |  |                          |                 |  | Model     |
|--|------------------|--------------|------------|--|--------------------------|-----------------|--|-----------|
|  | Number of points | Input range  | Resolution | Output setting value, decimal number (0 to 100%) | Over all accuracy (25°C) | Conversion time | I/O refreshing method  |           |
| Voltage Output Unit<br> | 2 points         | -10 to +10 V | 1/8000     | -4000 to 4000                                    | ±0.3% (full scale)       | 250 µs/point    | Free-Run refreshing  | NX-DA2603 |
|  |                  |              | 1/30000    | -15000 to 15000                                  | ±0.1% (full scale)       | 10 µs/point     | Selectable Synchronous I/O refreshing or Free-Run refreshing | NX-DA2605 |
|  | 4 points         |              | 1/8000     | -4000 to 4000                                    | ±0.3% (full scale)       | 250 µs/point    | Free-Run refreshing  | NX-DA3603 |
|  |                  |              | 1/30000    | -15000 to 15000                                  | ±0.1% (full scale)       | 10 µs/point     | Selectable Synchronous I/O refreshing or Free-Run refreshing | NX-DA3605 |
| Current Output Unit<br> | 2 points         | 4 to 20 mA   | 1/8000     | 0 to 8000  | ±0.3% (full scale)       | 250 µs/point    | Free-Run refreshing  | NX-DA2203 |
|  |                  |              | 1/30000    | 0 to 30000                                       | ±0.1% (full scale)       | 10 µs/point     | Selectable Synchronous I/O refreshing or Free-Run refreshing | NX-DA2205 |
|  | 4 points         |              | 1/8000     | 0 to 8000  | ±0.3% (full scale)       | 250 µs/point    | Free-Run refreshing  | NX-DA3203 |
|  |                  |              | 1/30000    | 0 to 30000                                       | ±0.1% (full scale)       | 10 µs/point     | Selectable Synchronous I/O refreshing or Free-Run refreshing | NX-DA3205 |

**Temperature Control Units**

| Product name  | Specifications     |  |                                  |                         |                           |                         |                 |                       | Model     |
|---|--------------------|--|----------------------------------|-------------------------|---------------------------|-------------------------|-----------------|-----------------------|-----------|
|   | Number of channels | Input type   | Output                           | Number of output points | Number of CT input points | Control type            | Conversion time | I/O refreshing method |           |
| <b>Temperature Control Unit 2-channel Type</b><br> | 2                  | Universal input (thermocouple, resistance thermometer) | Voltage output (for driving SSR) | 2                       | 2                         | Standard control        | 50 ms           | Free-Run refreshing   | NX-TC2405 |
|   |                    |  |                                  |                         | None                      | Standard control        |                 |                       | NX-TC2406 |
|   |                    |  | Voltage output (for driving SSR) | 4                       | None                      | Heating/cooling control |                 |                       | NX-TC2407 |
|   |                    |  | Linear current output            | 2                       | None                      | Standard control        |                 |                       | NX-TC2408 |
| <b>Temperature Control Unit 4-channel Type</b><br> | 4                  |  | Voltage output (for driving SSR) | 4                       | 4                         | Standard control        |                 |                       | NX-TC3405 |
|   |                    |  |                                  |                         | None                      | Standard control        |                 |                       | NX-TC3406 |
|   |                    |  | Voltage output (for driving SSR) | 8                       | None                      | Heating/cooling control |                 |                       | NX-TC3407 |
|   |                    |  | Linear current output            | 4                       | None                      | Standard control        |                 |                       | NX-TC3408 |

**Temperature Input Units**

| Product Name  | Specification    |  |                   |  |                  |                       |                  | Model            |           |
|---|------------------|--|-------------------|--|------------------|-----------------------|------------------|------------------|-----------|
|   | Number of points | Input type   | Resolution (25°C) | Over all accuracy (25°C)                 | Conversion time  | I/O refreshing method | Terminals        |                  |           |
| <b>Thermocouple Input type</b><br>           | 2 points         | Thermocouple   | 0.1°C max. *1     | Refer to your OMRON website for details. | 250 ms/Unit      | Free-Run refreshing   | 16 Terminals     | NX-TS2101        |           |
|   | 4 points         |  |                   |  |                  |                       | 16 Terminals x 2 | NX-TS3101        |           |
|   | 2 points         |  | 0.01°C max.       |  | 10 ms/Unit       |                       | 16 Terminals     | NX-TS2102        |           |
|   | 4 points         |  |                   |  | 16 Terminals x 2 |                       | NX-TS3102        |                  |           |
|   | 2 points         |  | 0.001°C max.      |  | 60 ms/Unit       |                       | 16 Terminals     | NX-TS2104        |           |
|   | 4 points         |  |                   |  |                  |                       | 16 Terminals x 2 | NX-TS3104        |           |
| <b>Resistance Thermometer Input type</b><br> | 2 points         | Resistance Thermometer (Pt100/Pt1000, three-wire) *2 | 0.1°C max.        |  | 250 ms/Unit      |                       |                  | 16 Terminals     | NX-TS2201 |
|   | 4 points         |  |                   |  |                  |                       |                  | 16 Terminals x 2 | NX-TS3201 |
|   | 2 points         |  | 0.01°C max.       |  | 10 ms/Unit       |                       |                  | 16 Terminals     | NX-TS2202 |
|   | 4 points         |  |                   |  |                  |                       |                  | 16 Terminals x 2 | NX-TS3202 |
|   | 2 points         |  | 0.001°C max.      |  | 60 ms/Unit       |                       |                  | 16 Terminals     | NX-TS2204 |
|   | 4 points         |  |                   |  |                  |                       |                  | 16 Terminals x 2 | NX-TS3204 |

\*1. The resolution is 0.2°C max. when the input type is R, S, or W.  
 \*2. The NX-TS2202 and NX-TS3202 only supports Pt100 three-wire sensor.

**Heater Burnout Detection Units**

| Product Name  | Specification    |                        |                        |                     |                         |               |                       | Model     |
|---|------------------|------------------------|------------------------|---------------------|-------------------------|---------------|-----------------------|-----------|
|   | CT input section |                        | Control output section |                     |                         |               |                       |           |
|   | Number of inputs | Maximum heater current | Number of outputs      | Internal I/O common | Maximum load current    | Rated voltage | I/O refreshing method |           |
| <b>Heater Burnout Detection Unit</b><br> | 4                | 50 AAC                 | 4                      | NPN                 | 0.1 A/point, 0.4 A/Unit | 12 to 24 VDC  | Free-Run refreshing   | NX-HB3101 |
|   |                  |                        |                        | PNP                 |                         | 24 VDC        |                       | NX-HB3201 |

# NX7

## Load Cell Input Unit

| Product Name  | Specification                    |                  |   |                              |                  | Model     |
|---|----------------------------------|------------------|---|------------------------------|------------------|-----------|
|   | Number of Model Standards points | Conversion cycle | I/O refreshing method *   | Load cell excitation voltage | Input range      |           |
| <br>Load Cell Input Unit | 1                                | 125 $\mu$ s      | <ul style="list-style-type: none"> <li>Free-Run refreshing</li> <li>Synchronous I/O refreshing</li> <li>Task period prioritized refreshing</li> </ul> | 5 VDC $\pm$ 10%              | -5.0 to 5.0 mV/V | NX-RS1201 |

\* Refer to the *NX-series Load Cell Input Unit User's Manual (W565)* for detailed information on I/O refresh cycle.

## Position interface: Incremental Encoder Input Units

| Product Name  | Specification      |                 |                            |   |                              | Model     |
|---|--------------------|-----------------|----------------------------|---|------------------------------|-----------|
|   | Number of channels | External inputs | Maximum response frequency | I/O refreshing method   | Number of I/O entry mappings |           |
| <br>Incremental Encoder Input Unit | 1 (NPN)            | 3 (NPN)         | 500 kHz                    | <ul style="list-style-type: none"> <li>Free-Run refreshing</li> <li>Synchronous I/O refreshing</li> </ul> | 1/1                          | NX-EC0112 |
|   | 1 (PNP)            | 3 (PNP)         |                            |   |                              | NX-EC0122 |
|   | 1                  | 3 (NPN)         | 4 MHz                      |   |                              | NX-EC0132 |
|   |                    | 3 (PNP)         |                            |   | NX-EC0142                    |           |
|   | 2 (NPN)            | None            | 500 kHz                    |   | 2/2                          | NX-EC0212 |
|   | 2 (PNP)            |                 |                            |   |                              | NX-EC0222 |

## Position interface: SSI Input Units

| Product Name  | Specification      |                       |                     |                      |   | Model     |
|---|--------------------|-----------------------|---------------------|----------------------|---|-----------|
|   | Number of channels | Input/Output form     | Maximum data length | Encoder power supply | Type of external connections                    |           |
| <br>SSI Input Unit | 1                  | EIA standard RS-422-A | 32 bits             | 24 VDC, 0.3 A/CH     | Screwless push-in terminal block (12 terminals) | NX-ECS112 |
|   | 2                  | EIA standard RS-422-A | 32 bits             | 24 VDC, 0.3 A/CH     | Screwless push-in terminal block (12 terminals) | NX-ECS212 |

## Position interface: Pulse Output Units

| Product Name   | Specification         |                   |                    |                            |   |                              |                          | Model       |
|--|-----------------------|-------------------|--------------------|----------------------------|---|------------------------------|--------------------------|-------------|
|  | Number of channels *1 | External inputs   | External outputs   | Maximum pulse output speed | I/O refreshing method   | Number of I/O entry mappings | Control output interface |             |
| <br>Pulse Output Unit | 1 (NPN)               | 2 (NPN)           | 1 (NPN)            | 500 kpps                   | <ul style="list-style-type: none"> <li>Synchronous I/O refreshing</li> <li>Task period prioritized refreshing *2</li> </ul> | 1/1                          | Open collector output    | NX-PG0112   |
|  | 1 (PNP)               | 2 (PNP)           | 1 (PNP)            |                            |   |                              |                          | NX-PG0122   |
|  | 2                     | 5 inputs/CH (NPN) | 3 outputs/CH (NPN) | 4 Mpps                     |   | 2/2                          | Line driver output       | NX-PG0232-5 |
|  |                       | 5 inputs/CH (PNP) | 3 outputs/CH (PNP) |                            |   |                              |                          | NX-PG0242-5 |
|  | 4                     | 5 inputs/CH (NPN) | 3 outputs/CH (NPN) |                            |   | 4/4                          |                          | NX-PG0332-5 |
|  |                       | 5 inputs/CH (PNP) | 3 outputs/CH (PNP) |                            |   |                              |                          | NX-PG0342-5 |

\*1. This is the number of pulse output channels.

\*2. Unit version 1.2 or later and an NX-ECC203 EtherCAT Coupler Unit are required.

## Communications Interface Units

| Product Name   | Serial interface | External connection terminals     | Number of serial ports | Communications protocol   | Model     |
|--|------------------|-----------------------------------|------------------------|---|-----------|
| <br>Communications Interface Unit | RS-232C          | Screwless Clamping Terminal Block | 1 port                 | <ul style="list-style-type: none"> <li>No-protocol</li> <li>Signal lines</li> </ul> | NX-CIF101 |
|  | RS-422A/485      |                                   |                        |   | NX-CIF105 |
|  | RS-232C          | D-Sub connector                   | 2 ports                |   | NX-CIF210 |

## RFID Units

| Product name | Amplifier/Antenna | No. of unit numbers used | Model     |
|--------------|-------------------|--------------------------|-----------|
|              | V680 series       | 1                        | NX-V680C1 |
|              |                   | 2                        | NX-V680C2 |

## IO-Link Master Unit

| Product Name | Specification           |                       |                                   | Model     |
|--------------|-------------------------|-----------------------|-----------------------------------|-----------|
|              | Number of IO-Link ports | I/O refreshing method | I/O connection terminals          |           |
|              | 4                       | Free-Run refreshing   | Screwless clamping terminal block | NX-ILM400 |

## System Units

| Product Name | Specification   | Model     |
|--------------|---|-----------|
|              | Power supply voltage: 24 VDC (20.4 to 28.8 VDC)<br>NX Bus power supply capacity: 10 W max.                                    | NX-PD1000 |
|              | Power supply voltage: 5 to 24 VDC (4.5 to 28.8 VDC)<br>I/O power feed maximum current: 4 A                                    | NX-PF0630 |
|              | Power supply voltage: 5 to 24 VDC (4.5 to 28.8 VDC)<br>I/O power feed maximum current: 10 A *                                 | NX-PF0730 |
|              | Number of I/O power terminals: IOG: 16 terminals<br>Current capacity of I/O power terminal: 4 A/terminal max.                 | NX-PC0010 |
|              | Number of I/O power terminals: IOV: 16 terminals<br>Current capacity of I/O power terminal: 4 A/terminal max.                 | NX-PC0020 |
|              | Number of I/O power terminals: IOV: 8 terminals, IOG: 8 terminals<br>Current capacity of I/O power terminal: 4 A/terminal max | NX-PC0030 |
|              | Number of shield terminals: 14 terminals<br>(The following two terminals are functional ground terminals.)                    | NX-TBX01  |

# NX7

## EtherCAT Coupler Units



NX-series Units on previous pages and NX-series Safety Units can be used by connecting to the EtherCAT Coupler Unit that is connected to the built-in EtherCAT port on the NX7 CPU Unit.

| Product Name  | Communications cycle in DC Mode | Current consumption | Maximum I/O power supply current | Model     |
|---|---------------------------------|---------------------|----------------------------------|-----------|
|  | 250 to 4000 $\mu$ s *2          | 1.45 W max.         | 4 A                              | NX-ECC201 |
|   | 250 to 4000 $\mu$ s *2          |                     | 10 A                             | NX-ECC202 |
|   | 125 to 10000 $\mu$ s *2         | 1.25 W max.         |                                  | NX-ECC203 |



\*1. One End Cover NX-END01 is provided with the EtherCAT Coupler Unit.

\*2. This depends on the specifications of the EtherCAT master. For example, the values are as follows when the EtherCAT Coupler Unit is connected to the built-in EtherCAT port on an NJ5-series CPU Unit: 500  $\mu$ s, 1,000  $\mu$ s, 2,000  $\mu$ s, and 4,000  $\mu$ s. Refer to the *NJ/NX-series CPU Unit Built-in EtherCAT Port User Manual* (Cat. No. W505) for the specifications of the built-in EtherCAT ports on NJ/NX-series CPU Units. This also depends on the unit configuration.



## Safety CPU Units

| Appearance   | Specification                       |                  |                                     |                       |              | Model     |
|--|-------------------------------------|------------------|-------------------------------------|-----------------------|--------------|-----------|
|  | Maximum number of safety I/O points | Program capacity | Number of safety master connections | I/O refreshing method | Unit version |           |
|   | 256 points                          | 512 KB           | 32                                  | Free-Run refreshing   | Ver.1.1      | NX-SL3300 |
|  | 1024 points                         | 2048 KB          | 128                                 | Free-Run refreshing   | Ver.1.1      | NX-SL3500 |

## Safety Input Units

| Appearance  | Specification                 |                              |                      |                     |                                    |                                    |                       |              | Model     |
|---|-------------------------------|------------------------------|----------------------|---------------------|------------------------------------|------------------------------------|-----------------------|--------------|-----------|
|   | Number of safety input points | Number of test output points | Internal I/O common  | Rated input voltage | OMRON special safety input devices | Number of safety slave connections | I/O refreshing method | Unit version |           |
|  | 4 points                      | 2 points                     | Sinking inputs (PNP) | 24 VDC              | Can be connected.                  | 1                                  | Free-Run refreshing   | Ver.1.1      | NX-SIH400 |
|  | 8 points                      | 2 points                     | Sinking inputs (PNP) | 24 VDC              | Cannot be connected.               | 1                                  | Free-Run refreshing   | Ver.1.0      | NX-SID800 |

## Safety Output Units

| Appearance  | Specification                        |                        |   |               |                                    |                       |              | Model     |
|---|--------------------------------------|------------------------|---|---------------|------------------------------------|-----------------------|--------------|-----------|
|   | Number of Model safety output points | Internal I/O common    | Maximum load current  | Rated voltage | Number of safety slave connections | I/O refreshing method | Unit version |           |
|  | 2 points                             | Sourcing outputs (PNP) | 2.0 A/point, 4.0 A/Unit at 40°C, and 2.5A/Unit at 55°C<br>The maximum load current depends on the installation orientation and ambient temperature. | 24 VDC        | 1                                  | Free-Run refreshing   | Ver.1.0      | NX-SOH200 |
|  | 4 points                             | Sourcing outputs (PNP) | 0.5 A/point and 2.0 A/Unit  | 24 VDC        | 1                                  | Free-Run refreshing   | Ver.1.0      | NX-SOD400 |

## General Specifications

| Item                                   |   | NX701-□□□□  |
|--|---|---|
| <b>Enclosure</b>                       |   | Mounted in a panel  |
| <b>Grounding Method</b>                |   | Ground to less than 100 Ω   |
| <b>Dimensions (height×depth×width)</b> |   | 100 mm × 100 mm × 132 mm  |
| <b>Weight</b>                          |   | 880 g (including the End Cover)   |
| <b>Power consumption</b>               |   | 40 W (including SD Memory Card and End Cover)   |
| <b>Operation Environment</b>           | <b>Ambient Operating Temperature</b>  | 0 to 55°C   |
|  | <b>Ambient Operating Humidity</b>   | 10% to 95%<br>(with no condensation)  |
|  | <b>Atmosphere</b>   | Must be free from corrosive gases.  |
|  | <b>Ambient Storage Temperature</b>  | -25 to 70°C<br>(excluding battery and fan unit)   |
|  | <b>Altitude</b>   | 2,000 m or less   |
|  | <b>Pollution Degree</b>   | 2 or less: Meets IEC 61010-2-201.   |
|  | <b>Noise Immunity</b>   | 2 kV on power supply line (Conforms to IEC 61000-4-4.)  |
|  | <b>Overvoltage Category</b>   | Category II: Meets IEC 61010-2-201.   |
|  | <b>EMC Immunity Level</b>   | Zone B  |
|  | <b>Vibration Resistance</b>   | Conforms to IEC 60068-2-6.<br>5 to 8.4 Hz with 3.5-mm amplitude, 8.4 to 150 Hz<br>Acceleration of 9.8 m/s <sup>2</sup> for 100 min in X, Y, and Z directions (10 sweeps of 10 min each = 100 min total) |
| <b>Shock Resistance</b>                | Conforms to IEC 60068-2-27.<br>147 m/s <sup>2</sup> , 3 times in X, Y, and Z directions (100 m/s <sup>2</sup> for Relay Output Units) |   |
| <b>Battery</b>                         | <b>Life</b>   | 2.5 years (at 25°C, Power ON time rate 0% (power OFF))  |
|  | <b>Model</b>  | CJ1W-BAT01  |
| <b>Applicable Standards</b>            |   | Conforms to cULus, NK *, LR *, EU Directives, RCM and KC Registration.  |

\* Supported only by the CPU Units manufactured in December 2016 or later. Not supported by the NX701-1□20.

## NX7

## Performance Specifications

| Item                     |   | NX701-   |   |  |
|--------------------------|---|--|---|--|
|                          |   | 17□0   | 16□0  |  |
| Processing Time          | Instruction Execution Times   | LD instruction   | 0.37 ns or more   |  |
|                          |   | Math Instructions (for Long Real Data)   | 3.2 ns or more  |  |
| Programming              | Program capacity *1   | Size   | 80 MB (1600 KS)   |  |
|                          |   | Number   | POU definition  | 6,000  |
|                          |   |  | POU instance  | 48,000   |
|                          | Variables capacity  | No Retain Attribute *2   | Size  | 256 MB   |
|                          |   |  | Number  | 360,000  |
|                          |   | Retain Attribute *3  | Size  | 4 MB   |
|                          |   |  | Number  | 40,000   |
|                          | Data type   | Number   | 8,000   |  |
|                          | Memory for CJ-Series Units (Can be Specified with AT Specifications for Variables.)             | CIO Area   | NX701-1□00: ---<br>NX701-1□20: 6144 words (CIO 0 to CIO 6143) *4  |  |
|                          |   | Work Area  | NX701-1□00: ---<br>NX701-1□20: 512 words (W0 to W511) *4  |  |
| Holding Area             |   | NX701-1□00: ---<br>NX701-1□20: 1536 words (H0 to H1535) *5                                 |   |  |
| DM Area                  |   | NX701-1□00: ---<br>NX701-1□20: 32768 words (D0 to D32767) *5                               |   |  |
| EM Area                  |   | NX701-1□00: ---<br>NX701-1□20: 32768 words × 25 banks (E0_00000 to E18_32767) *6           |   |  |
| Unit Configuration       | Maximum Number of Connectable Units   | Maximum number of NX unit on the system<br>4,096<br>(on NX series EtherCAT slave terminal) |   |  |
|                          | Maximum number of Expansion Racks   | 0  |   |  |
|                          | Power Supply Unit for CPU Rack and Expansion Racks  | Model  | NX-PA9001<br>NX-PD7001  |  |
| Power OFF Detection Time |   | AC Power Supply  | 30 to 45 ms   |  |
|                          |   | DC Power Supply  | 5 to 20ms   |  |
| Motion Control           | Number of Controlled Axes   | Maximum Number of Controlled Axes  | Maximum number of axes which can be defined.<br>256 axes   128 axes   |  |
|                          |   | Motion control axes  | Maximum number of motion control axes which can be defined.<br>All motion control function is available.          |  |
|                          |   |  | 256 axes   128 axes   |  |
|                          |   | Maximum number of used real axes   | Maximum number of used real axes.<br>The Number of used real axes includes following servo axes and encoder axes. |  |
|                          |   |  | 256 axes   128 axes   |  |
|                          |   |  | Used motion control servo axes  | Maximum number of servo axes which all motion control function is available. |
|                          | 256 axes   128 axes   |  |   |  |
|                          | Maximum number of axes for linear interpolation axis control                                    | 4 axes per axes group  |   |  |
|                          | Number of axes for circular interpolation axis control  | 2 axes per axes group  |   |  |
|                          | Maximum Number of Axes Groups   | 64 groups  |   |  |
| Motion Control Period    | The same control period as that is used for the process data communications cycle for EtherCAT. |  |   |  |
| Cams                     | Number of Cam Data Points   | Maximum Points per Cam Table   | 65,535 points   |  |
|                          |   | Maximum Points for All Cam Tables  | 1,048,560 points  |  |
|                          | Maximum Number of Cam Tables  | 640 tables   |   |  |
| Position Units           | Pulses, millimeters, micrometers, nanometers, degrees or inches                                 |  |   |  |
| Override Factors         | 0.00% or 0.01% to 500.00%   |  |   |  |

\*1. This is the capacity for the execution objects and variable tables (including variable names).

\*2. Words for CJ-series Units in the Holding, DM, and EM Areas are not included. For NX701-1□20, Words for CJ-series Units are included.

\*3. Words for CJ-series Units in the CIO and Work Areas are not included. For NX701-1□20, Words for CJ-series Units are included.

\*4. You can set the size in 1ch unit. Use Non-Retain attribute memory.

\*5. You can set the size in 1ch unit. Use Retain attribute memory.

\*6. NX701-1□20 use the dedicated area for the spool function. Even if the spool function is valid, Retain attribute memory is not used.

| Item                                 |  | NX701-  |  |  |
|--------------------------------------|--|---|--|--|
|                                      |  | 17□0  | 16□0   |  |
| Built-in EtherNet/IP Port            | Number of port   | 2   |  |  |
|                                      | Physical Layer   | 10BASE-T/100BASE-TX /1000BASE-T   |  |  |
|                                      | Frame length   | 1514 max.   |  |  |
|                                      | Media Access Method  | CSMA/CD   |  |  |
|                                      | Modulation   | Baseband  |  |  |
|                                      | Topology   | Star  |  |  |
|                                      | Baud Rate  | 1Gbps (1000BASE-T)  |  |  |
|                                      | Transmission Media   | STP (shielded, twisted-pair) cable of Ethernet category 5, 5e or higher |  |  |
|                                      | Maximum Transmission Distance between Ethernet Switch and Node | 100m  |  |  |
|                                      | Maximum Number of Cascade Connections                          | There are no restrictions if Ethernet switch is used.                   |  |  |
|                                      | CIP service: Tag Data Links (Cyclic Communications)            | Maximum Number of Connections   | 256 / port<br>total 512  |  |
|                                      |  | Packet interval *7  | 0.5 to 10,000 ms in 0.5-ms increments<br>Can be set for each connection.             |  |
|                                      |  | Permissible Communications Band   | 40,000 pps *8<br>including heartbeat   |  |
|                                      |  | Maximum Number of Tag Sets  | 256 / port<br>total 512  |  |
|                                      |  | Tag types   | Network variables  |  |
|                                      |  | Number of tags per connection (i.e., per tag set)                       | 8 (7 tags if Controller status is included in the tag set.)                          |  |
|                                      |  | Maximum Link Data Size per Node (total size for all tags)               | 256 / port<br>total 512  |  |
|                                      |  | Maximum number of tag   | 369,664 byte<br>(Total in 2 ports 739,328 byte)                                      |  |
|                                      |  | Maximum Data Size per Connection  | 1,444 byte   |  |
|                                      |  | Maximum Number of Registrable Tag Sets                                  | 256 / port<br>total 512<br>(1 connection = 1 tag set)                                |  |
|                                      |  | Maximum Tag Set Size  | 1,444 bytes<br>(Two bytes are used if Controller status is included in the tag set.) |  |
|                                      |  | Multi-cast Packet Filter *9   | Supported.   |  |
|                                      | Cip Message Service: Explicit Messages                         | Class 3 (number of connections)   | 128 / port total 256<br>(clients plus server)  |  |
| UCMM (non-connection type)           |  | Maximum Number of Clients that Can Communicate at One Time              | 32 / port<br>total 64  |  |
|                                      |  | Maximum Number of Servers that Can Communicate at One Time              | 32 / port<br>total 64  |  |
| Maximum number of TCP socket service | 30   |   |  |  |

\*7. Data is updated on the line in the specified interval regardless of the number of nodes.

\*8. Means packets per second, i.e., the number of communications packets that can be sent or received in one second.

\*9. An IGMP client is mounted for the EtherNet/IP port. If an ethernet switch that supports IGMP snooping is used, filtering of unnecessary multicast packets is performed.

## NX7

| Item                            |   | NX701-  |  |       |
|---------------------------------|---|---|--|-------|
|                                 |   | 17□0  | 16□0   |       |
| Built-in EtherNet/IP Port       | OPC UA Server   | Support Profile/Model   | Micro Embedded Device<br>Server Profile<br>PLCopen Information Model   |       |
|                                 |   | Default Endpoint/Port   | opc.tcp://192.168.250.1:4840/  |       |
|                                 |   | Maximum number of sessions (Client)   | 5  |       |
|                                 |   | Maximum number of Monitored Items per server  | 2,000  |       |
|                                 |   | Sampling rate of the Monitored Items (ms)   | 0, 50, 100, 250, 500, 1000,2000, 5000, 10000<br>if set to 0 (zero), it is assumed that is set to 50.   |       |
|                                 |   | Maximum number of Subscriptions per server  | 100  |       |
|                                 |   | Maximum number of variables that can be published   | 10,000   |       |
|                                 |   | Maximum number of value attributes that can be published *10  | 10,000   |       |
|                                 |   | Maximum number of structure definitions that can be published   | 100  |       |
|                                 |   | Restrictions on variables unable to be published  | <ul style="list-style-type: none"> <li>• Variable which size are over 1024Bytes</li> <li>• Double and over dimensional array of structures</li> <li>• Structures includes double and over dimensional array</li> <li>• Structures nested 4 and over Unions</li> <li>• Array which's index number don't start from 0</li> <li>• Array which's element is over 1024</li> <li>• Structures which's members are over 100.</li> </ul> |       |
|                                 |   | SecurityPolicy/Mode   | None <ul style="list-style-type: none"> <li>• Sign - Basic128Rsa15</li> <li>• Sign - Basic256</li> <li>• Sign - Basic256Sha256</li> <li>• SignAndEncrypt - Basic128Rsa15</li> <li>• SignAndEncrypt - Basic256</li> <li>• SignAndEncrypt - Basic256Sha256</li> </ul>  |       |
|                                 |   | Application Authentication  | Authentication   | X.509 |
| Maximum number of certification | Trusted certification: 32<br>Issuer certification: 32<br>Rejected certification: 32   |   |  |       |
| User Authentication             | Authentication  | User name / Password<br>Anonymous   |  |       |
| Built-in EtherCAT Port          | Communications Standard   | IEC 61158 Type12  |  |       |
|                                 | EtherCAT Master Specifications  | Class B (Feature Pack Motion Control compliant)   |  |       |
|                                 | Physical Layer  | 100BASE-TX  |  |       |
|                                 | Modulation  | Baseband  |  |       |
|                                 | Baud Rate   | 100 Mbps (100Base-TX)   |  |       |
|                                 | Duplex mode   | Auto  |  |       |
|                                 | Topology  | Line, daisy chain, and branching  |  |       |
|                                 | Transmission Media  | Twisted-pair cable of category 5 or higher (double-shielded straight cable with aluminum tape and braiding) |  |       |
|                                 | Maximum Transmission Distance between Nodes   | 100m  |  |       |
|                                 | Maximum Number of Slaves  | 512   |  |       |
|                                 | Range of node address   | 1-512   |  |       |
|                                 | Maximum Process Data Size   | Inputs: 11,472 bytes<br>Outputs: 11,472 bytes *11   |  |       |
|                                 | Maximum Process Data Size per Slave   | Inputs: 1,434 bytes<br>Outputs: 1,434 bytes   |  |       |
| Communications Cycle            | <ul style="list-style-type: none"> <li>• Primary periodic task: 125 μs, 250 μs to 8 ms (in 250-μs increments)</li> <li>• Priority-5 periodic task: 125 μs, 250 μs to 100 ms (in 250-μs increments)</li> </ul> |   |  |       |
| Sync Jitter                     | 1 μs max.   |   |  |       |
| Internal Clock                  | At ambient temperature of 55°C: -3.5 to +0.5 min error per month<br>At ambient temperature of 25°C: -1.5 to +1.5 min error per month<br>At ambient temperature of 0°C: -3 to +1 min error per month           |   |  |       |

\*10.The number of value attributes is defined by the following formula.

Number of value attributes = (Number of basic data type variables) + (Number of array-specified elements) + (Number of values in the structure)

\*11.The data must be within eight frames.

## Function Specifications

| Item                 |  |   | NX701-□□□□  |   |  |
|----------------------|--|---|---|---|--|
| Tasks                | Function   | I/O refreshing and the user program are executed in units that are called tasks. Tasks are used to specify execution conditions and execution priority. |   |   |  |
|                      |  | Periodically Executed Tasks   | Maximum Number of Primary Periodic Tasks  | 1   |  |
|                      |  |   | Maximum Number of Periodic Tasks  | 4   |  |
|                      |  | Conditionally executed tasks  | Maximum number of event tasks   | 32  |  |
| Execution conditions | When Activate Event Task instruction is executed or when condition expression for variable is met. |   |   |   |  |
| Programming          | POU (program organization units)   | Programs  |   | POUs that are assigned to tasks.  |  |
|                      |  | Function Blocks   |   | POUs that are used to create objects with specific conditions.  |  |
|                      |  | Functions   |   | POUs that are used to create an object that determine unique outputs for the inputs, such as for data processing. |  |
|                      | Programming Languages  | Types   |   | Ladder diagrams *1 and structured text (ST)   |  |
|                      | Namespaces   |   | A concept that is used to group identifiers for POU definitions.  |   |  |
|                      | Variables  | External Access of Variables  | Network Variables   | The function which allows access from the HMI, host computers, or other Controllers                               |  |
|                      | Data Types   | Data Types  | Data Types  | Boolean   | BOOL   |
|                      |  |   |   | Bit Strings   | BYTE, WORD, DWORD, LWORD                         |
|                      |  |   |   | Integers  | INT, SINT, DINT, LINT, UINT, USINT, UDINT, ULINT |
|                      |  |   |   | Real Numbers  | REAL, LREAL                                      |
|                      |  |   |   | Durations   | TIME   |
|                      |  |   |   | Dates   | DATE   |
|                      |  |   |   | Times of Day  | TIME_OF_DAY                                      |
|                      |  |   |   | Date and Time   | DATE_AND_TIME                                    |
|                      |  | Text Strings  | STRING  |   |  |
|                      |  | Derivative Data Types   |   | Structures, unions, enumerations  |  |
|                      |  | Structures  | Function  | A derivative data type that groups together data with different variable types.                                   |  |
|                      |  |   | Maximum Number of Members   | 2048  |  |
|                      |  |   | Nesting Maximum Levels  | 8   |  |
|                      | Member Data Types  |   | Basic data types, structures, unions, enumerations, array variables   |   |  |
| Unions               | Specifying Member Offsets  | You can use member offsets to place structure members at any memory locations.  |   |   |  |
|                      | Function   | A derivative data type that groups together data with different variable types.   |   |   |  |
|                      | Maximum Number of Members  | 4   |   |   |  |
| Enumerations         | Member Data Types  | BOOL, BYTE, WORD, DWORD, LWORD  |   |   |  |
|                      | Function   | A derivative data type that uses text strings called enumerators to express variable values.  |   |   |  |
| Data Type Attributes | Array Specifications   | Function  | An array is a group of elements with the same data type. You specify the number (subscript) of the element from the first element to specify the element. |   |  |
|                      |  | Maximum Number of Dimensions  | 3   |   |  |
|                      |  | Maximum Number of Elements  | 65535   |   |  |
|                      |  | Array Specifications for FB Instances   | Supported.  |   |  |
|                      | Range Specifications   | You can specify a range for a data type in advance. The data type can take only values that are in the specified range.                                 |   |   |  |
| Libraries            | User libraries   |   |   |   |  |

\*1. Inline ST is supported. (Inline ST is ST that is written as an element in a ladder diagram.)

## NX7

| Item                                    |  | NX701-□□□□  |  |  |
|---|--|---|--|--|
| Motion Control                          | <b>Control Modes</b>   |   | position control, velocity control, torque control   |  |
|   | <b>Axis Types</b>  |   | Servo axes, virtual servo axes, encoder axes, and virtual encoder axes   |  |
|   | <b>Positions that can be managed</b>   |   | Command positions and actual positions   |  |
|   | Single-axis  | Single-axis Position Control  | <b>Absolute Positioning</b>  | Positioning is performed for a target position that is specified with an absolute value.   |
|   |  |   | <b>Relative Positioning</b>  | Positioning is performed for a specified travel distance from the command current position.  |
|   |  |   | <b>Interrupt Feeding</b>   | Positioning is performed for a specified travel distance from the position where an interrupt input was received from an external input. |
|   |  |   | <b>Cyclic synchronous absolute positioning</b>   | The function which outputs command positions in every control period in the position control mode.                                       |
|   |  | Single-axis Velocity Control  | <b>Velocity Control</b>  | Velocity control is performed in Position Control Mode.  |
|   |  |   | <b>Cyclic Synchronous Velocity Control</b>   | A velocity command is output each control period in Velocity Control Mode.   |
|   |  | Single-axis Torque Control  | <b>Torque Control</b>  | The torque of the motor is controlled.   |
|   |  | Single-axis Synchronized Control  | <b>Starting Cam Operation</b>  | A cam motion is performed using the specified cam table.   |
|   |  |   | <b>Ending Cam Operation</b>  | The cam motion for the axis that is specified with the input parameter is ended.   |
|   |  |   | <b>Starting Gear Operation</b>   | A gear motion with the specified gear ratio is performed between a master axis and slave axis.   |
|   | <b>Positioning Gear Operation</b>  |   | A gear motion with the specified gear ratio and sync position is performed between a master axis and slave axis.                     |  |
|   | <b>Ending Gear Operation</b>   |   | The specified gear motion or positioning gear motion is ended.   |  |
|   | <b>Synchronous Positioning</b>   |   | Positioning is performed in sync with a specified master axis.   |  |
|   | <b>Master Axis Phase Shift</b>   |   | The phase of a master axis in synchronized control is shifted.   |  |
|   | Single-axis Manual Operation   | <b>Combining Axes</b>   | The command positions of two axes are added or subtracted and the result is output as the command position.                          |  |
|   |  | <b>Powering the Servo</b>   | The Servo in the Servo Drive is turned ON to enable axis motion.   |  |
|   | Auxiliary Functions for Single-axis Control                                      | <b>Jogging</b>  | An axis is jogged at a specified target velocity.  |  |
|   |  | <b>Resetting Axis Errors</b>  | Axes errors are cleared.   |  |
|   |  | <b>Homing</b>   | A motor is operated and the limit signals, home proximity signal, and home signal are used to define home.                           |  |
|   |  | <b>Homing with parameter</b>  | Specifying the parameter, a motor is operated and the limit signals, home proximity signal, and home signal are used to define home. |  |
|   |  | <b>High-speed Homing</b>  | Positioning is performed for an absolute target position of 0 to return to home.   |  |
|   |  | <b>Stopping</b>   | An axis is decelerated to a stop at the specified rate.  |  |
|   |  | <b>Immediately Stopping</b>   | An axis is stopped immediately.  |  |
|   |  | <b>Setting Override Factors</b>   | The target velocity of an axis can be changed.   |  |
| <b>Changing the Current Position</b>    |  | The command current position or actual current position of an axis can be changed to any position.  |  |  |
| <b>Enabling External Latches</b>        |  | The position of an axis is recorded when a trigger occurs.  |  |  |
| <b>Disabling External Latches</b>       |  | The current latch is disabled.  |  |  |
| <b>Zone Monitoring</b>                  |  | You can monitor the command position or actual position of an axis to see when it is within a specified range (zone).                     |  |  |
| <b>Enabling digital cam switches</b>    |  | You can turn a digital output ON and OFF according to the position of an axis.  |  |  |
| <b>Monitoring Axis Following Error</b>  |  | You can monitor whether the difference between the command positions or actual positions of two specified axes exceeds a threshold value. |  |  |
| <b>Resetting the Following Error</b>    |  | The error between the command current position and actual current position is set to 0.   |  |  |
| <b>Torque Limit</b>                     |  | The torque control function of the Servo Drive can be enabled or disabled and the torque limits can be set to control the output torque.  |  |  |
| <b>Slave Axis Position Compensation</b> |  | This function compensates the position of the slave axis currently in synchronized control.   |  |  |
| <b>Cam monitor</b>                      | Outputs the specified offset position for the slave axis in synchronous control. |   |  |  |
| <b>Start velocity</b>                   | You can set the initial velocity when axis motion starts.                        |   |  |  |

| Item           |                       |  | NX701-□□□□   |   |   |
|----------------|-----------------------|--|--|---|---|
| Motion Control | Axes Groups           | Multi-axes Coordinated Control                               | Absolute Linear Interpolation  | Linear interpolation is performed to a specified absolute position.   |   |
|                |                       |  | Relative Linear Interpolation  | Linear interpolation is performed to a specified relative position.   |   |
|                |                       |  | Circular 2D Interpolation  | Circular interpolation is performed for two axes.   |   |
|                |                       |  | Axes Group Cyclic Synchronous Absolute Positioning   | A positioning command is output each control period in Position Control Mode.   |   |
|                |                       | Auxiliary Functions for Multi-axes Coordinated Control       | Resetting Axes Group Errors  | Axes group errors and axis errors are cleared.  |   |
|                |                       |  | Enabling Axes Groups   | Motion of an axes group is enabled.   |   |
|                |                       |  | Disabling Axes Groups  | Motion of an axes group is disabled.  |   |
|                |                       |  | Stopping Axes Groups   | All axes in interpolated motion are decelerated to a stop.  |   |
|                |                       |  | Immediately Stopping Axes Groups   | All axes in interpolated motion are stopped immediately.  |   |
|                |                       |  | Setting Axes Group Override Factors  | The blended target velocity is changed during interpolated motion.  |   |
|                |                       |  | Reading Axes Group Positions   | The command current positions and actual current positions of an axes group can be read.  |   |
|                |                       |  | Changing the Axes in an Axes Group   | The Composition Axes parameter in the axes group parameters can be overwritten temporarily.   |   |
|                |                       | Common Items   | Cams   | Setting Cam Table Properties  | The end point index of the cam table that is specified in the input parameter is changed.                 |
|                |                       |  |  | Saving Cam Tables   | The cam table that is specified with the input parameter is saved in non-volatile memory in the CPU Unit. |
|                | Generating cam tables |  |  | The cam table that is specified with the input parameter is generated from the cam property and cam node.   |   |
|                | Parameters            |  | Writing MC Settings  | Some of the axis parameters or axes group parameters are overwritten temporarily.   |   |
|                | Auxiliary Functions   | Count Modes  | Changing axis parameters   | You can access and change the axis parameters from the user program.  |   |
|                |                       |  | Count Modes  | You can select either Linear Mode (finite length) or Rotary Mode (infinite length).   |   |
|                |                       | Unit Conversions   | Automatic Acceleration/Deceleration Control  | Jerk is set for the acceleration/deceleration curve for an axis motion or axes group motion.  |   |
|                |                       |  | Changing the Acceleration and Deceleration Rates   | You can change the acceleration or deceleration rate even during acceleration or deceleration.  |   |
|                |                       | In-position Check  |  | You can set an in-position range and in-position check time to confirm when positioning is completed.   |   |
|                |                       | Stop Method  |  | You can set the stop method to the immediate stop input signal or limit input signal.   |   |
|                |                       | Re-execution of Motion Control Instructions                  |  | You can change the input variables for a motion control instruction during execution and execute the instruction again to change the target values during operation.                            |   |
|                |                       | Multi-execution of Motion Control Instructions (Buffer Mode) |  | You can specify when to start execution and how to connect the velocities between operations when another motion control instruction is executed during operation.                              |   |
|                |                       | Continuous Axes Group Motions (Transition Mode)              |  | You can specify the Transition Mode for multi-execution of instructions for axes group operation.   |   |
|                |                       | Monitoring Functions   | Software Limits  |   | Software limits are set for each axis.  |
|                |                       |  | Following Error  |   | The error between the command current value and the actual current value is monitored for an axis.        |
|                |                       |  | Velocity, Acceleration Rate, Deceleration Rate, Torque, Interpolation Velocity, Interpolation Acceleration Rate, And Interpolation Deceleration Rate |   | You can set and monitor warning values for each axis and each axes group.                                 |
|                |                       | Absolute Encoder Support                                     |  | You can use an OMRON G5-Series or 1S-Series Servomotor with an Absolute Encoder to eliminate the need to perform homing at startup.   |   |
|                |                       | Input signal logic inversion                                 |  | You can inverse the logic of immediate stop input signal, positive limit input signal, negative limit input signal, or home proximity input signal.   |   |
|                |                       | External Interface Signals                                   |  | The Servo Drive input signals listed on the right are used. Home signal, home proximity signal, positive limit signal, negative limit signal, immediate stop signal, and interrupt input signal |   |

## NX7

|                        |   | Item                               | NX701-□□□□  |  |
|------------------------|---|------------------------------------|---|--|
| Unit (I/O) Management  | EtherCAT Slaves                         | Maximum Number of Slaves           | 512   |  |
|                        | C-J-Series Units                        | Basic I/O Units                    | Load Short-circuit Protection and I/O Disconnection Detection |  |
| Communications         | Built-in EtherNet/IP port Internal Port | Communications protocol            |   | TCP/IP, UDP/IP   |
|                        |   | CIP Communications Service         | Tag Data Links  | Programless cyclic data exchange is performed with the devices on the EtherNet/IP network.   |
|                        |   |                                    | Message Communications  | CIP commands are sent to or received from the devices on the EtherNet/IP network.  |
|                        |   | TCP/IP functions                   | CIDR  | The function which performs IP address allocations without using a class (class A to C) of IP address.   |
|                        |   |                                    | IP Forwarding   | The function which forward IP packets between interfaces.  |
|                        |   | TCP/IP Applications                | Socket Services   | Data is sent to and received from any node on Ethernet using the UDP or TCP protocol. Socket communications instructions are used.   |
|                        |   |                                    | FTP client  | File can be read from or written to computers at other Ethernet nodes from the CPU Unit. FTP client communications instructions are used.  |
|                        |   |                                    | FTP Server  | Files can be read from or written to the SD Memory Card in the CPU Unit from computers at other Ethernet nodes.  |
|                        |   |                                    | Automatic Clock Adjustment                                    | Clock information is read from the NTP server at the specified time or at a specified interval after the power supply to the CPU Unit is turned ON. The internal clock time in the CPU Unit is updated with the read time.                               |
|                        |   | OPC UA                             | Server Function   | Functions to respond to requests from clients on the OPC UA network  |
|                        | EtherCAT Port                           | Supported Services                 | Process Data Communications                                   | Control information is exchanged in cyclic communications between the EtherCAT master and slaves.  |
|                        |   |                                    | SDO Communications  | A communications method to exchange control information in noncyclic event communications between EtherCAT master and slaves. This communications method is defined by CoE.  |
|                        |   | Network Scanning                   |   | Information is read from connected slave devices and the slave configuration is automatically generated.   |
|                        |   | DC (Distributed Clock)             |   | Time is synchronized by sharing the EtherCAT system time among all EtherCAT devices (including the master).  |
|                        |   | Packet Monitoring                  |   | The frames that are sent by the master and the frames that are received by the master can be saved. The data that is saved can be viewed with WireShark or other applications.   |
|                        |   | Enable/disable Settings for Slaves |   | The slaves can be enabled or disabled as communications targets.   |
|                        |   | Disconnecting/Connecting Slaves    |   | Temporarily disconnects a slave from the EtherCAT network for maintenance, such as for replacement of the slave, and then connects the slave again.  |
|                        |   | Supported Application Protocol     | CoE   | SDO messages of the CAN application can be sent to slaves via EtherCAT.  |
|                        | Communications Instructions             |                                    |   | The following instructions are supported.<br>CIP communications instructions, socket communications instructions, SDO message instructions, no-protocol communications instructions *2, FTP client instructions, and Modbus RTU protocol instructions *2 |
|                        | Operation Management                    | RUN Output Contacts                |   | The output on the Power Supply Unit turns ON in RUN mode.  |
| System Management      | Event Logs                              | Function                           |   | Events are recorded in the logs.   |
|                        |   | Maximum number of events           | System event log  | 2,048  |
|                        |   |                                    | Access event log  | 1,024  |
| User-defined event log | 1,024                                   |                                    |   |  |

\*2. Supported only by the CPU Units with unit version 1.11 or later.

| Item                                      |  |   | NX701-□□□□   |   |
|---|--|---|--|---|
| Debugging                                 | Online Editing   | Single  | Programs, function blocks, functions, and global variables can be changed online. Different operators can change different POU's across a network. |   |
|   | Forced Refreshing  |   | The user can force specific variables to TRUE or FALSE.  |   |
|   |  | Maximum Number of Forced Variables  | Device Variables for EtherCAT Slaves   | 64  |
|   | MC Test Run  |   | Motor operation and wiring can be checked from the Sysmac Studio.  |   |
|   | Synchronizing  |   | The project file in the Sysmac Studio and the data in the CPU Unit can be made the same when online.   |   |
|   | Differentiation monitoring                                   |   | Rising/falling edge of contacts can be monitored.  |   |
|   |  | Maximum number of contacts  |  | 8   |
|   | Data Tracing   | Types   | Single Triggered Trace   | When the trigger condition is met, the specified number of samples are taken and then tracing stops automatically.  |
|   |  |   | Continuous Trace   | Data tracing is executed continuously and the trace data is collected by the Sysmac Studio.   |
|   |  | Maximum Number of Simultaneous Data Trace   |  | 4   |
|   |  | Maximum Number of Records   |  | 10,000  |
|   |  | Sampling  | Maximum Number of Sampled Variables  | 192 variables   |
|   |  | Timing of Sampling  |  | Sampling is performed for the specified task period, at the specified time, or when a sampling instruction is executed.   |
|   |  | Triggered Traces  |  | Trigger conditions are set to record data before and after an event.  |
|   |  |   | Trigger Conditions   | When BOOL variable changes to TRUE or FALSE Comparison of non-BOOL variable with a constant<br>Comparison Method: Equals (=), Greater than (>), Greater than or equals (≥), Less Than (<), Less than or equals (≤), Not equal (≠) |
|   |  | Delay   | Trigger position setting: A slider is used to set the percentage of sampling before and after the trigger condition is met.                        |   |
| Simulation                                |  | The operation of the CPU Unit is emulated in the Sysmac Studio.   |  |   |
| Reliability Functions                     | Self-diagnosis   | Controller Errors   | Levels   | Major fault, partial fault, minor fault, observation, and information   |
|   |  | User-defined errors   |  | User-defined errors are registered in advance and then records are created by executing instructions.   |
|   |  | Levels  |  | 8 levels  |
| Security                                  | Protecting Software Assets and Preventing Operating Mistakes | CPU Unit Names and Serial IDs   |  | When going online to a CPU Unit from the Sysmac Studio, the CPU Unit name in the project is compared to the name of the CPU Unit being connected to.  |
|   |  | Protection  | User Program Transfer with No Restoration Information  | You can prevent reading data in the CPU Unit from the Sysmac Studio.  |
|   |  |   | CPU Unit Write Protection  | You can prevent writing data to the CPU Unit from the Sysmac Studio or SD Memory Card.  |
|   |  |   | Overall Project File Protection  | You can use passwords to protect .smc files from unauthorized opening on the Sysmac Studio.   |
|   |  |   | Data Protection  | You can use passwords to protect POU's on the Sysmac Studio.  |
|   |  | Verification of Operation Authority   |  | Online operations can be restricted by operation rights to prevent damage to equipment or injuries that may be caused by operating mistakes.  |
|   |  |   | Number of Groups   |   |
| Verification of User Program Execution ID |  | The user program cannot be executed without entering a user program execution ID from the Sysmac Studio for the specific hardware (CPU Unit). |  |   |
| SD Memory Card Functions                  | Storage Type   |   | SD Memory Card, SDHC Memory Card   |   |
|   | Application  | Automatic transfer from SD Memory Card  | The data in the autoload folder on an SD Memory Card is automatically loaded when the power supply to the Controller is turned ON.                 |   |
|   |  | Transfer program from SD Memory Card *2   | The user program on an SD Memory Card is loaded when the user changes system-defined variable to TRUE.   |   |
|   |  | SD Memory Card Operation Instructions   | You can access SD Memory Cards from instructions in the user program.  |   |
|   |  | File Operations from the Sysmac Studio  | You can perform file operations for Controller files in the SD Memory Card and read/write standard document files on the computer.                 |   |
|   |  | SD Memory Card Life Expiration Detection  | Notification of the expiration of the life of the SD Memory Card is provided in a systemdefined variable and event log.                            |   |

\*2. Supported only by the CPU Units with unit version 1.11 or later.

## NX7

| Item                                      |                                 |   | NX701-□□□□  |   |
|---|---------------------------------|---|---|---|
| Backup functions                          | SD Memory Card backup functions | Operation   | Using front switch  | You can use front switch to backup, compare, or restore data.   |
|   |                                 |   | Using system-defined variables  | You can use system-defined variables to backup, compare, or restore data. *3  |
|   |                                 |   | Memory Card Operations Dialog Box on Sysmac Studio  | Backup and verification operations can be performed from the SD Memory Card Operations Dialog Box on the Sysmac Studio. |
|   |                                 | Using instruction                                 | Backup operation can be performed by using instruction.   |   |
|   | Protection                      | Prohibiting backing up data to the SD Memory Card | Prohibit SD Memory Card backup functions.   |   |
| Sysmac Studio Controller backup functions |                                 |   | Backup, restore, and verification operations for Units can be performed from the Sysmac Studio. |   |

\*3. Restore is supported with unit version 1.14 or later.

## Function Specifications of Database Connection CPU Units

Besides functions of the NX701-□□□□, functions supported by the NX701-1□20 is as follows.

| Item   |   | Description  |  |
|--|---|--|--|
|  |   | NX701-1□20   |  |
| <b>Supported port</b>  |   | Built-in EtherNet/IP port  |  |
| <b>Supported DB *1*2</b>   |   | Microsoft Corporation: SQL Server 2012/2014/2016/2017/2019<br>Oracle Corporation: Oracle Database 11g /12c/18c/19c<br>MySQL Community Edition 5.6/5.7/8.0 *3<br>International Business Machines Corporation (IBM): DB2 for Linux, UNIX and Windows 9.7/10.1/10.5/11.1<br>Firebird Foundation Incorporated: Firebird 2.5<br>The PostgreSQL Global Development Group: PostgreSQL 9.4/9.5/9.6/10/11/12/13 |  |
| <b>Number of DB Connections<br/>(Number of databases that can be connected at the same time)</b> |   | 3 connections max. *4  |  |
| Instruction  | <b>Supported operations</b>                                       | The following operations can be performed by executing DB Connection Instructions in the NJ/NX-series CPU Units.<br>Inserting records (INSERT), Updating records (UPDATE), Retrieving records (SELECT), Deleting records (DELETE), Execute Stored Procedure *5, and Execute Batch Insert *5  |  |
|  | <b>Max. number of instructions for simultaneous execution</b>     | 32   |  |
|  | <b>Max. number of columns in an INSERT operation</b>              | SQL Server: 1,024<br>Oracle: 1,000<br>DB2: 1,000<br>MySQL: 1,000<br>Firebird: 1,000<br>PostgreSQL: 1,000   |  |
|  | <b>Max. number of columns in an UPDATE operation</b>              | SQL Server: 1,024<br>Oracle: 1,000<br>DB2: 1,000<br>MySQL: 1,000<br>Firebird: 1,000<br>PostgreSQL: 1,000   |  |
|  | <b>Max. number of columns in a SELECT operation</b>               | SQL Server: 1,024<br>Oracle: 1,000<br>DB2: 1,000<br>MySQL: 1,000<br>Firebird: 1,000<br>PostgreSQL: 1,000   |  |
|  | <b>Max. number of records in the output of a SELECT operation</b> | 65,535 elements, 4 MB  |  |
|  | <b>Stored procedure call *5</b>                                   | <b>Supported databases</b>   | <ul style="list-style-type: none"> <li>• SQL Server</li> <li>• Oracle Database</li> <li>• MySQL Community Edition</li> <li>• PostgreSQL</li> </ul> |
|  |   | <b>Argument (Sum of IN, OUT and INOUT)</b>   | Up to 256 variables *6   |
|  |   | <b>Return value</b>  | One variable   |
|  |   | <b>Result set</b>  | Supported  |
|  | <b>Batch insert execution *5</b>                                  | <b>Supported databases</b>   | <ul style="list-style-type: none"> <li>• SQL Server</li> <li>• Oracle Database</li> <li>• MySQL Community Edition</li> <li>• PostgreSQL</li> </ul> |
|  |   | <b>Supported data size</b>   | Less than 1,000 columns and upper limit (8 MB) of structure variable size or less *7   |
|  |   | <b>Spool function</b>  | Not supported  |
| <b>Max. number of DB Map Variables for which a mapping can be connected</b>                      |   | SQL Server: 60<br>Oracle: 30<br>DB2: 30<br>MySQL: 30<br>Firebird: 15<br>PostgreSQL: 30 *8  |  |
| <b>Run mode of the DB Connection Service</b>   |   | Operation Mode or Test Mode <ul style="list-style-type: none"> <li>• Operation Mode: When each instruction is executed, the service actually accesses the DB.</li> <li>• Test Mode: When each instruction is executed, the service ends the instruction normally without accessing the DB actually.</li> </ul>   |  |
| <b>Spool function</b>  |   | Used to store SQL statements when an error occurred and resend the statements when the communications are recovered from the error.  |  |
| <b>Spool capacity</b>  |   | 2 MB *9  |  |
| <b>Operation Log function</b>  |   | The following three types of logs can be recorded. <ul style="list-style-type: none"> <li>• Execution Log: Log for tracing the executions of the DB Connection Service.</li> <li>• Debug Log: Detailed log for SQL statement executions of the DB Connection Service.</li> <li>• SQL Execution Failure Log: Log for execution failures of SQL statements in the DB.</li> </ul>                         |  |
| <b>DB Connection Service shutdown function</b>   |   | Used to shut down the DB Connection Service after automatically saving the Operation Log files into the SD Memory Card.  |  |
| <b>Encrypted Communication</b>   | <b>Supported databases</b>  | <ul style="list-style-type: none"> <li>• SQL Server</li> <li>• Oracle Database</li> <li>• MySQL Community Edition</li> <li>• PostgreSQL</li> </ul>   |  |
|  | <b>TLS Ver.</b>   | TLS 1.2  |  |

## NX7

- 
- \*1. SQL Server 2014, Oracle Database 12c and PostgreSQL 9.4 are supported by the DB Connection Service Version 1.02 or higher. SQL Server 2016, My SQL 5.7, DB2 11.1 and Postgre SQL 9.5/9.6 are supported by the DB Connection Service Version 1.03 or higher. SQL Server 2017 is supported by the DB Connection Service Version 1.04 or higher. Oracle Database 18c, MySQL Community Edition 8.0 and PostgreSQL 10 are supported by the DB Connection Service Version 2.00 or higher. You cannot use Oracle 10g with the DB Connection Service version 2.00 or higher. SQL Server 2019, Oracle Database 19c and PostgreSQL 11/12/13 are supported by the DB Connection Service Version 2.01 or higher.
  - \*2. Connection to the DB on the cloud is not supported.
  - \*3. The supported storage engines of the DB are InnoDB and MyISAM.
  - \*4. When two or more DB Connections are established, the operation cannot be guaranteed if you set different database types for the connections.
  - \*5. The function is available for the DB Connection Service Version 2.00 or higher.
  - \*6. Depends on members of a structure.
  - \*7. Constrained by the memory capacity for variables. See the specifications for the memory capacity for variables.
  - \*8. Even if the number of DB Map Variables has not reached the upper limit, the total number of members of structures used as data type of DB Map Variables is 10,000 members max.
  - \*9. Refer to "NJ/NX-series Database Connection CPU Units User's Manual(W527)" for the information.

**Note:** The extended support for databases has ended for the following DB versions.  
Please consider replacing the current database with a new version.

| Item   | Discription |
|--|-------------|
| Microsoft Corporation: SQL Server  | 2008/2008R2 |
| Oracle Corporation: Oracle Database  | 10g         |
| Oracle Corporation: MySQL Community Edition  | 5.1/5.5     |
| International Business Machines Corporation (IBM): DB2 for Linux, UNIX and Windows | 9.5         |
| Firebird Foundation Incorporated: Firebird   | 2.1         |
| The PostgreSQL Global Development Group: PostgreSQL                                | 9.2/9.3     |

## Version Information

### Unit Versions and Programming Devices (NX701 CPU Units)

Refer to "NX-series CPU Unit Hardware User's Manual (W535)".

### Functions That Were Added or Changed for Each Unit Version and Sysmac Studio version

Refer to "NX-series CPU Unit Hardware User's Manual (W535)".

# Components and Functions

## CPU Unit

NX701-□□□□

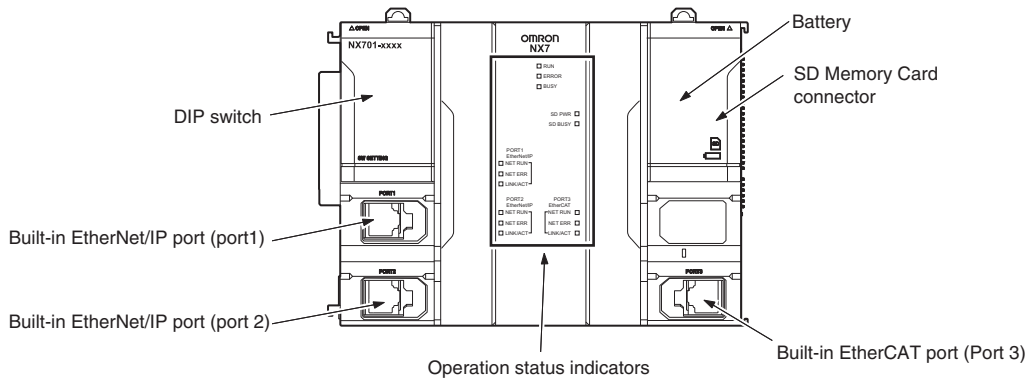

## Power Supply Unit

NX-PA9001

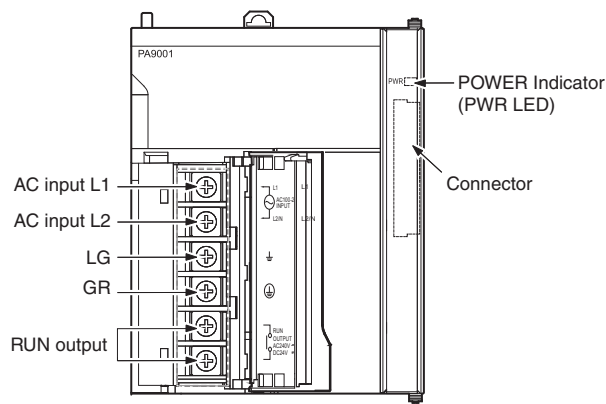

NX-PD7001

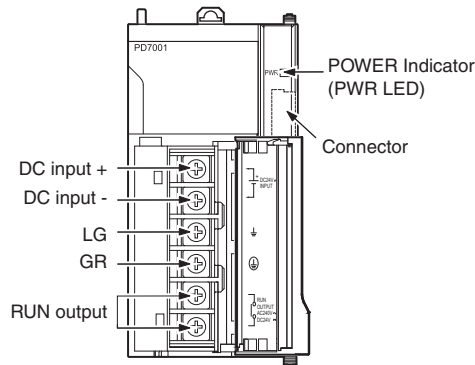

# NX7

## Dimensions

(Unit: mm)

### CPU Units

NX701-□□□□

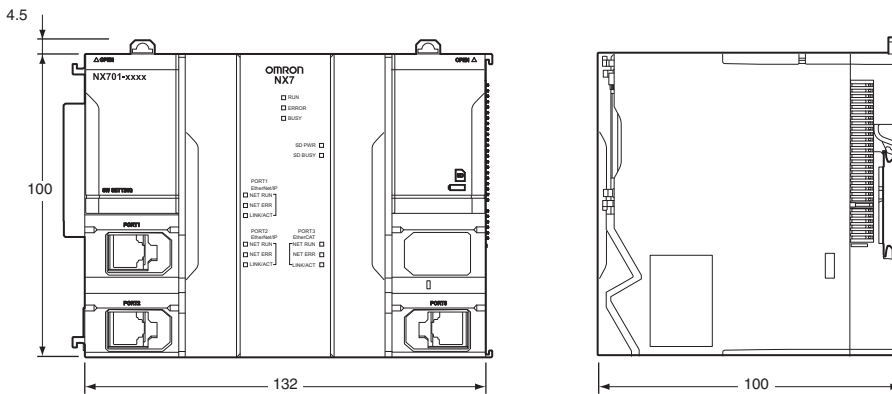

When a cable is connected (such as a communications cable)

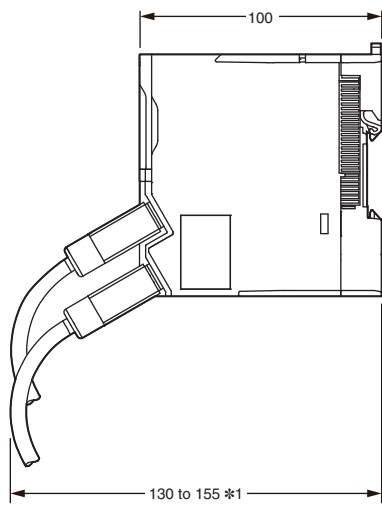

\*1. This is the dimension from the back of the Unit to the communications cables.  
 130 mm: When an MPS588-C Connector is used.  
 155 mm: When an XS6G-T421-1 Connector is used.

### Power Supply Units

NX-PA9001

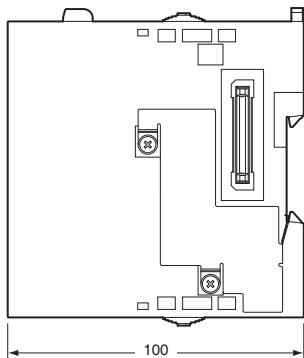
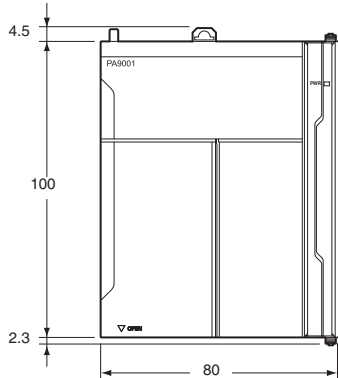

NX-PD7001

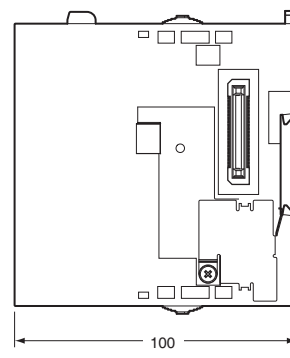
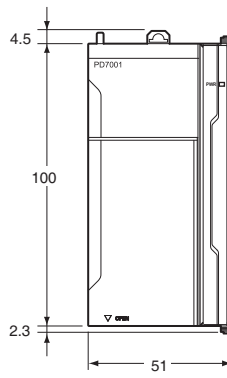

### End Cover

(included with CPU Units)

NX-END01

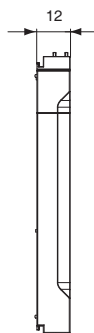

## Related Manuals

| Cat. No. | Model number   | Manual  | Application   | Description  |
|----------|--|---|---|--|
| W514     | NX701-□□□□<br>NX1P2-□□□□<br>NJ501-□□□□<br>NJ301-□□□□<br>NJ101-□□□□               | NJ/NX-series Startup Guide (Motion Control)                     | Using the motion control function module of the NJ/NX-series for the first time   | The startup procedures for setting axis parameters and performing simple one-axis positioning and two-axis linear interpolation with an NJ/NX-series CPU Unit and the operating instructions for the Sysmac Studio are described.  |
| W535     | NX701-□□□□   | NX-series CPU Unit Hardware User's Manual                       | Learning the basic specifications of the NX701-series CPU Units, including introductory information, designing, installation, and maintenance. Mainly hardware information is provided. | An introduction to the entire NX701-series system is provided along with the following information on a Controller built with a CPU Unit. <ul style="list-style-type: none"> <li>• Features and system configuration</li> <li>• Introduction</li> <li>• Part names and functions</li> <li>• General specifications</li> <li>• Installation and wiring</li> <li>• Maintenance and inspection</li> </ul> |
| W501     | NX701-□□□□<br>NX102-□□□□<br>NX1P2-□□□□<br>NJ501-□□□□<br>NJ301-□□□□<br>NJ101-□□□□ | NJ/NX-series CPU Unit Software User's Manual                    | Learning how to program and set up an NJ/NX-series CPU Unit. Mainly software information is provided.   | The following information is provided on a Controller built with an NJ/NX-series CPU Unit. <ul style="list-style-type: none"> <li>• CPU Unit operation</li> <li>• CPU Unit features</li> <li>• Initial settings</li> <li>• Programming language specifications and programming with the IEC 61131-3 standard.</li> </ul>   |
| W507     | NX701-□□□□<br>NX102-□□□□<br>NX1P2-□□□□<br>NJ501-□□□□<br>NJ301-□□□□<br>NJ101-□□□□ | NJ/NX-series CPU Unit Motion Control User's Manual              | Learning about motion control settings and programming concepts   | The settings and operation of the CPU Unit and programming concepts for motion control are described.  |
| W505     | NX701-□□□□<br>NX102-□□□□<br>NX1P2-□□□□<br>NJ501-□□□□<br>NJ301-□□□□<br>NJ101-□□□□ | NJ/NX-series CPU Unit Built-in EtherCAT Port User's Manual      | Using the built-in EtherCAT port on an NJ/NX-series CPU Unit  | Information on the built-in EtherCAT port is provided. This manual provides an introduction and provides information on the configuration, features, and setup.  |
| W527     | NX701-□□□20<br>NX102-□□□20<br>NJ501-□□□20<br>NJ101-□□□20                         | NJ/NX-series Database Connection CPU Units User's Manual        | Learning about the functions and application procedures of the NJ/NX-series DB Connection function.   | Describes the functions and application procedures of the NJ/NX-series DB Connection function.   |
| W506     | NX701-□□□□<br>NX102-□□□□<br>NX1P2-□□□□<br>NJ501-□□□□<br>NJ301-□□□□<br>NJ101-□□□□ | NJ/NX-series CPU Unit Built-in EtherNet/IP Port User's Manual   | Using the built-in EtherNet/IP port on an NJ/NX-series CPU Unit   | Information on the built-in EtherNet/IP port is provided. Information is provided on the basic setup, tag data links, FINS communications (non-disclosure), and other features.  |
| W588     | NX102-□□□□<br>NX701-1□□□<br>NJ501-1□□0   | NJ/NX-series CPU Unit OPC UA User's Manual                      | Using the OPC UA.   | Describes the OPC UA.  |
| W502     | NX701-□□□□<br>NX102-□□□□<br>NX1P2-□□□□<br>NJ501-□□□□<br>NJ301-□□□□<br>NJ101-□□□□ | NJ/NX-series Instructions Reference Manual                      | Learning about the specifications of the instruction set that is provided by OMRON  | The instructions in the instruction set (IEC 61131-3 specifications) are described.  |
| W508     | NX701-□□□□<br>NX102-□□□□<br>NX1P2-□□□□<br>NJ501-□□□□<br>NJ301-□□□□<br>NJ101-□□□□ | NJ/NX-series Motion Control Instructions Reference Manual       | Learning about the specifications of the motion control instructions that are provided by OMRON   | The motion control instructions are described.   |
| W503     | NX701-□□□□<br>NX102-□□□□<br>NX1P2-□□□□<br>NJ501-□□□□<br>NJ301-□□□□<br>NJ101-□□□□ | NJ/NX-series Troubleshooting Manual                             | Learning about the errors that may be detected in an NJ/NX-series Controller.   | Concepts on managing errors that may be detected in an NJ/NX-series Controller and information on individual errors are described.   |
| W504     | SYSMAC-SE2□□□□   | Sysmac Studio Version 1 Operation Manual                        | Learning about the operating procedures and functions of the Sysmac Studio.   | Describes the operating procedures of the Sysmac Studio.   |
| W589     | SYSMACSE2□□□□<br>SYSMAC-TA4□□□□  | Sysmac Studio Project Version Control Function Operation Manual | Learning the overview of the Sysmac Studio project version control function and how to use it.  | The manual outlines the Sysmac Studio project version control function, and describes how to install, basic operation, and how to operate its major functions.   |

# NX7

---

Sysmac is a trademark or registered trademark of OMRON Corporation in Japan and other countries for OMRON factory automation products.  
Microsoft, Windows, Windows Vista and SQL Server are registered trademarks of Microsoft Corporation in the United States and other countries.  
Oracle, Oracle Database and MySQL are trademarks or registered trademarks of Oracle Corporation and/or its affiliates in the United States and other countries.  
IBM and DB2 are trademarks or registered trademarks of International Business Machines Corp., registered in the United States and other countries.  
EtherCAT® is a registered trademark of Beckhoff Automation GmbH for their patented technology.  
EtherNet/IP™ and DeviceNet™ are trademarks of ODVA.  
OPC UA is trademark of the OPC Foundation.  
This product includes software developed by the OpenSSL Project for use in the OpenSSL Toolkit. (<http://www.openssl.org/>)  
This product includes cryptographic software written by Eric Young ([eay@cryptsoft.com](mailto:eay@cryptsoft.com)).  
Other company names and product names in this document are the trademarks or registered trademarks of their respective companies.

# Terms and Conditions Agreement

## **Read and understand this catalog.**

Please read and understand this catalog before purchasing the products. Please consult your OMRON representative if you have any questions or comments.

## **Warranties.**

(a) Exclusive Warranty. Omron's exclusive warranty is that the Products will be free from defects in materials and workmanship for a period of twelve months from the date of sale by Omron (or such other period expressed in writing by Omron). Omron disclaims all other warranties, express or implied.

(b) Limitations. OMRON MAKES NO WARRANTY OR REPRESENTATION, EXPRESS OR IMPLIED, ABOUT NON-INFRINGEMENT, MERCHANTABILITY OR FITNESS FOR A PARTICULAR PURPOSE OF THE PRODUCTS. BUYER ACKNOWLEDGES THAT IT ALONE HAS DETERMINED THAT THE PRODUCTS WILL SUITABLY MEET THE REQUIREMENTS OF THEIR INTENDED USE.

Omron further disclaims all warranties and responsibility of any type for claims or expenses based on infringement by the Products or otherwise of any intellectual property right. (c) Buyer Remedy. Omron's sole obligation hereunder shall be, at Omron's election, to (i) replace (in the form originally shipped with Buyer responsible for labor charges for removal or replacement thereof) the non-complying Product, (ii) repair the non-complying Product, or (iii) repay or credit Buyer an amount equal to the purchase price of the non-complying Product; provided that in no event shall Omron be responsible for warranty, repair, indemnity or any other claims or expenses regarding the Products unless Omron's analysis confirms that the Products were properly handled, stored, installed and maintained and not subject to contamination, abuse, misuse or inappropriate modification. Return of any Products by Buyer must be approved in writing by Omron before shipment. Omron Companies shall not be liable for the suitability or unsuitability or the results from the use of Products in combination with any electrical or electronic components, circuits, system assemblies or any other materials or substances or environments. Any advice, recommendations or information given orally or in writing, are not to be construed as an amendment or addition to the above warranty.

See <http://www.omron.com/global/> or contact your Omron representative for published information.

## **Limitation on Liability; Etc.**

OMRON COMPANIES SHALL NOT BE LIABLE FOR SPECIAL, INDIRECT, INCIDENTAL, OR CONSEQUENTIAL DAMAGES, LOSS OF PROFITS OR PRODUCTION OR COMMERCIAL LOSS IN ANY WAY CONNECTED WITH THE PRODUCTS, WHETHER SUCH CLAIM IS BASED IN CONTRACT, WARRANTY, NEGLIGENCE OR STRICT LIABILITY.

Further, in no event shall liability of Omron Companies exceed the individual price of the Product on which liability is asserted.

## **Suitability of Use.**

Omron Companies shall not be responsible for conformity with any standards, codes or regulations which apply to the combination of the Product in the Buyer's application or use of the Product. At Buyer's request, Omron will provide applicable third party certification documents identifying ratings and limitations of use which apply to the Product. This information by itself is not sufficient for a complete determination of the suitability of the Product in combination with the end product, machine, system, or other application or use. Buyer shall be solely responsible for determining appropriateness of the particular Product with respect to Buyer's application, product or system. Buyer shall take application responsibility in all cases.

NEVER USE THE PRODUCT FOR AN APPLICATION INVOLVING SERIOUS RISK TO LIFE OR PROPERTY OR IN LARGE QUANTITIES WITHOUT ENSURING THAT THE SYSTEM AS A WHOLE HAS BEEN DESIGNED TO ADDRESS THE RISKS, AND THAT THE OMRON PRODUCT(S) IS PROPERLY RATED AND INSTALLED FOR THE INTENDED USE WITHIN THE OVERALL EQUIPMENT OR SYSTEM.

## **Programmable Products.**

Omron Companies shall not be responsible for the user's programming of a programmable Product, or any consequence thereof.

## **Performance Data.**

Data presented in Omron Company websites, catalogs and other materials is provided as a guide for the user in determining suitability and does not constitute a warranty. It may represent the result of Omron's test conditions, and the user must correlate it to actual application requirements. Actual performance is subject to the Omron's Warranty and Limitations of Liability.

## **Change in Specifications.**

Product specifications and accessories may be changed at any time based on improvements and other reasons. It is our practice to change part numbers when published ratings or features are changed, or when significant construction changes are made. However, some specifications of the Product may be changed without any notice. When in doubt, special part numbers may be assigned to fix or establish key specifications for your application. Please consult with your Omron's representative at any time to confirm actual specifications of purchased Product.

## **Errors and Omissions.**

Information presented by Omron Companies has been checked and is believed to be accurate; however, no responsibility is assumed for clerical, typographical or proofreading errors or omissions.

**Note: Do not use this document to operate the Unit.**

**OMRON Corporation Industrial Automation Company**  
Kyoto, JAPAN

**Contact: [www.ia.omron.com](http://www.ia.omron.com)**

**Regional Headquarters**

**OMRON EUROPE B.V.**

Wegalaan 67-69, 2132 JD Hoofddorp  
The Netherlands  
Tel: (31)2356-81-300/Fax: (31)2356-81-388

**OMRON ELECTRONICS LLC**

2895 Greenspoint Parkway, Suite 200  
Hoffman Estates, IL 60169 U.S.A.  
Tel: (1) 847-843-7900/Fax: (1) 847-843-7787

**OMRON ASIA PACIFIC PTE. LTD.**

No. 438A Alexandra Road # 05-05/08 (Lobby 2),  
Alexandra Technopark,  
Singapore 119967  
Tel: (65) 6835-3011/Fax: (65) 6835-2711

**OMRON (CHINA) CO., LTD.**

Room 2211, Bank of China Tower,  
200 Yin Cheng Zhong Road,  
PuDong New Area, Shanghai, 200120, China  
Tel: (86) 21-5037-2222/Fax: (86) 21-5037-2200

**Authorized Distributor:**

© OMRON Corporation 2018-2021 All Rights Reserved.  
In the interest of product improvement,  
specifications are subject to change without notice.

**CSM\_8\_3**

**Cat. No. P141-E1-12**

1121 (1218)



**SCATTERGOOD  
& JOHNSON LTD**  
ELECTRICAL ENGINEERING & FLUID CONTROL DISTRIBUTORS

Est.1899

At Scattergood & Johnson Ltd, we pride ourselves on being a technical distributor to specialist industries.

Working with a range of quality product manufacturers across a number of specialist markets, we are not your average 'box shifter' - we are your technical and supply chain partner.

We fully support every product we sell - for free! Our internal team and external sales engineers can answer any product or application question, no matter the complexity.

Backing up this technical ability is a range of 50,000+ products available from stock for nationwide next day delivery (same day if required!), or you can collect what you need from any of our trade counters around the UK.

Select your specialist interest below to learn more about how we can help.

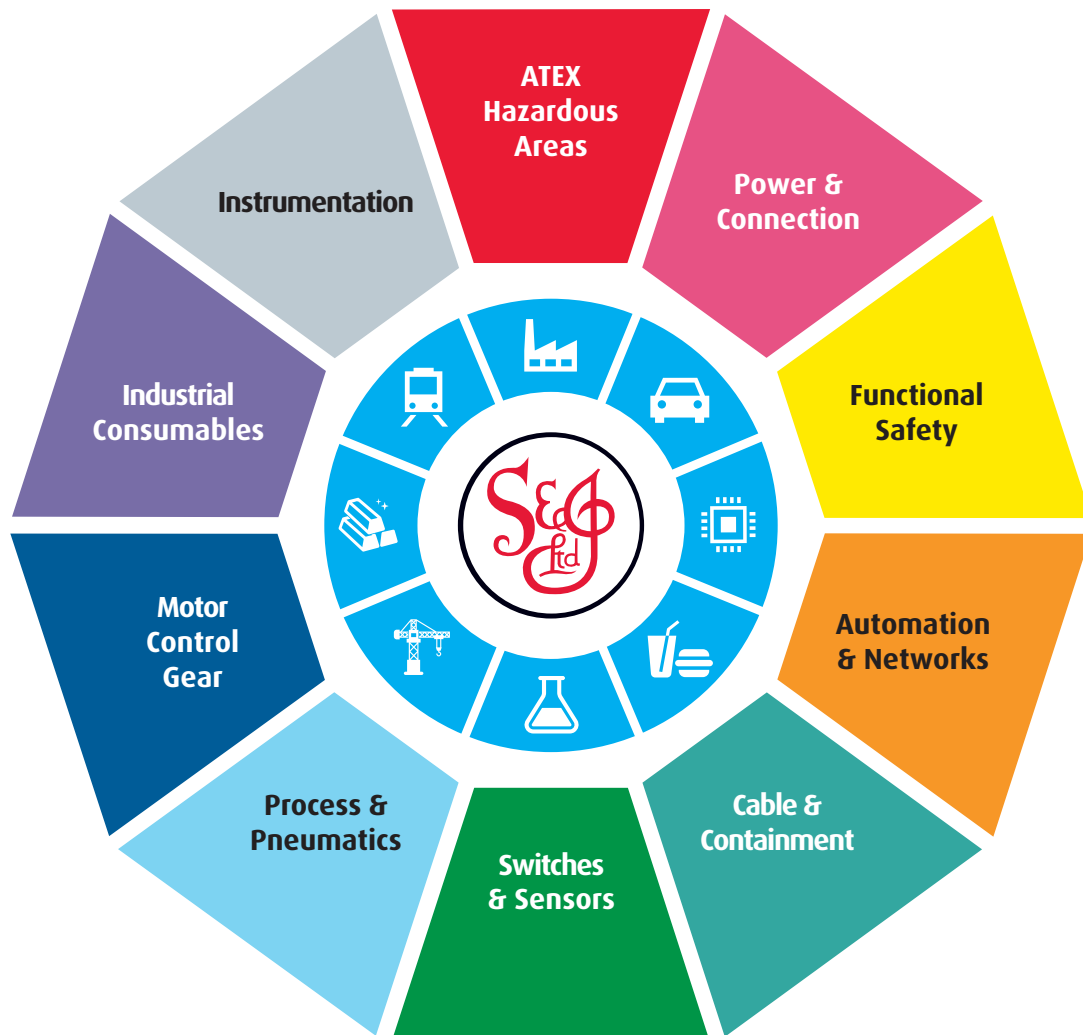

Online, In Branch and On the Road - Scattergood & Johnson Ltd, there when you need us.

**[www.scatts.co.uk](http://www.scatts.co.uk)**