

Technical Data Sheet

Die-Cast Aluminium Enclosed Switchgear Range

CDPD146
Issue 3

Die-Cast Aluminium Enclosed Switchgear

A range of die-cast aluminium enclosed isolation equipment with sealing up to IP66 available in Light Grey (RAL 7035) or Traffic Red (RAL3020) powder coated finish. These units can be placed in environments where resistance to impacts, moisture and dust/dirt are a concern. All units have a padlockable handle which allows for the insertion of up to three padlocks in the 'Off' position thus preventing the isolator being switched to the 'On' position. All units are interlocked in the ON position preventing the lid from being removed. The option to add a selection of auxiliary blocks providing additional contacts and a choice of Neutral assemblies increases the flexibility of the product range. Compliant to IEC / BS EN 60947-3.

Enclosures finished Red (RAL 3020) are available to order, please contact our Sales team for details. Replace 'G' in the Cat. No. to 'R' e.g. SDDR253N

'N' = switched neutral (Early make, late break) | 'NL' = Unswitched neutral | 'EB' = Early break auxiliary contacts
'X' = Bottom cable entries only. For top and bottom cable entries, replace 'X' with 'Y' in the Cat. No. E.g. SDDG402Y

Add suffix '/10' to the Cat. No. for padlocking in the 'On' position e.g. SDDG253/10

Add suffix '/CO' to a Cat. No. to include 1 set of Auxiliary contacts e.g. EDDG253/CO





EDDG Switch-Disconnectors (O-I)								
Image	Rating	Switch Type	Format	Cat. No.	Encl. Size	IP Rating	Encl. Material	Cable Entries
	20A	GX20	6P	EDDG206	C	IP66	Die cast aluminium alloy Light Grey RAL 7035	2 x M20 bottom only.
			6P+2EB Aux	EDDG206EB				
	25A	CS25	2P	EDDG252	C	IP66	Die cast aluminium alloy Light Grey RAL 7035	2 x M20 bottom only.
			3P	EDDG253				
			3P+N	EDDG253N				
			3P+NL	EDDG253NL				
	3P+2EB Aux	EDDG253EB						
	32A	CS32	2P	EDDG322	C	IP66	Die cast aluminium alloy Light Grey RAL 7035	2 x M20 bottom only.
			3P	EDDG323				
			3P+N	EDDG323N				
			3P+NL	EDDG323NL				
	3P+2EB Aux	EDDG323EB						
40A	CS40R	2P	EDDG402	C	IP66	Die cast aluminium alloy Light Grey RAL 7035	2 x M20 bottom only.	
		3P	EDDG403					
		3P+N	EDDG403N					
		3P+NL	EDDG403NL					
3P+2EB Aux	EDDG403EB							
	40A	GX40	6P	EDDG406	B	IP65	Die cast aluminium alloy Light Grey RAL 7035	2 x M25 & 1 x M20 bottom only.
			6P+2EB Aux	EDDG406EB				
	63A	CS63	2P	EDDG632	B	IP65	Die cast aluminium alloy Light Grey RAL 7035	2 x M25 & 1 x M20 bottom only.
			3P	EDDG633				
			3P+N	EDDG633N				
			3P+NL	EDDG633NL				
			3P+2EB Aux	EDDG633EB				
			6P	EDDG636				
	6P+2EB Aux	EDDG636EB						
	80A	CS80	2P	EDDG802	B	IP65	Die cast aluminium alloy Light Grey RAL 7035	2 x M25 & 1 x M20 bottom only.
			3P	EDDG803				
			3P+N	EDDG803N				
3P+NL		EDDG803NL						
GA080A		3P	EDDG803T					
		3P+N	EDDG803NT					
3P+NL	EDDG803NLT							

Technical Data Sheet

Die-Cast Aluminium Enclosed Switchgear Range

CDPD146
Issue 3

SDDG Switch-Disconnectors (O-I)									
Image	Rating	Interior Switch	Format	Cat. No.	Encl. Size	Encl. Material	IP Rating	Encl. Colour	Cable Entries
	20A	GX20	6P	SDDG206	A	Die cast aluminium alloy	IP66	Light Grey RAL 7035	2xM20 on bottom face
			6P+2EB Aux	SDDG206EB					
	25A	CS25	2P	SDDG252	A	Die cast aluminium alloy	IP66	Light Grey RAL 7035	2xM20 on bottom face
			3P	SDDG253					
			3P+NL	SDDG253NL					
			3P+N	SDDG253N					
			3P+2EB Aux	SDDG253EB					
	32A	CS32	2P	SDDG322	A	Die cast aluminium alloy	IP66	Light Grey RAL 7035	2xM20 on bottom face
			3P	SDDG323					
			3P+NL	SDDG323NL					
			3P+N	SDDG323N					
	40A	CS40R	2P	SDDG402X	A	Die cast aluminium alloy	IP66	Light Grey RAL 7035	2xM25 on bottom face
			3P	SDDG403X					
			3P+NL	SDDG403NLX					
			3P+N	SDDG403NX					
3P+2EB Aux			SDDG403EBX						
GX40		2P	SDDG402	B	Die cast aluminium alloy	IP65	Light Grey RAL 7035	2xM25 + 1xM20 on bottom face	
		3P	SDDG403						
		3P+NL	SDDG403NL						
		3P+N	SDDG403N						
		3P+2EB Aux	SDDG403EB						
63A		CS63	6P	SDDG406	B	Die cast aluminium alloy	IP65	Light Grey RAL 7035	2xM25 + 1xM20 on bottom face
			6P+2EB Aux	SDDG406EB					
			2P	SDDG632					
			3P	SDDG633					
	3P+NL		SDDG633NL						
	3P+N		SDDG633N						
80A	CS80	3P+2EB Aux	SDDG633EB	B	Die cast aluminium alloy	IP65	Light Grey RAL 7035	2xM25 + 1xM20 on bottom face	
		6P	SDDG636						
		6P+2EB Aux	SDDG636EB						
80A	CS80	3P	SDDG803	B	Die cast aluminium alloy	IP65	Light Grey RAL 7035	2xM32 + 1xM20 on bottom face	
		3P+NL	SDDG803NL						
		3P+N	SDDG803N						
Changeover Switch-Disconnectors (I-O-II)									
	20A	GX20	2P	SCODDG202	A	Die cast aluminium alloy	IP66	Light Grey RAL 7035	2xM20 on bottom face
			3P	SCODDG203					
			4P	SCODDG204					
	40A	GX40	2P	SCODDG402	B	Die cast aluminium alloy	IP65	Light Grey RAL 7035	2xM25 + 1xM20 on bottom face
			3P	SCODDG403					
			4P	SCODDG404					

Technical Data Sheet

Die-Cast Aluminium Enclosed Switchgear Range

CDPD146
Issue 3









Accessories

All of the accessories listed below can be retrofitted. One block can be fitted either side of the main assembly on all of the 3 pole Switch-Disconnecter interiors.

Description	Cat. No.
Auxiliary Contact- 2 Early Break	SAUX2EB
Auxiliary Contact- 1 N/O + 1 N/C	SAUXCO
80A Auxiliary Contact- 1 Early Break for GA switches	SAUX1EBL
80A Auxiliary Contact- 1 N/O + 1 N/C for GA switches	SAUXCOL
25A- 40A Compact Neutral (Unswitched)	SNLC40
63A Neutral (Unswitched)	SNL63
80A Neutral (Unswitched) for CS switches	SNL80
80A Neutral (Unswitched) for GA switches	SNL100L
25A Neutral (Switched)	SSP25
40A Neutral (Switched)	SSP40
63A Neutral (Switched)	SSP63
80A Neutral (Switched) for CS switches	SSP80
80A Neutral (Switched) for GA switches	SSP80L

Technical Specification

Data supplied against tests to IEC/BS EN 60947-3

Application	Unit	Category	20A	25A	32A	40A	63A	80A		
Interior Switch	-		GX20	CS25	CS32	GX40	CS40R	CS63	CS80	GA080A
Rated thermal current (I_{the})	A		20	25	32	40	40	63	80	80
Rated insulation voltage (U_i)	V		690	690	690	690	690	690	690	1000
Rated impulse voltage (U_{imp})	kV		6	6	6	6	6	6	6	8
Rated operational power (Single phase)	kW	230V- AC23	-	3.7	4.8	-	6.0	9.4	-	-
Rated operational power (Three phase)	kW	380/440- AC23	7.5	11	15	18.5	15	25	30	45
		500V- AC23	7.5	15	15	15	15	30	37	-
		690V- AC23	7.5	15	15	15	15	30	30	45
Rated short time withstand current (1 sec) (I_{cw})	A		250	500	600	800	600	1300	1400	2500
Max. fuse size for short circuit protection (gG Characteristic)	kA	10kA	20	35	35	40	40	80	80	80
		25kA	16	32	32	35	32	63	63	80
		50kA	-	32	32	-	32	63	63	80
Recommended connecting capacity	-	Terminal type								
	mm ²	Flexible cable	2.5 x 2	6	6	6 x 2	6	16	16	35
	mm ²	Rigid cable	2.5 x 2	10	10	10 x 2	10	25	25	35
	Nm	Tightening torque	1.0	1.2	1.2	1.0	1.2	1.2	1.2	1.2

Technical Data Sheet

Die-Cast Aluminium Enclosed Switchgear Range

CDPD146
Issue 3

Dimensions

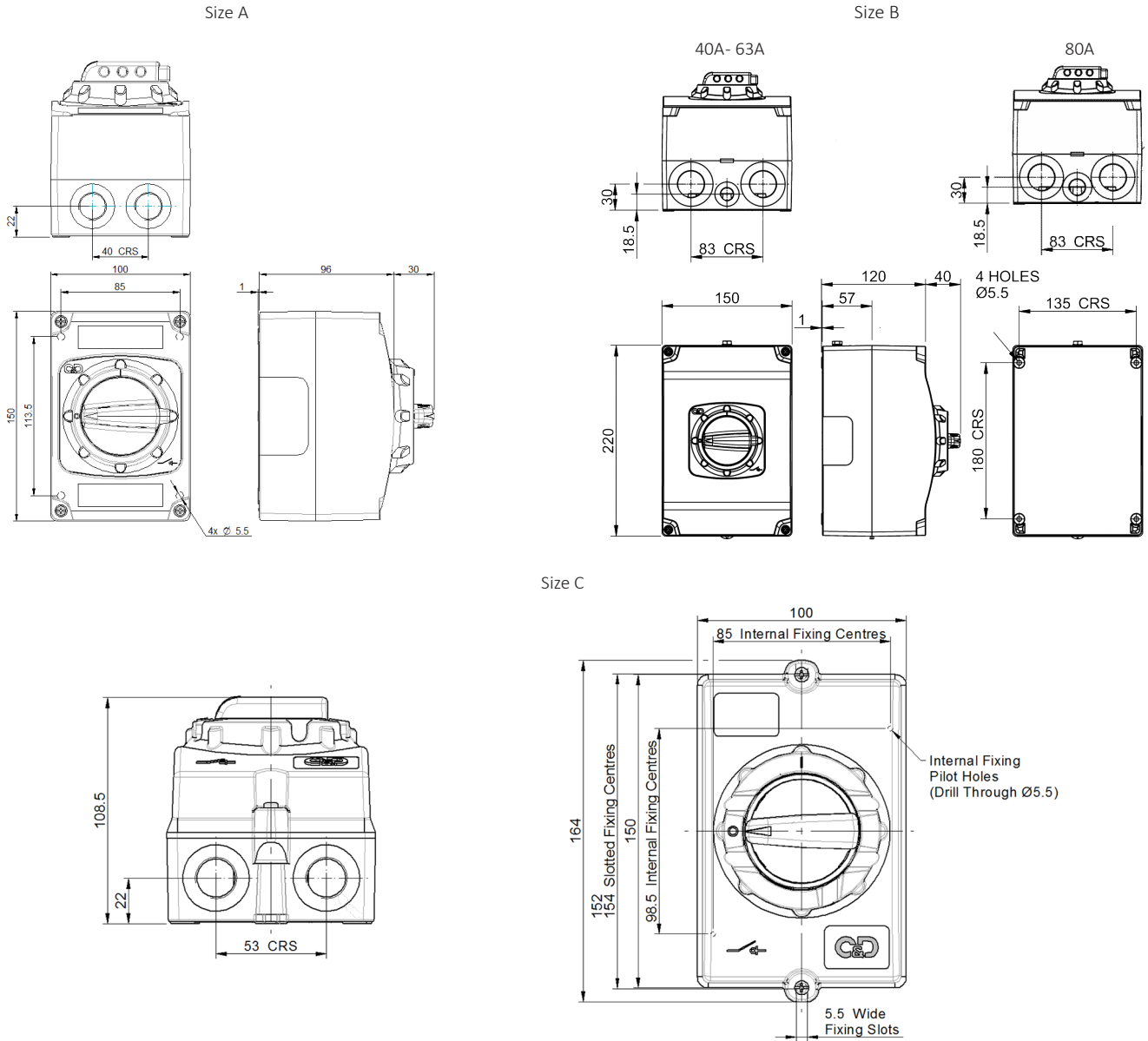

Rating	Cat. No.	Cable Entries					
		Enclosure A		Enclosure B		Enclosure C	
		Top	Bottom	Top	Bottom	Top	Bottom
20A- 32A	Standard	--	2 x M20	--	--	--	2x M25
	Suffix X	--	2x M25	--	--	--	2x M25
	Suffix Y	2x M25	2x M25	--	--	2x M25	2x M25
40A	Standard	--	2x M25	--	2x M25 + 1x M20	--	2x M20
	Suffix X	--	2x M25	--	2x M32 + 1x M16	--	2x M25
	Suffix Y	2x M25	2x M25	2 x M32	2x M32 + 1x M16	2x M25	2x M25
63A	Standard	--	--	--	2x M25 + 1x M20	--	--
	Suffix X	--	--	--	2x M32 + 1x M16	--	--
	Suffix Y	--	--	2 x M32	2x M32 + 1x M16	--	--
80A	Standard	--	--	--	2x M32 + 1x M20	--	--
	Suffix X	--	--	--	2x M32 + 1x M16	--	--
	Suffix Y	--	--	2 x M32	2x M32 + 1x M16	--	--



SCATTERGOOD & JOHNSON LTD

ELECTRICAL ENGINEERING & FLUID CONTROL DISTRIBUTORS

Est.1899

At Scattergood & Johnson Ltd, we pride ourselves on being a technical distributor to specialist industries.

Working with a range of quality product manufacturers across a number of specialist markets, we are not your average 'box shifter' - we are your technical and supply chain partner.

We fully support every product we sell - for free! Our internal team and external sales engineers can answer any product or application question, no matter the complexity.

Backing up this technical ability is a range of 50,000+ products available from stock for nationwide next day delivery (same day if required!), or you can collect what you need from any of our trade counters around the UK.

Select your specialist interest below to learn more about how we can help.



Online, In Branch and On the Road - Scattergood & Johnson Ltd, there when you need us.

www.scatts.co.uk