

# INSTALLATION MANUAL

# B-ALARM

Basic Alarm Unit with 1 DI, 1 DO and SMS commands support



**SENECA**

SENECA s.r.l.

Headquarters: Via Austria, 26 – 35127 – PADOVA – ITALY

Phone +39.049.8705355 - 8705359 - Fax +39.049.8706287





Manuals and configuration software are available at : [www.seneca.it](http://www.seneca.it)

This document is the property of SENECA Srl. Duplication and reproduction are forbidden, if not authorized. The contents of the present document refer to products and technologies described in it. This informations may be modified or integrated for technical and / or commercial requirements.

## TECHNICAL SPECIFICATIONS

<b>DIGITAL INPUT</b> <i>Max. Frequency</i> <i>Threshold OFF / Threshold ON</i>	Reed, contact, NPN 2 wires and FD01 5 Hz 0 – 2 V <sub>DC</sub> , I < 1mA / 12 – 24 V <sub>DC</sub> , I > 3mA
<b>DIGITAL OUTPUT</b>	Relay 2 A max - 250V SPDT
<b>AUXILIARY VOLTAGE OUTPUT</b>	10 – 28 V <sub>DC</sub>
<b>USB PORT</b>	One micro USB socket for upgrade and device configuration
<b>SIM card Slot</b>	Push-Push for mini SIM (15 x 25 mm)
<b>GSM</b>	Quad band (850 / 900 / 1800 / 1900 MHz)
<b>POWER SUPPLY</b> <i>Voltage</i> <i>Consumption</i> <i>Internal battery</i>	10 – 28 V <sub>DC</sub> 3.5 W Max. Nickel metal hydride ( NiMh ) rechargeable battery, 600 mAh,
<b>ENVIRONMENTAL CONDITIONS</b> <i>Temperature</i> <i>Humidity</i> <i>Storage Temperature</i>  <i>Protection degree</i>	Recommended range with external power supply: -20° – +55°C. Recommended range with backup battery power: 0° – +50°C. 30% – 90% non condensing. from -20 °C to +35 °C from -20 °C to +60 °C < 1 month IP20
<b>STANDARDS</b>	<b>ETSI EN 301 489-7</b> <b>EN301 511</b> <b>EN301 489-1</b> <b>IEC / EN 60950</b>
<b>CONNECTIONS</b>	Screw terminal board, 3.5 mm pitch, Micro USB connector and SMA connector for GSM antenna.

## PRELIMINARY WARNINGS

	Disposal of electrical & electronic equipment (applicable throughout the EU and other countries with separate collection programs). The symbol found on this product or on its packaging, indicates that this product must be handed over to an authorised collection point for <b>the recycling of electrical and electronic equipment.</b>
	<b>Before performing any operation it is mandatory to read the full contents of this manual.</b> The module may only be used by qualified and skilled technicians in the field of electric installation.
	Only the Manufacturer is authorized to repair the module or to replace damaged parts. The product is susceptible to electrostatic discharge, take appropriate countermeasures during any operation.
	The warranty is null and void in case of improper use or tampering of the module or devices supplied by the Manufacturer, necessary for its correct operation and if the instructions in this manual have not been complied with.

## INSTALLATION RULES

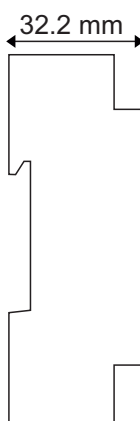
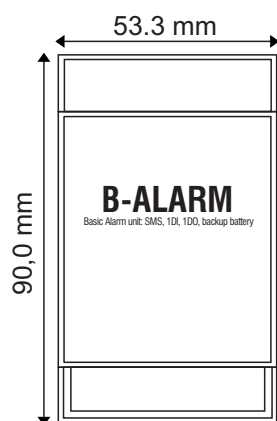

### IEC EN 60175 DIN RAIL FIXING

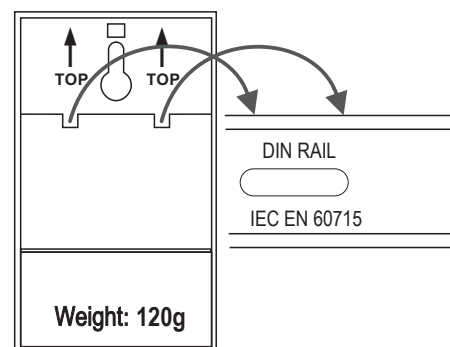

The device can be installed on a wall or on a IEC EN 60715 DIN rail. Never place this device inside shielded framework and near heat sources.

## PROCEDURE TO TURN THE DEVICE ON AND OFF

The device turns on when you connect the device terminals (Power supply + and -).

To switch off the module, remove power supply from + and- terminals socket and hold the OFF button, near the GSM antenna socket, for at least 6 seconds.

## THE FIRST CONFIGURATION

Before inserting the SIM-CARD into the B-Alarm slot, using a smart-phone, you must:

- **activate the SIM or ensure the SIM has already been activated**
- **make sure that there are no SMS messages stored in the SIM**
- **make sure that the SIM remaining credit is sufficient**
- **disable the PIN.**

Switching the device on for the first time, please follow these operations in the order stated:

- 1 **Make sure that B-Alarm is switched OFF and without power supply.**
  - 2 Connect the antenna.
  - 3 **Insert the SIM card.**  
The figure shows the correct orientation of the SIM card.
  - 4 Connect the device terminals (Power supply + and -) **to a power supply** and provide power.
  - 5 The green LED blinks slowly and the yellow Led blinks quickly because the device tries to connect to the GSM network.
  - 6 When the Yellow LED blink slowly the device is connected to the GSM network.
- 7 With the mobile phone you want to use as remote control, **call the number of the B-Alarm SIM (the calling duration must be at least one phone ringing tone and anonymous phone numbers are not allowed).**
  - 8 If the COMMANDS phonebook is empty, then the mobile phone number is saved in both B-Alarm phonebooks: the COMMANDS and the ALARMS phonebooks.
  - 9 When the green LED comes on with a fixed light, then B-Alarm is ready to use.

**The metal contacts of the SIM card are on the underside**

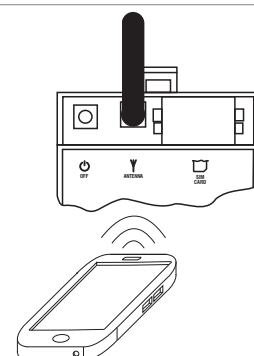
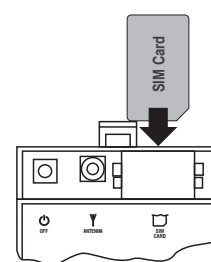

## ELECTRICAL CONNECTIONS

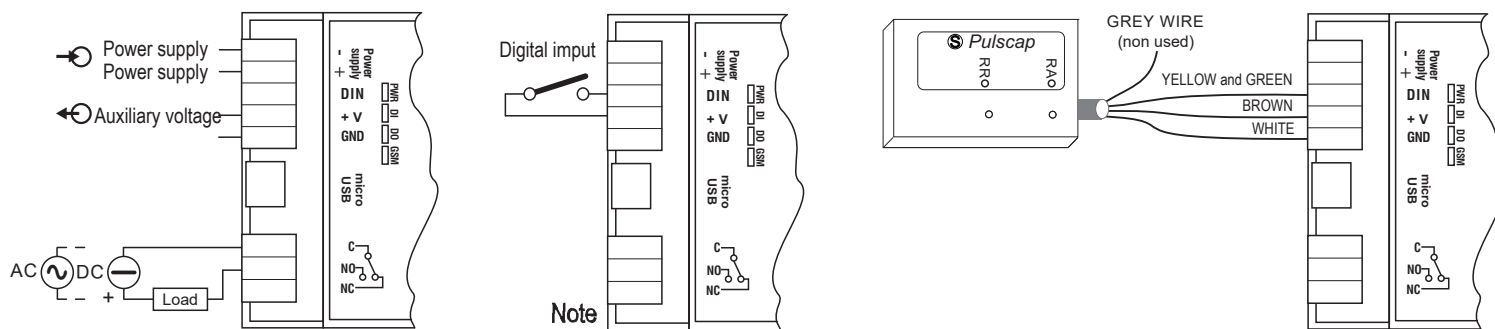

**Note:** The absence of power supply also causes the lack of auxiliary voltage and then in addition to the blackout alarm, the opening of the contact at the input will also be signalled.

## BACKUP BATTERY

The device is supplied with a backup battery that allows operation without main power supply.

**If you power ON the device for the first time, you must supply power through the + and - terminals, for at least 4 hours, in order to charge the internal battery.**

### • USB PORT AND POWER SUPPLY

The device has a micro USB socket, on the lower part of the module, which can be used to configure the device and to upgrade the firmware. You can't supply power to the device through the USB socket.

**The internal battery can be recharged only from - and + terminals**

You can order a dedicated power supply for this device, as an accessory, with code: ALIM-MY2.

## LED SIGNALLING ON FRONT PANEL

LED	Status	LED's meaning
GSM (Yellow)	Slow Blinking 0.2s ON □ 0.3s OFF ■	□■■■■■■■■□■■■■■■■■ B-Alarm is Connected to GSM Network.
	Fast Blinking 0.2s ON □ 0.2s OFF ■	□■□■□■□■□■□■□■□■ Searching for GSM network or signal missing
PWR (Green)	ON □	The list of COMMANDS isn't empty and the B-Alarm is connected to the GSM network correctly.
	Fast Blinking 0.2s ON □ 0.2s OFF ■	□■□■□■□■□■□■□■□■ Sending SMS error or ring from B-Alarm to mobile phone.
	Slow Blinking 0.8s ON □ 0.8s OFF ■	□□□□■■■■□□□□■■■■ The list of COMMANDS is empty.
	Two Blinks 0.2s ON □ 0.2s OFF ■	□■□■■■■■■■■■■■■■■■■ Error while entering the PIN code of the SIM card.
	Three Blinks 0.2s ON □ 0.2s OFF ■	□■□■□■■■■■■■■■■■■■■ The SIM card is not inserted correctly.
Four Blinks 0.2s ON □ 0.2s OFF ■	□■□■□■□■■■■■■■■■■■■ B-Alarm does not receive the GSM network signal	
Five Blinks 0.2s ON □ 0.2s OFF ■	□■□■□■□■□■■■■■■■■■■ B-Alarm is initialized but not connected to the GSM network.	

## LIST OF SMS EXECUTABLE COMMANDS

COMMAND	SINTAX	EXAMPLE
<b>ALCOUNTEN:</b> Enables the counter alarm when the threshold is exceeded	ALCOUNTEN = <chn>, <threshold>	ALCOUNTEN = 1, 123456789
<b>ALDIS:</b> Disables the input alarm and the blackout alarm	ALDIS = <argument>	ALDIS = 1 (Disables input alarm) ALDIS = POW (Disables blackout alarm)
<b>ALEN:</b> Enables the input alarm and the blackout alarm	ALEN = <chn>, <status>	ALEN = 1,open (Enables alarm on opening) ALEN = 1,close (Enables alarm on closing) ALEN = POW (Enables blackout alarm)
<b>NOTE:</b> in the example «ALEN = 1, open» is used to change the status when the alarm is triggered (open or closed) If the status is empty «ALEN = 1», the command enables the alarm with the last configured configured stored status.		
<b>ALTOT:</b> Shows the totalizer alarm configuration	ALTOT?	
<b>ALTOTDIS:</b> Disables the totalizer alarm	ALTOTDIS= <chn>	ALTOTDIS = 1
<b>ALTOTEN:</b> Enables the totalizer alarm and sets a threshold value	ALTOTEN= <chn>, <threshold>	ALTOTEN = 1, 123456789
<b>CFGOUT:</b> Shows the digital output configuration or sets the digital output as N.C. or N.O.	CFGOUT? CFGOUT = <chn>, <status>	CFGOUT? (Shows output configuration) CFGOUT = 1, NC (Sets output as N.C.) CFGOUT = 1, NO (Sets output as N.O.)
<b>CLK:</b> Shows the clock value or sets time and date (after + quarters of an GMT hour are shown)	CLK? CLK = <gg/mm/aaaa> <hh:mm:ss> <GMT>	CLK? (Shows the clock value) CLK = 1/2/12 8:40:53 +4 (Sets the clock at 1/2/12 8:40:53 GMT+1) CLK = 22/01/2018 12:00:00 -8 (Sets the clock at 22/1/18 12 o'clock GMT-2)
<b>CLOSE:</b> Closes the digital output	CLOSE = <chn>	CLOSE=1
<b>COUNT:</b> Shows the counter value	COUNT?	
<b>COUNTE:</b> Shows the counter value and resets the counter	COUNTE= <chn>	COUNTE = 1
<b>COUNTSET:</b> Umposes a value on the counter	COUNTSET= <chn>, <value>	COUNTSET = 1, 999999990 (Sets the counter to 999999990)
<b>CREDIT:</b> Shows the remaining credit	CREDIT?	
<b>CREDITPARAM:</b> Shows the actual message for the remaining credit request or sets the new message for the remaining credit request	CREDITPARAM? CREDITPARAM = <text message>	CREDITPARAM=PRE CRE SIN (Shows the actual message) CREDITPARAM = Balance (Sets the new Message: «Balance»)
<b>POSTPONED COMMAND:</b> Execution of Fast Commands at a given date / time. See Fast Commands list on page 7	0-15, <+> <DD/MM/YYYY> <hh:mm:ss>	8 (The Fast Command 8 is executed immediately) 8, 01/01/2012 12:00 (The Fast Command 8 it will be executed on 01/01/2012 at 12 o'clock)

## LIST OF SMS EXECUTABLE COMMANDS

<b>DELTA:</b> shows the status of the low production alarm configuration or sets the low production alarm	DELTA? DELTA = <value>, <enable>,<mode>	DELTA? DELTA1? DELTA=D (Disables the low production alarm) For the other commands, see the examples:
---	---	---

**DELTA1=345,E,MONTH** (Enables the low production alarm to the 345 value: If, starting from 0, e.g. on 7/3, the digital input counter doesn't exceed 345, within one month, an alarm is triggered automatically at the end of the month).

**DELTA1=333,E,DAY** (Enables the low production alarm to the 333 value: If, starting from 0, e.g. on 7/3, the digital input counter doesn't exceed 333, within one day, an alarm is triggered automatically at the end of the 24 hours).

**DELTA1=9,E,HOUR** (Enables the low production alarm to the 9 value: If, starting from 0, e.g. at 17:00, the digital input counter doesn't exceed 9, within one hour, an alarm is triggered automatically at the end of the 60 minutes).

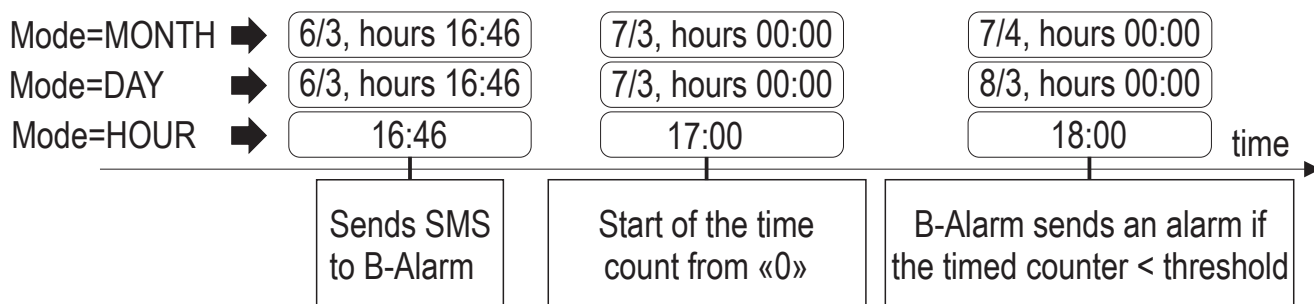

COMMAND	SINTAX	EXAMPLE
<b>FACTORY:</b> Loads all the default values deleting the current configuration	FACTORY = <pass>	FACTORY = 3387
<b>FWCODE:</b> Shows the firmware version	FWCODE?	
<b>HYSTIME:</b> Inhibition time of input alarm before generating of the next.	HYSTIME = <argument>, <min.>	HYSTIME=1, 300 HYSTIME=POW, 3
<b>IDOPERATOR:</b> Shows or sets the mobile phone operator configuration	IDOPERATOR? IDOPERATOR=<id>	IDOPERATOR=0 IDOPERATOR=1 IDOPERATOR=2
<b>IN:</b> Shows the digital input value	IN#?	IN1?
<b>NUMCREDIT:</b> Shows or sets the number for the residual credit request	NUMCREDIT? NUMCREDIT = + <phone_number>	NUMCREDIT=+404 NUMCREDIT=+40916 NUMCREDIT=+4155
<b>NUMIN:</b> Shows or adds a phone number into the commands list	NUMIN? NUMIN=<phone_number>	NUMIN? NUMIN=+39 3281234567
<b>NUMINE:</b> Erases a phone number from the commands list	NUMINE=<phone_number>	NUMINE=+39 3411234567
<b>NUMOUT:</b> Shows or adds a phone number to the alarm list	NUMOUT? NUMOUT=<phone_number>	NUMOUT? NUMOUT=+39 3331234567
<b>NUMOUTE:</b> Erases a phone number from the alarm list	NUMOUTE=<phone_number>	NUMOUTE=+39 3301234567

## LIST OF SMS EXECUTABLE COMMANDS

COMMAND	SINTAX	EXAMPLE
<b>NUMSIM:</b> Adds a phone number to the SIM extended phone-book to perform a command on the ring tone.	NUMSIM=<phone_number>	NUMSIM=+39 3301234567
<b>NUMSIME:</b> Erases a phone number from the SIM extended phone-book to stop a command execution on the ring tone.	NUMSIME=<phone_number>	NUMSIME=+39 3331234567 NUMSIME=ALL (Erases all numbers)
<b>OPEN:</b> Opens the digital output	OPEN=<chn>	OPEN = 1
<b>PASS:</b> Shows the password	PASS?	
<b>RINGCMD:</b> shows or configures the command to be performed on the ring tone see command list on p. 7	RINGCMD? RINGCMD=<command>	RINGCMD=NULL RINGCMD=STATUS? RINGCMD=COUNT? RINGCMD=CLOSE=1
<b>SIMCONFIG:</b> Shows or sets the SIM card configuration	SIMCONFIG? SIMCONFIG=<command>	SIMCONFIG=DATA or VOICE SIMCONFIG=SMSCREDIT SIMCONFIG=RINGCREDIT SIMCONFIG=SWSMSDISABLE SIMCONFIG=SWSMSENABLE SIMCONFIG=PINENABLE,0000
<b>SMSCENTER:</b> Shows or sets the number of SMS service center	SMSCENTER? SMSCENTER=+00000000	
<b>STATUS:</b> Shows the B-Alarm status	STATUS?	
<b>TCLOSE:</b> Closes the digital output for a pre-set time	TCLOSE = <chn>, <seconds>	TCLOSE=1,20 TCLOSE=1,300
<b>TIMER:</b> Shows or sets the configuration of one of the four timers	TIMER? TIMER<number>? TIMER=<enable/disable> TIMER<number>=<enable/disable>	TIMER? TIMER1? TIMER4? TIMER=ENABLE TIMER=DISABLE TIMER4=ENABLE TIMER1=DISABLE
<b>TOGGLE:</b> Changes the output status	TOGGLE=<chn>	TOGGLE=1
<b>TOPEN:</b> Opens the digital output for a pre-set time	TOPEN = <chn>, <seconds>	TOPEN=1,20 TOPEN=1,300
<b>TOT:</b> Shows the totalizer value	TOT?	
<b>TOTE:</b> Shows and resets the totalizer value	TOTE#?	TOTE1?
<b>TOTSET:</b> Sets the totalizer value	TOTSET=<chn>, <value>	TOTSET=1, 99999990

## LIST OF SMS EXECUTABLE COMMANDS

COMMAND	SINTAX	EXAMPLE
<b>ADDCLK:</b> Adds or subtracts an offset in seconds to the internal clock	ADDCLK = <offset_seconds>	ADDCLK = +3600 ADDCLK= - 1522
<b>AL:</b> Shows the configuration of input alarm	AL?	
<b>ALCOUNT:</b> Shows the configuration of counter alarm	ALCOUNT?	
<b>ALCOUNTDIS:</b> Disables the counter alarm	ALCOUNTDIS = <chn>	ALCOUNTDIS = 1

## LIST OF EXECUTABLE COMMANDS BY A RING, EVENT OR FAST COMMAND

The Easy Setup software allows you to program the B-Alarm. The reception by the device of a phone ring or a particular event or a fast command causes the execution of one of the following commands:

CLOSES THE OUTPUT	CHANGES THE OUTPUT STATUS	COUNTER RESET
CLOSES THE TIMED OUTPUT	REMAINING CREDIT REQUEST	DISABLES PHONE-RING COMMAND
OPENS THE OUTPUT	INPUT ALARM STATUS REQUEST	ENABLES PHONE-RING COMMAND
OPENS THE TIMED OUTPUT	COUNTER VALUE REQUEST	ENABLES TIMER 1, 2, 3, 4
ENABLES ALARM IF INPUT IS CLOSED	TOTALIZER VALUE REQUEST	DISABLES TIMER 1, 2
ENABLES ALARM IF INPUT IS OPEN	INPUT STATUS REQUEST	DISABLES POSTPONED COMMAND
DISABLES THE INPUT ALARM	B-Alarm STATUS REQUEST	ENABLES POSTPONED COMMAND

Using the Easy Setup software, all the previous commands can be combined with a fast command.

## SIM CARD REMAINING CREDIT

The SMS you must send to obtain the remaining credit from the mobile operator is determined by the SIM:

**Contract SIM cards:** You must contact your mobile operator.

**SIM from any mobile operators:** use the Easy Setup configuration software

(downloadable for free from: [www.seneca.it](http://www.seneca.it) in the easy software products section)

## ORDER CODES

Code	Description
<b>ALIM-MY2</b>	Power supply 12V $\overline{\text{=}}$ 1000 mA
<b>FD01</b>	Photodiode-detector for pulse counting 10 Hz max (PULSCAP input).
<b>A-GSM</b>	GSM butterfly adhesive antenna, 3.0 m cable
<b>BATT-GP80</b>	Replacement battery

## CONTACTS

Technical support	<a href="mailto:support@seneca.it">support@seneca.it</a>
Product Informations	<a href="mailto:sales@seneca.it">sales@seneca.it</a>



**SCATTERGOOD  
& JOHNSON LTD**  
ELECTRICAL ENGINEERING & FLUID CONTROL DISTRIBUTORS

Est.1899

At Scattergood & Johnson Ltd, we pride ourselves on being a technical distributor to specialist industries.

Working with a range of quality product manufacturers across a number of specialist markets, we are not your average 'box shifter' - we are your technical and supply chain partner.

We fully support every product we sell - for free! Our internal team and external sales engineers can answer any product or application question, no matter the complexity.

Backing up this technical ability is a range of 50,000+ products available from stock for nationwide next day delivery (same day if required!), or you can collect what you need from any of our trade counters around the UK.

Select your specialist interest below to learn more about how we can help.



Online, In Branch and On the Road - Scattergood & Johnson Ltd, there when you need us.

**[www.scatts.co.uk](http://www.scatts.co.uk)**