



LED Indicators

Spherical

Series SFT and SLT



Series SFT and SLT

Technical features

Body material: **Polycarbonate (PC) V0/UL 94**
 Body colour: **Black**
 Protection degree: **IP54**
 Working temperature: **-20°C +60°C**
 Operating life at AT 25°C: **> 100.000 h**
Not replaceable LEDs



Available with integrated Lamp Test circuit (LT), to test all signals at once.



Available with Inbuilt Diode (PD) to avoid reverse feeding and Tropicalization treatment.



Optional Blinking Light Max 130V.

Customs tariff: **85389091**

Supply voltage +/- 10%

Power	Consumption	Current
12 Vac/dc	15-20mA	AC/DC
24 Vac/dc	15-20mA	AC/DC
48 Vac/dc	15-20mA	AC/DC
130 = 110-130 Vac/dc	15-20mA	AC/DC
240 Vac	15mA	Alternating Current
220 Vdc	9mA	Direct Current

Other power supplies on request



Integrated Rectifier Bridge to work in Alternating Current (AC) or Direct Current (DC), automatically.



Easy to connect thanks to the Faston terminals 2.8mm x 0.8mm, Screw terminals or Flying Leads.

Compliance:

Directive 2006/95/EC Low Voltage

Directive 2004/108/EC Electromagnetic Compatibility

Directive 2011/65/EC RoHS

Directive 2006/42/EC Machinery

Conformity to standards:

EN 60947.5.1 / EN 60073 / EN 60529 / EN 60068-2-6 /

EN 60204.1 / EN ISO 7731 / EN 981 / IEC 536

DOMO reserves the right to change, amend, modify, suspend, continue or terminate all or any part of the Product range either in an individual case or in general, at any time without notice.

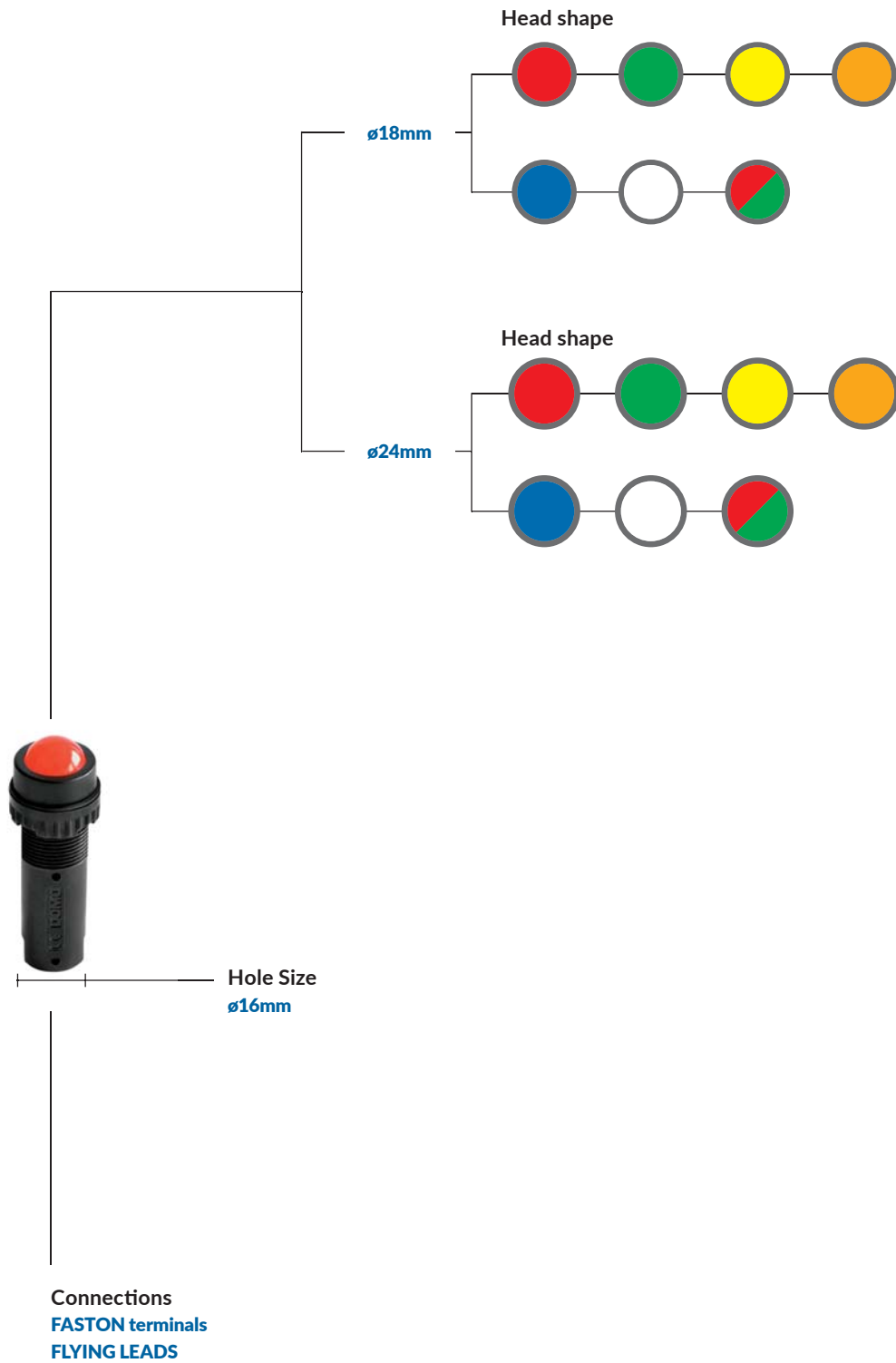

Series SFT - ø16mm

Coding

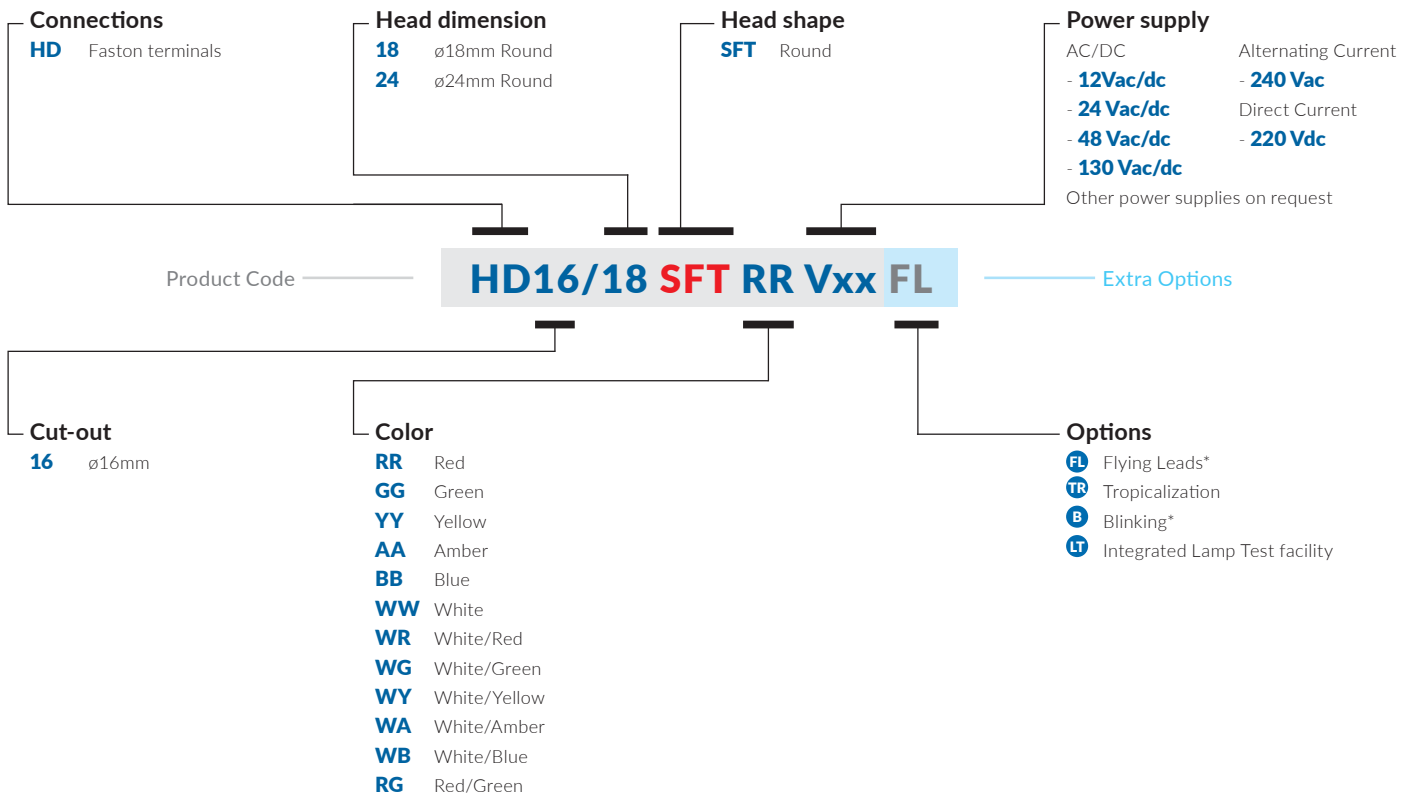

Please see product range section for the feasibility. Special version on request.

* Please contact our sales office to define details.



Series SFT - Ø16mm

Product range

16/18
 Head Ø18mm
 Cut-out Ø16
 LED diffuser: Ø13,50mm
 Weight 8g



16/24
 Head Ø18mm
 Cut-out Ø16
 LED diffuser: Ø19mm
 Weight 10g



Colors

LED diffuser	LED
--------------	-----

Standard type

● Red	● Red	HD16/18 SFT RR Vxx	HD16/24 SFT RR Vxx
● Green	● Green	HD16/18 SFT GG Vxx	HD16/24 SFT GG Vxx
● Yellow	● Yellow	HD16/18 SFT YY Vxx	HD16/24 SFT YY Vxx
● Amber	● Amber	HD16/18 SFT AA Vxx	HD16/24 SFT AA Vxx
● Blue	● Blue	HD16/18 SFT BB Vxx	HD16/24 SFT BB Vxx
○ White	○ White	HD16/18 SFT WW Vxx	HD16/24 SFT WW Vxx
		FL TR LT	FL TR LT
○ White	● Red	HD16/18 SFT WR Vxx	HD16/24 SFT WR Vxx
○ White	● Green	HD16/18 SFT WG Vxx	HD16/24 SFT WG Vxx
○ White	● Yellow	HD16/18 SFT WY Vxx	HD16/24 SFT WY Vxx
○ White	● Amber	HD16/18 SFT WA Vxx	HD16/24 SFT WA Vxx
○ White	● Blue	HD16/18 SFT WB Vxx	HD16/24 SFT WB Vxx
		FL TR LT	FL TR LT

Bicolor LED

○ White	● Red/Green	HD16/18 SFT RG Vxx	HD16/24 SFT RG Vxx
		FL TR	FL TR

Series SFT - $\varnothing 16\text{mm}$

Dimensions and wiring

HD16/18 SFT

Dimensions mm 1:2

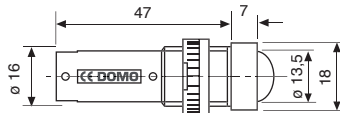

board thickness 10 mm
clamping: threaded nut

HD16/24 SFT

Dimensions mm 1:2

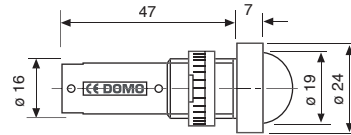

board thickness 10 mm
clamping: threaded nut

Faston terminals Tabs 2,8 x 0,8mm

Monocolor

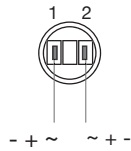

Bicolor

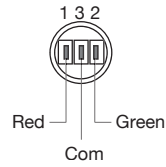

Monocolor + Lamp Test (LT)

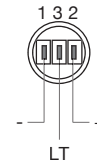

Flying Leads

Monocolor



1 - White
2 - Brown

Bicolor

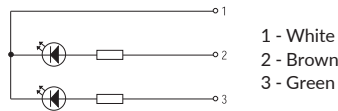

1 - White
2 - Brown
3 - Green

Monocolor + Lamp Test (LT)

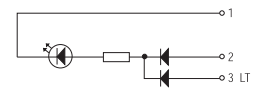

1 - White
2 - Brown
3 - Green

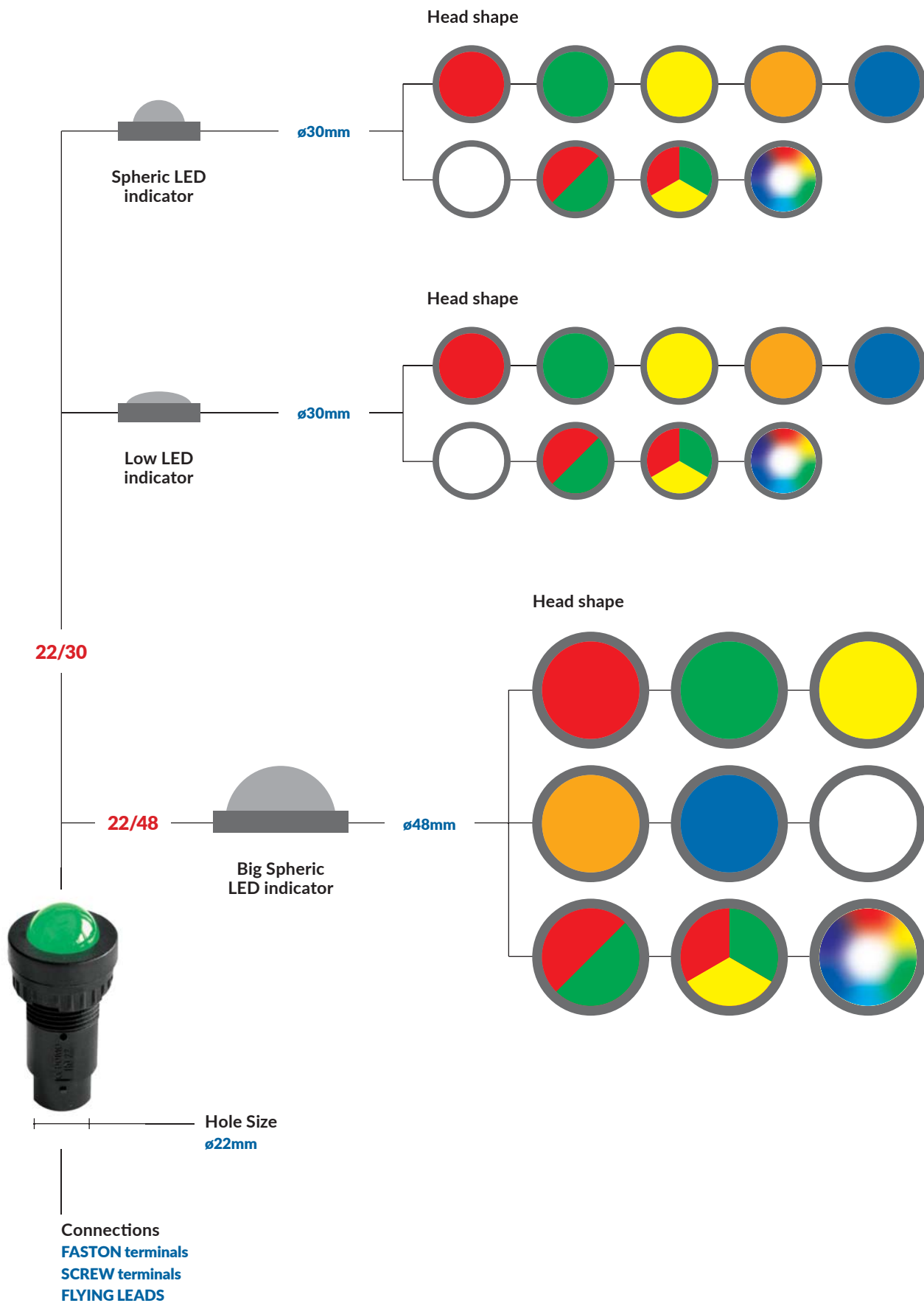

Series SFT and SLT - ø22mm

Coding

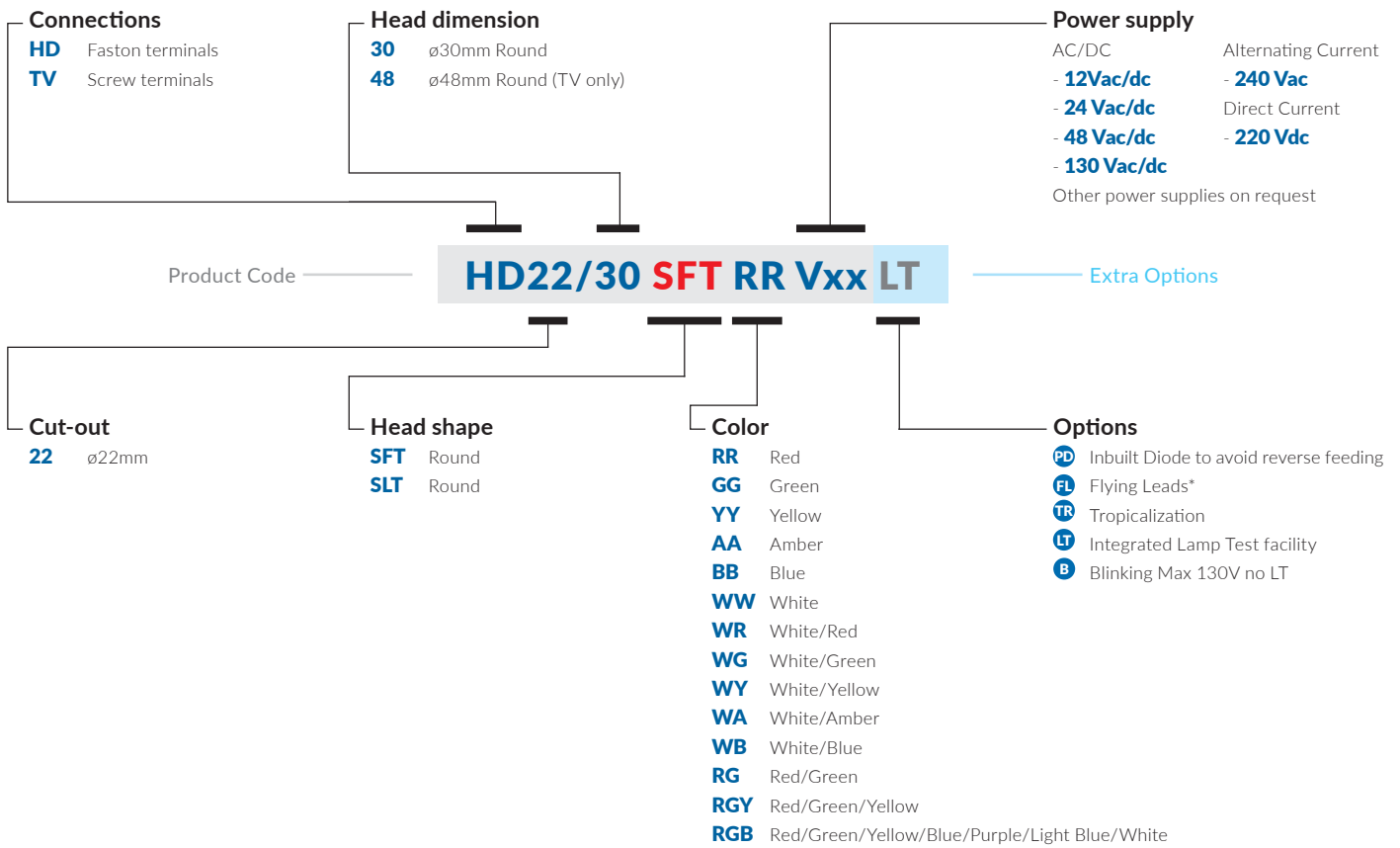

Please see product range section for the feasibility. Special version on request.

* Please contact our sales office to define details.



Series SFT and SLT - ø22mm

Product range

SFT
 Head Ø30mm
 Cut-out Ø22
 LED diffuser: Ø20mm
 Weight 15g



SLT
 Head Ø30mm
 Cut-out Ø22
 LED diffuser: Ø24mm
 Weight 16g



Colors

LED diffuser	LED
--------------	-----

Standard type

● Red	● Red	HD22/30 SFT RR Vxx	HD22/30 SLT RR Vxx
● Green	● Green	HD22/30 SFT GG Vxx	HD22/30 SLT GG Vxx
● Yellow	● Yellow	HD22/30 SFT YY Vxx	HD22/30 SLT YY Vxx
● Amber	● Amber	HD22/30 SFT AA Vxx	HD22/30 SLT AA Vxx
● Blue	● Blue	HD22/30 SFT BB Vxx	HD22/30 SLT BB Vxx
○ White	○ White	HD22/30 SFT WW Vxx	HD22/30 SLT WW Vxx
		PD TR LT	PD TR LT
○ White	● Red	HD22/30 SFT WR Vxx	HD22/30 SLT WR Vxx
○ White	● Green	HD22/30 SFT WG Vxx	HD22/30 SLT WG Vxx
○ White	● Yellow	HD22/30 SFT WY Vxx	HD22/30 SLT WY Vxx
○ White	● Amber	HD22/30 SFT WA Vxx	HD22/30 SLT WA Vxx
○ White	● Blue	HD22/30 SFT WB Vxx	HD22/30 SLT WB Vxx
		PD TR LT	PD TR LT

Bicolor, Multicolor

○ White	● Red/Green	HD22/30 SFT RG Vxx	HD22/30 SLT RG Vxx
○ White	● Red/Green/Yellow/ Blue/Purple/ Light Blue/White	HD22/30 SFT RGB Vxx	HD22/30 SLT RGB Vxx
		TR	TR

Series SFT and SLT - $\phi 22$ mm

Dimensions and wiring

HD22 SFT

Dimensions mm 1:2

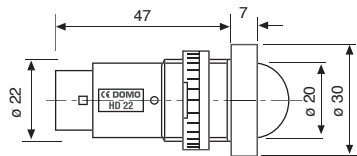

board thickness 10 mm
clamping: threaded nut

HD22 SLT

Dimensions mm 1:2

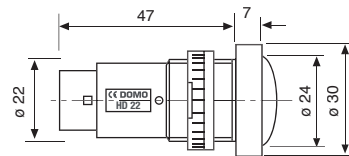

board thickness 10 mm
clamping: threaded nut

Faston terminals Tabs 2,8 x 0,8mm

Monocolor

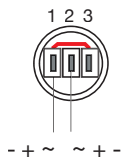

Monocolor + Lamp Test (LT)

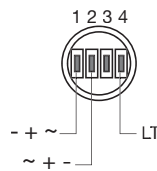

Bicolor

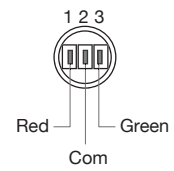

Multicolor

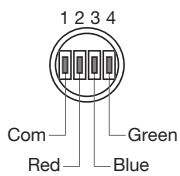

● Red	=	● Red
● Green	=	● Green
● Blue	=	● Blue
● Red + ● Green	=	● Yellow
● Red + ● Blue	=	● Purple
● Green + ● Blue	=	● L. Blue
● Red + ● Green + ● Blue	=	○ White



Series SFT and SLT - ø22mm

Product range

SFT
 Head Ø30mm
 Cut-out Ø22
 LED diffuser: Ø20mm
 Weight 18g



SLT
 Head Ø30mm
 Cut-out Ø22
 LED diffuser: Ø24mm
 Weight 19g



Colors

LED diffuser	LED
--------------	-----

Standard type

● Red	● Red	TV22/30 SFT RR Vxx	TV22/30 SLT RR Vxx
● Green	● Green	TV22/30 SFT GG Vxx	TV22/30 SLT GG Vxx
● Yellow	● Yellow	TV22/30 SFT YY Vxx	TV22/30 SLT YY Vxx
● Amber	● Amber	TV22/30 SFT AA Vxx	TV22/30 SLT AA Vxx
● Blue	● Blue	TV22/30 SFT BB Vxx	TV22/30 SLT BB Vxx
○ White	○ White	TV22/30 SFT WW Vxx	TV22/30 SLT WW Vxx
		PD FL TR LT B Max 130V no LT	PD FL TR LT B Max 130V no LT
○ White	● Red	TV22/30 SFT WR Vxx	TV22/30 SLT WR Vxx
○ White	● Green	TV22/30 SFT WG Vxx	TV22/30 SLT WG Vxx
○ White	● Yellow	TV22/30 SFT WY Vxx	TV22/30 SLT WY Vxx
○ White	● Amber	TV22/30 SFT WA Vxx	TV22/30 SLT WA Vxx
○ White	● Blue	TV22/30 SFT WB Vxx	TV22/30 SLT WB Vxx
		PD FL TR LT B Max 130V no LT	PD FL TR LT B Max 130V no LT

Bicolor, Tricolor and Multicolor

○ White	● Red/Green	TV22/30 SFT RG Vxx	TV22/30 SLT RG Vxx
○ White	● Red/Green/Yellow	TV22/30 SFT RGY Vxx	TV22/30 SLT RGY Vxx
○ White	● Red/Green/Yellow/ Blue/Purple/ Light Blue/White	TV22/30 SFT RGB Vxx	TV22/30 SLT RGB Vxx
		FL TR	FL TR

Series SFT and SLT - ø22mm

Dimensions and wiring

TV22/30 SFT

Dimensions mm 1:2

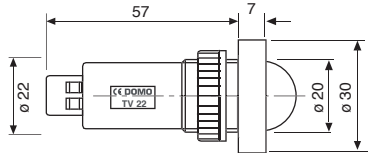

board thickness 10 mm
clamping: threaded nut

TV22/30 SLT

Dimensions mm 1:2

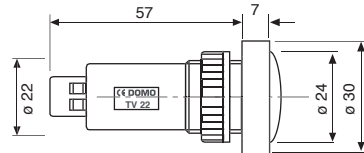

board thickness 10 mm
clamping: threaded nut

Screw terminal 14 AWG - 2,5mmq

Monocolor

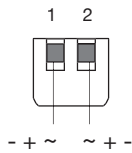

Monocolor + Lamp Test (LT)

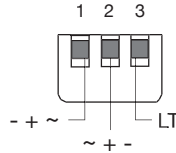

Bicolor

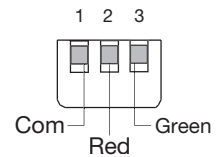

Screw terminal 16 AWG - 0,75 ÷ 1,0mmq

Tricolor

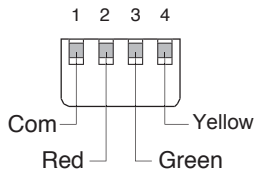

Multicolor

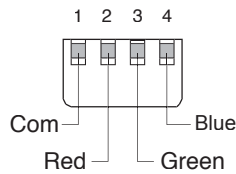

● Red	=	● Red
● Green	=	● Green
● Blue	=	● Blue
● Red + ● Green	=	● Yellow
● Red + ● Blue	=	● Purple
● Green + ● Blue	=	● L. Blue
● Red + ● Green + ● Blue	=	○ White

Flying Leads

Monocolor



Monocolor + Lamp Test (LT)

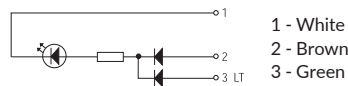

Bicolor

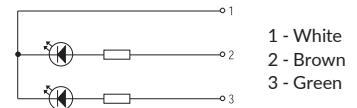

Tricolor

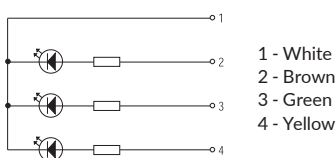

Multicolor

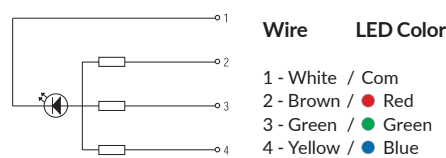

Brown	=	● Red
Green	=	● Green
Yellow	=	● Blue
Brown + Green	=	● Yellow
Brown + Yellow	=	● Purple
Yellow + Green	=	● L. Blue
Brown + Green + Yellow	=	○ White



Series SFT and SLT - ø22mm

Product range

SFT
 Head Ø48mm
 Cut-out Ø22
 LED diffuser: Ø39mm
 Weight 32g



Colors

LED diffuser	LED
--------------	-----

Standard type

● Red	● Red	TV22/48 SFT RR Vxx
● Green	● Green	TV22/48 SFT GG Vxx
● Yellow	● Yellow	TV22/48 SFT YY Vxx
● Amber	● Amber	TV22/48 SFT AA Vxx
● Blue	● Blue	TV22/48 SFT BB Vxx
○ White	○ White	TV22/48 SFT WW Vxx

PD FL TR LT B Max 130V no LT No 12V

○ White	● Red	TV22/48 SFT WR Vxx
○ White	● Green	TV22/48 SFT WG Vxx
○ White	● Yellow	TV22/48 SFT WY Vxx
○ White	● Amber	TV22/48 SFT WA Vxx
○ White	● Blue	TV22/48 SFT WB Vxx

PD FL TR LT B Max 130V no LT No 12V

Bicolor, Tricolor and Multicolor

○ White	● Red/Green	TV22/48 SFT RG Vxx
○ White	● Red/Green/Yellow	TV22/48 SFT RGY Vxx
○ White	● Red/Green/Yellow/ Blue/Purple/ Light Blue/White	TV22/48 SFT RGB Vxx

FL TR No 12V

Series SFT and SLT - $\varnothing 22\text{mm}$

Dimensions and wiring

TV22/30 SFT

Dimensions mm 1:2

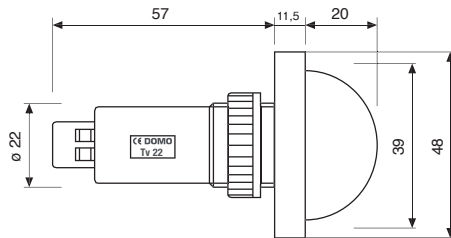

board thickness 10 mm
clamping: threaded nut

Screw terminal 14 AWG - 2,5mmq

Monocolor

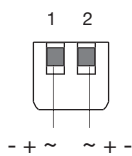

Monocolor + Lamp Test (LT)

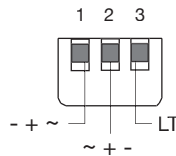

Bicolor

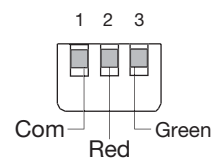

Screw terminal 16 AWG - 0,75 ÷ 1,0mmq

Tricolor

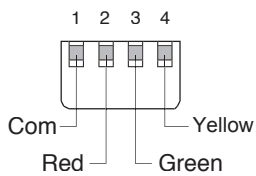

Multicolor

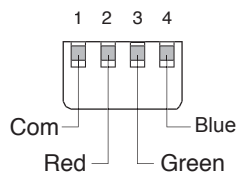

● Red	=	● Red
● Green	=	● Green
● Blue	=	● Blue
● Red + ● Green	=	● Yellow
● Red + ● Blue	=	● Purple
● Green + ● Blue	=	● L. Blue
● Red + ● Green + ● Blue	=	○ White

Flying Leads

Monocolor



Monocolor + Lamp Test (LT)

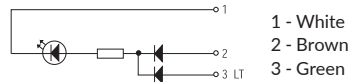

Bicolor

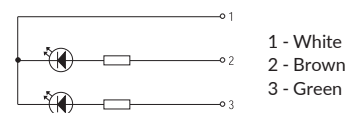

Tricolor

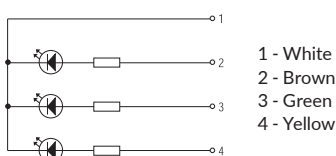

Multicolor

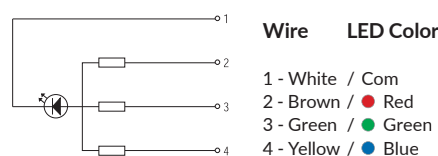

Brown	=	● Red
Green	=	● Green
Yellow	=	● Blue
Brown + Green	=	● Yellow
Brown + Yellow	=	● Purple
Yellow + Green	=	● L. Blue
Brown + Green + Yellow	=	○ White

Accessories and spare parts Ø16mm

Round label holder
Weight 1g



SIM16/24 PTR

Square label holder
Weight 1g



SIM16/24 PTS

Fastener for type B elements
Weight 2g



ASB18
ASB24

Reducer ring from Ø22mm to Ø16mm
Weight 2g



ARF 22/16

Labels
Weight 4g



SIM16/24 TOW

Protective slides
Weight 4g



SIM16/24 VPK

Tightening wrench
Weight 9g



ACK 22/16

Contact ring filler for Pushbutton Switches' central contact
Weight 1g



CD16 A3 EC

Accessories and spare parts Ø22mm

Round label holder
Weight 2g



SIM22/30 PTR

Square label holder
Weight 2g



SIM22/30 PTS

Fastener for type B elements
Weight 3g



ASB 30

**Reducer ring from ø30mm
to ø22mm**
Weight 2g



ARF 30/22

Labels
Weight 4g



SIM22/30 TOW

Protective slides
Weight 4g



SIM22/30 VPK

Tightening wrench
Weight 9g



ACK 22/16

Lamp extractor
Weight 2g

Compatible with:
BA9s, BA7s, T5.5, T5.5k, MG



AEL BA9s/T5.5

Attention! DOMO Srl reserves the right to change, amend, modify, suspend, continue or terminate all or any part of the Product range either in an individual case or in general, at any time without notice.

DOMO

Comparative table



Series	SFT	SLT	CR	PI	ML	VEB	PHR	
	Sferical	Sferical	Semaphore	Position	Multiled	Extrabright	Beacon	
Page	12	12	26	26	50	64	74	
Function								
Indicator	•	•	•	•	•	•	•	
Buzzer								
Pushbutton								
double pushbutton								
illuminated pushbutton								
Emergency mushroom								
Keylock switch								
selector switch								
Emergency for safety								
Design								
Protruding	•	•	•	•	•	•	•	
Flushmounting			•	•				
Round	•	•	•	•	•	•	•	
Square			•	•	•			
Rectangular								
Front protection (internal test)								
IP40					•			
IP54	•	•	•	•	•		•	
IP65					•	•		
IP67								
Contact rating								
10A								
5A								
Mounting Cut-out								
Ø8								
Ø12								
Ø16	•		•	•		•	•	
Ø22	•	•	•	•	•	•	•	
Terminal								
Faston 2,8x0,8	•	•	•	•	•	•	•	
Faston 2,8x0,5								
Screw	•	•	•	•	•	•	•	
Push-in (future)	F	F	F	F	F	F	F	
BA9s, Ba7s, E10, MG, BA15d, BA15s, E14								
Marking								
Paint, Engraving, Film insert				•	•			
Option								
Lamp Test (LT)	•	•	•	•	•			
Inbuilt Diode to avoid reverse feeding (PD)	•	•	•	•	•			
Tropicalization (TR)	•	•	•	•	•	•	•	
Double input + double lamp test (2C+2LT)			•					
Low voltage glow protection (LVGP)	F	F	F	F	F	F	F	
RGB color		•						
Compatible for DOMO Mosaic Mimic								
Protruding	•	•	•	•	•	•	•	
Flushmounting			•	•	•			

F = Future



**SCATTERGOOD
& JOHNSON LTD**
ELECTRICAL ENGINEERING & FLUID CONTROL DISTRIBUTORS

Est.1899

At Scattergood & Johnson Ltd, we pride ourselves on being a technical distributor to specialist industries.

Working with a range of quality product manufacturers across a number of specialist markets, we are not your average 'box shifter' - we are your technical and supply chain partner.

We fully support every product we sell - for free! Our internal team and external sales engineers can answer any product or application question, no matter the complexity.

Backing up this technical ability is a range of 50,000+ products available from stock for nationwide next day delivery (same day if required!), or you can collect what you need from any of our trade counters around the UK.

Select your specialist interest below to learn more about how we can help.

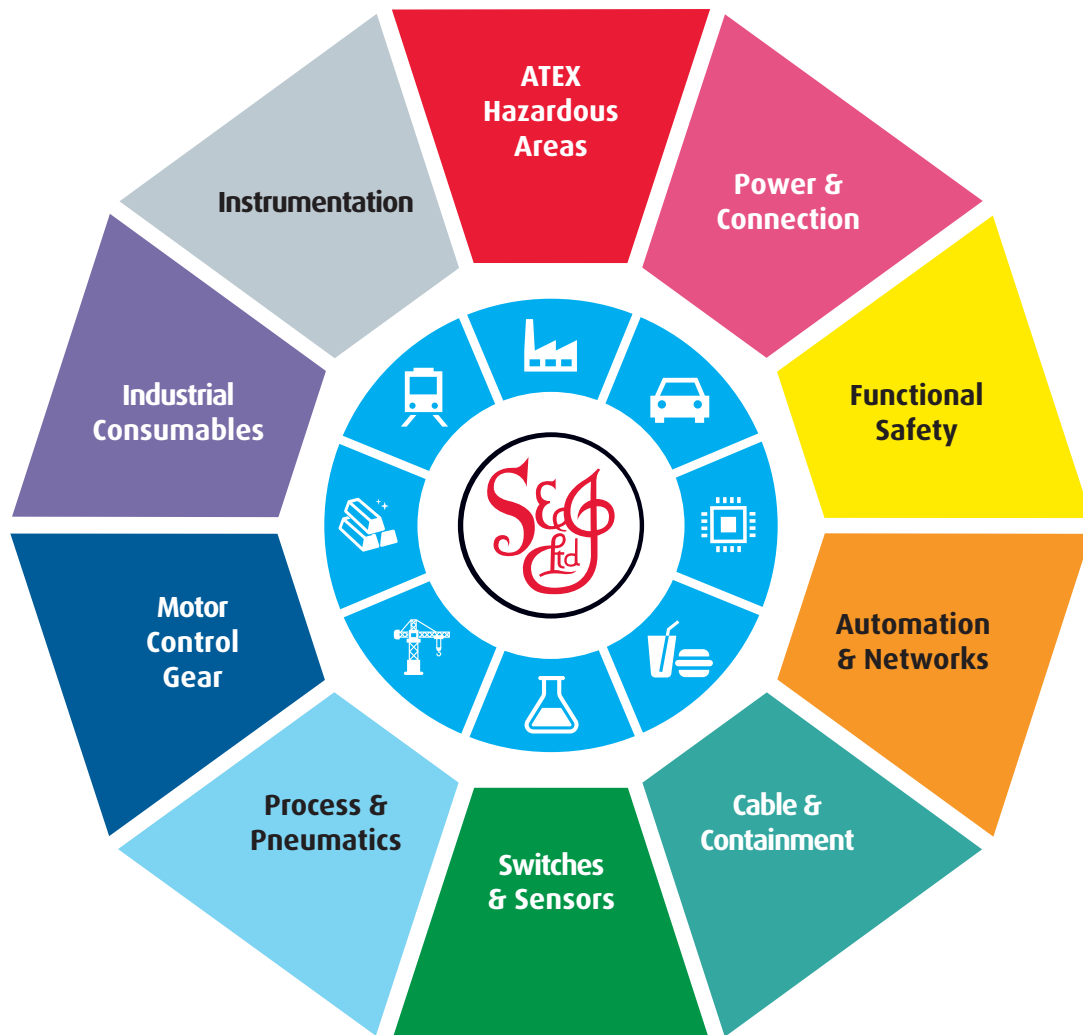

Online, In Branch and On the Road - Scattergood & Johnson Ltd, there when you need us.

www.scatts.co.uk