



GSE6L-P1211

G6

MINIATURE PHOTOELECTRIC SENSORS

SICK
Sensor Intelligence.



Ordering information

Type	Part no.
GSE6L-P1211	1105826

Other models and accessories → www.sick.com/G6

Illustration may differ



Detailed technical data

Features

Functional principle	Through-beam photoelectric sensor
Sensing range	
Sensing range min.	0 m
Sensing range max.	40 m
Recommended sensing range for the best performance	0 m ... 30 m
Polarisation filters	No
Emitted beam	
Light source	Laser
Type of light	Visible red light
Shape of light spot	Point-shaped
Light spot size (distance)	Ø 3.5 mm (1,000 mm)
Maximum dispersion of the emitted beam around the standardized transmission axis (squint angle)	< +/- 1.5° (at T _a = +23 °C)
Key laser figures	
Normative reference	IEC 60825-1 / CDRH 21 CFR 1040.10 & 1040.11
Laser class	1
Wave length	680 nm
Pulse duration	7 µs
Maximum pulse power	< 3.9 mW
Average service life	100,000 h at T _a = +25 °C
Smallest detectable object (MDO) typ.	3.5 mm, at 1 m distance (object with 90% remission (corresponds on standard white DIN 5033))
Adjustment	
Potentiometer	For setting the sensing range
Operating mode switch	For inverting the switching function (light/dark switching)
Indication	
LED green	Operating indicator Static: power on

LED yellow	Status of received light beam Static on: object present Static off: object not present
------------	--

Safety-related parameters

MTTF_D	1,005 years
DC_{avg}	0 %
T_M (mission time)	10 years (EN 60825-1)

Electrical data

Supply voltage U_B	10 V DC ... 30 V DC ¹⁾
Ripple	< 5 V _{pp}
Use category (according to EN 60947-5-2)	DC-13
Power consumption	≤ 20 mA, without load. At U _B = 24 V
Protection class	III
Digital output	
Number	2
Type	PNP
Signal voltage NPN HIGH/LOW	Approx. U _B / ≤ 3 V
Output current I _{max.}	≤ 100 mA ²⁾
Circuit protection outputs	Reverse polarity protected Overcurrent protected Short-circuit protected
Response time	≤ 625 μs
Switching frequency	1,000 Hz ³⁾
Pin/Wire assignment	
Function of pin 4/black (BK)	Digital output, light switching, object present → output Q HIGH
Function of pin 4/black (BK) – detail	The pin 4 function of the sensor can be switched, Additional possible settings via operating mode switch

¹⁾ Limit values U_B connections, reverse polarity protected.

²⁾ At U_B > 24 V, I max. = 50 mA.

³⁾ With light/dark ratio 1:1.

Mechanical data

Housing	Rectangular
Dimensions (W x H x D)	12 mm x 31.5 mm x 21 mm
Connection	Cable, 3-wire, 2 m
Connection detail	
Deep-freeze property	Do not bend below 0 °C
Conductor size	0.14 mm ²
Cable diameter	Ø 8 mm
Length of cable	2 m
Material	
Housing	Plastic, ABS
Front screen	Plastic, PMMA
Cable	PVC

Weight	Approx. 60 g
---------------	--------------

Ambient data

Enclosure rating	IP67 (EN 60529)
Ambient operating temperature	-20 °C ... +50 °C ^{1) 2)}
Ambient temperature, storage	-40 °C ... +70 °C
Typ. Ambient light immunity	Sunlight: ≤ 13,000 lx
Shock resistance	30 g, 11 ms (3 positive and 3 negative shocks along X, Y, Z axes, 18 total shocks (EN60068-2-27))
Vibration resistance	10 Hz ... 55 Hz (Amplitude 0.5 mm, 3x30 min (EN60068-2-6))
Air humidity	35 % ... 95 %, relative humidity (no condensation)
Electromagnetic compatibility (EMC)	EN 60947-5-2
UL File No.	NRKH.E348498 & NRKH7.E348498

¹⁾ As of $T_a = > 45 \text{ °C}$, a max. supply voltage $U_B = 24 \text{ V}$ and a max. load current $I_{max.} = 50 \text{ mA}$ is permitted.

²⁾ Below $T_a = -20 \text{ °C}$ a warm-up time of 3 seconds is required.

Classifications

ECl@ss 5.0	27270901
ECl@ss 5.1.4	27270901
ECl@ss 6.0	27270901
ECl@ss 6.2	27270901
ECl@ss 7.0	27270901
ECl@ss 8.0	27270901
ECl@ss 8.1	27270901
ECl@ss 9.0	27270901
ECl@ss 10.0	27270901
ECl@ss 11.0	27270901
ETIM 5.0	EC002716
ETIM 6.0	EC002716
ETIM 7.0	EC002716
ETIM 8.0	EC002716
UNSPSC 16.0901	39121528

Connection type

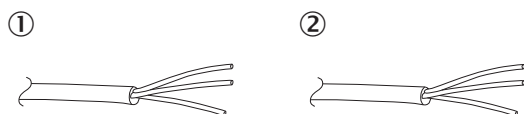

- ① Sender
- ② Receiver

Connection diagram

Cd-049

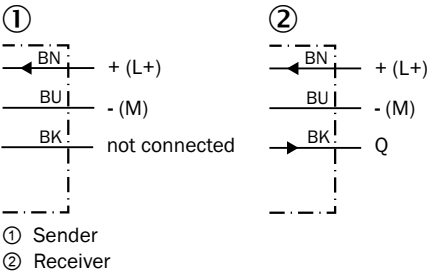

Truth table

PNP - light switching

	Light switching Q (normally closed)	
	Object not present → Output HIGH	Object present → Output LOW
Light receive	✓	✗
Light receive indicator	☀️	✗
Load resistance	⚠️	✗

PNP - dark switching

	Dark switching Q̄ (normally open)	
	Object not present → Output LOW	Object present → Output HIGH
Light receive	✓	✗
Light receive indicator	☀️	✗
Load resistance	✗	⚠️

Characteristic curve

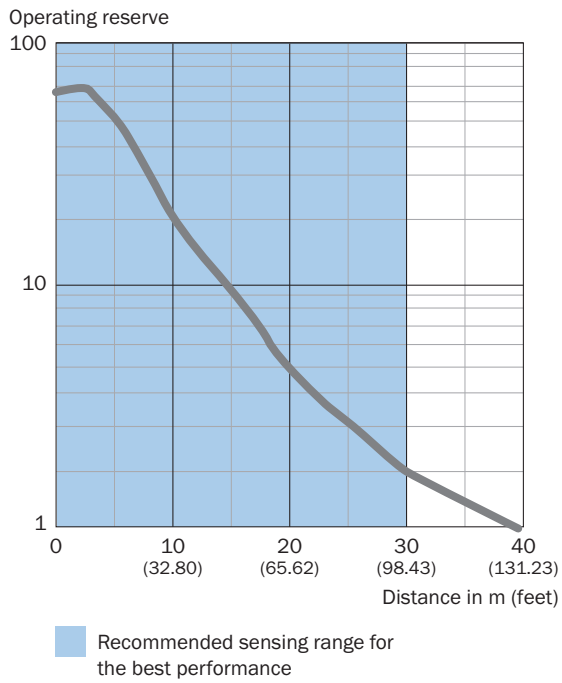

Light spot size

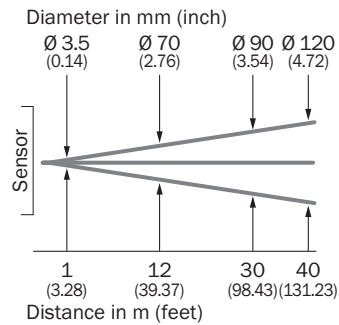

Sensing range diagram

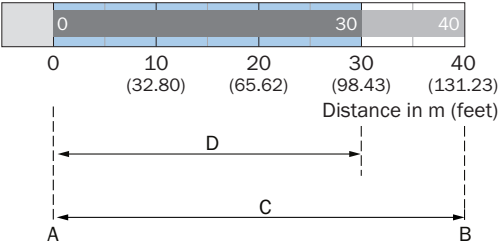

- A = Sensing range min. in m
- B = Sensing range max. in m
- C = Viewing range
- D = Adjustable switching threshold

 Recommended sensing range for the best performance

Adjustments

Display and adjustment elements

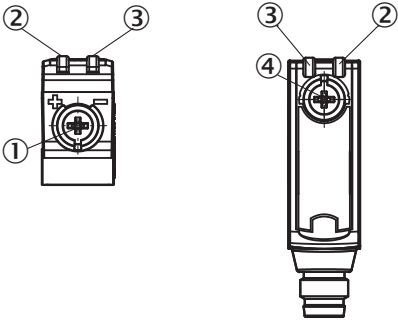

- ① Potentiometer
- ② LED yellow
- ③ LED green
- ④ Operating mode switch

Dimensional drawing (Dimensions in mm (inch))

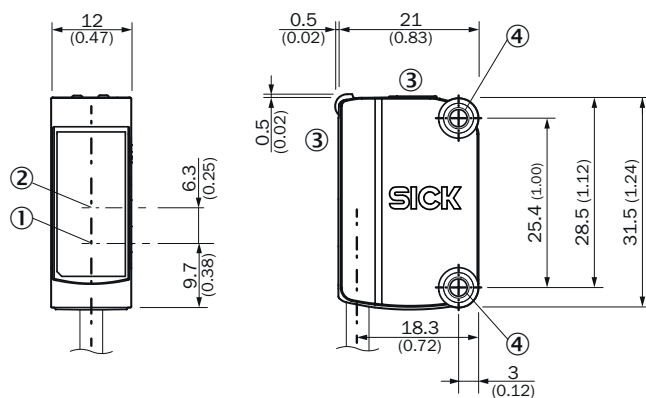

- ① Center of optical axis, sender
- ② Center of optical axis, receiver
- ③ Display and adjustment elements
- ④ Mounting holes M3

Recommended accessories

Mounting brackets and plates

Mounting brackets

Other models and accessories → www.sick.com/G6

Brief description	Type	Part no.
<ul style="list-style-type: none"> • Details: Stainless steel (1.4301) • Suitable for: G6 	BEF-WN-G6	2062909

SICK AT A GLANCE

SICK is one of the leading manufacturers of intelligent sensors and sensor solutions for industrial applications. A unique range of products and services creates the perfect basis for controlling processes securely and efficiently, protecting individuals from accidents and preventing damage to the environment.

We have extensive experience in a wide range of industries and understand their processes and requirements. With intelligent sensors, we can deliver exactly what our customers need. In application centers in Europe, Asia and North America, system solutions are tested and optimized in accordance with customer specifications. All this makes us a reliable supplier and development partner.

Comprehensive services complete our offering: SICK LifeTime Services provide support throughout the machine life cycle and ensure safety and productivity.

For us, that is “Sensor Intelligence.”

WORLDWIDE PRESENCE:

Contacts and other locations –www.sick.com