

Control Switches

CG, CH and CHR type up to 25 A



Kraus & Naimer

The development of the Blue Line rotary switch and motor starter product ranges is based on more than hundred years experience by Kraus & Naimer in the design and manufacture of electrical switchgear. Kraus & Naimer pioneered the introduction of the cam operated rotary switch and continues to be recognized as the world leader in that product field.

BLUE LINE

Blue Line products are protected by numerous patents through-out the industrial world. They are built to national and international standards and designed to withstand adverse temperatures and climates.

Blue Line products are accepted and universally recognized for their quality and workmanship. They are supported by a worldwide sales and service organization.

The Kraus & Naimer Registered Trademark



WORLDWIDE SYMBOL
FOR QUALITY SWITCHGEAR

Disconnectors and Main Switches acc. to IEC 60947-3 see Catalog 500

Contents	Page
Construction Data	4
Dimensions and Nominal Ratings	5
How to order	6, 7
Switch Function and Configuration	
ON/OFF Switches	9
Double-throw Switches	10-12
General Application Switches	12
Coding Switches	13
Multi-step Switches	14-16
Voltmeter Switches	17-19
Ammeter Switches	19-21
Volt-ammeter Switches	21
Control Switches	21, 22
Motor Switches	23-25
Types of Mounting	
Panel Mounting	26-29
Base Mounting	30, 31
Face Plates	32, 33
Handles	34
International Standards and Approvals	35
Technical Data	36-38
Tightening torque of screws	39
Dimensions	
Panel Mounting	40-43
Base Mounting	44, 45
Overall Switch Lengths	45, 46
Blue Line Switchgear: Summary	48

Construction Data

Cam switches of the CG, CH and CHR-series are designed for universal application and may ideally be used for control switches, instrumentation switches and motor control switches. Different contact designs, contact materials and terminals allow the use as well as in electronic circuitry and in aggressive environments in accordance with IEC 60947-3, EN 60947-3, VDE 0660 part 107, UL and cUL (cUR).

The stage is the basis for all switches and can be supplied with a maximum of 2 contacts. All switches of this series are supplied with open terminals which are accessible while the switch is installed. The terminals are protected against accidental finger contact according to EN 50274, VDE 0660 part 514 and DGUV V3. Captive plus-minus terminal screws and integrated screwdriver guides facilitate wiring. Due to the particular arrangement of the terminals of the CG switches, it is

possible to install the switches closely, side by side, or to mount them directly at the cable trays. The contact terminal numbers are easy to read, even if the switch is installed.

The captive plus-minus screws of the CH and CHR-series are located about 90° apart from the terminal direction. This allows for connecting wires without any interference with the terminal screws.

For connection with ring type terminals the CHR-series were designed. The switches are supplied with large open terminals. This allows for connection without removing the screws.

3 different Contact Systems are available

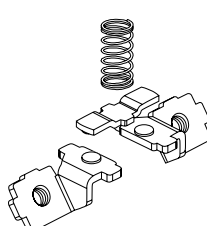
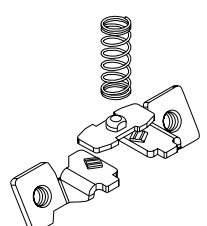
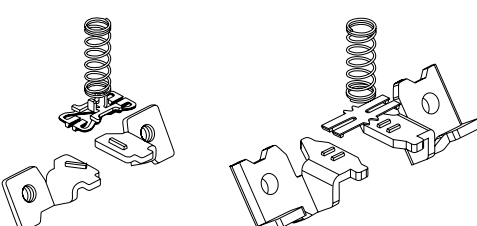
<p>CG6 to CHR16B</p>  <p>A rigid, double-break bridge with silver alloy contacts provides high making and breaking capabilities for regular control applications.</p>	<p>CG4 and CG4-1</p>  <p>High contact reliability by multiple cross-point contacts, CG4 with 1 μ and CG4-1 with 35 μ gold plating.</p>	<p>CGD4-1 CH11/CHR11 CH12/CHR12</p>  <p>High contact reliability by H-bridge design with "cross-wire" contacts. The contact system with gold-plated contacts (CH12/CHR12 with silver contact) allows for low voltages, electronic compatible.</p>
---	--	---

[< back to table of contents >](#)

Type	Size	Possible Switching Angles	Max. No. of Stages
CG4-CGD4-1	S00	30°, 45°, 60°, 90°	8
CG6-CHR6	S00	30°, 45°, 60°, 90°	4
CG8-CHR16	S0	30°, 45°, 60°, 90°	12
CG8B	S1	30°, 45°, 60°, 90°	12
CH10B-CHR16B	S1	30°, 45°, 60°, 90°	12
CG8S	S0	60°	on request

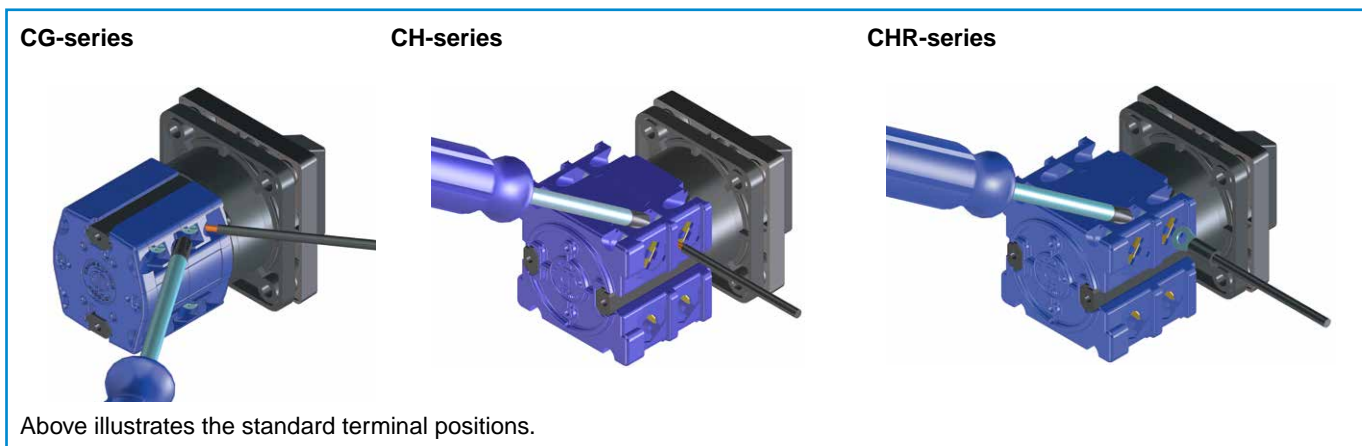

Nominal Ratings

[< back to table of contents >](#)

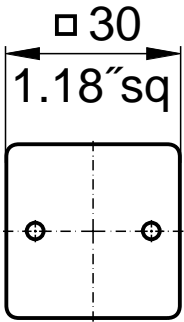
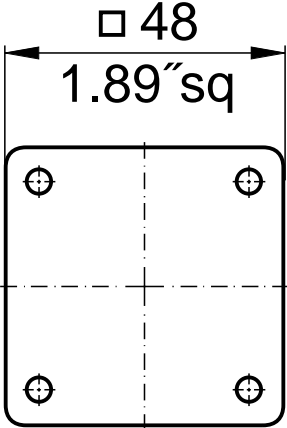
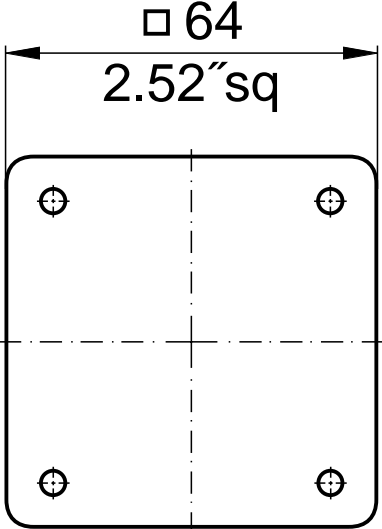
Switch Size	Type	According to IEC 60947-3, EN 60947-3, VDE 0660 part 107			
		Insulation Voltage ¹ U _i V	Thermal Current I _u /I _{th} A	Motor Rating 3 x 380 V-440 V AC-23A AC-3 kW kW	
S00 	CG4	440	10	3	2,2
	CG4-1	440	10	3	2,2
	CGD4-1	440	5	-	-
	CG6	690	20	7,5	5,5
	CH6	690	20	7,5	5,5
	CHR6	690	20	7,5	5,5
S0 	CG8	690	20	7,5	5,5
	CH10	690	20	7,5	5,5
	CH11	600	6	-	-
	CH12	600	6	-	-
	CH16	690	25	11	7,5
	CHR10	690	20	7,5	5,5
	CHR11	600	6	-	-
	CHR12	600	6	-	-
	CHR16	690	25	11	7,5
	S1 	CH10B	690	20	7,5
CH16B		690	25	11	7,5
CHR10B		690	20	7,5	5,5
CHR16B		690	25	11	7,5

For further technical details, refer to pages 36-38.

¹Valid for lines with grounded common neutral termination, overvoltage category III, pollution degree 3. Values for other supply systems on request.

How to order

Disconnectors and Main Switches according to IEC 60947-3 see Catalog 500

Three types of data (shown below) are required for ordering Blue Line cam-operated switches. Code numbers for ordering are shown in this catalog.

1. Type of Switch

The type of switch required may be easily selected by referring to the table on page 5 which shows the thermal current, power rating and dimensions of each switch. For further technical details, refer to pages 36-38. Variations of contacts and terminals are shown below.

2. Switch Function

The code numbers for standard switches shown on pages 8-25 indicate the switch function, escutcheon plate, handle and any optional extras.

Additional coding to modify type and color of handle and escutcheon plate is explained below.

3. Type of Mounting

Types of mounting are shown on pages 26-31. Catalog **101** describes enclosures and optional extras.

Specify the mounting code to indicate required mounting.

CH10

A202

VE

Type of Switch

Extending the switch type coding the following combinations will define:

Amendment	Definition	For switch types
-1	with gold contacts ¹	CG4-1, CGD4-1, CH10-1, CH10B-1, CH16B-1, CHR6-1, CHR10-1
-4 ²	with quick connects (nickel-plated)	CH10-4, CH10B-4, CH16-4, CH16B-4
-6 ²	with angled quick connects (nickel-plated)	CH10-6, CH10S-6, CH16-6
B	S0 switches with latching mechanism size S1	CH6-6, CH10-6, CH10S-6, CH16-6 CG8B, CH10B, CH11B, CH12B, CH16B, CH16B, CHR10B, CHR16B for four hole panel mounting
L	with lockout-relay w/o manual release	CH10L, CHR10L, CHR16L
M	with lockout-relay with manual release	CHR10M
X	with power failure release	CG8X
R	with spring return latching mechanism	CG8R, CH10R, CH11R, CHR10R, CHR11R
S	with snap action	CG8S, CH10S, CH16S, CHR10S, CHR16S with 60° or 90° switching
Y	with power failure release and trip-free release	CG8Y

Example: Coding for switch type **CH10** with latching mechanism size S1 is **CH10B**.

¹Technical data on request. ²Connection Diagrams on request.

Handles, Escutcheon Plates and Optional Extras

The handles for standard switches shown on pages 8-25 are suitable for mounting units with four hole mounting. Alternative types of handles available are illustrated on pages 26-31.

When a handle, escutcheon plate or optional extra is required but not covered by the dash number, the code number for the selected component should be entered separately. A comprehensive range of available standard escutcheon plates is illustrated on pages 32-34. Non-standard or special escutcheon plate engravings are available at extra cost. The large number of optional extras and enclosures is covered in Catalog **101**.

Switch Size

CG, CH and CHR switches are available in sizes S00, S0 and S1. These size codes indicate the dimension of the mounting, the escutcheon plate and the handle, as well as the size of optional devices and enclosures. Page 5 lists these sizes and the various switch types they include.

Notes:

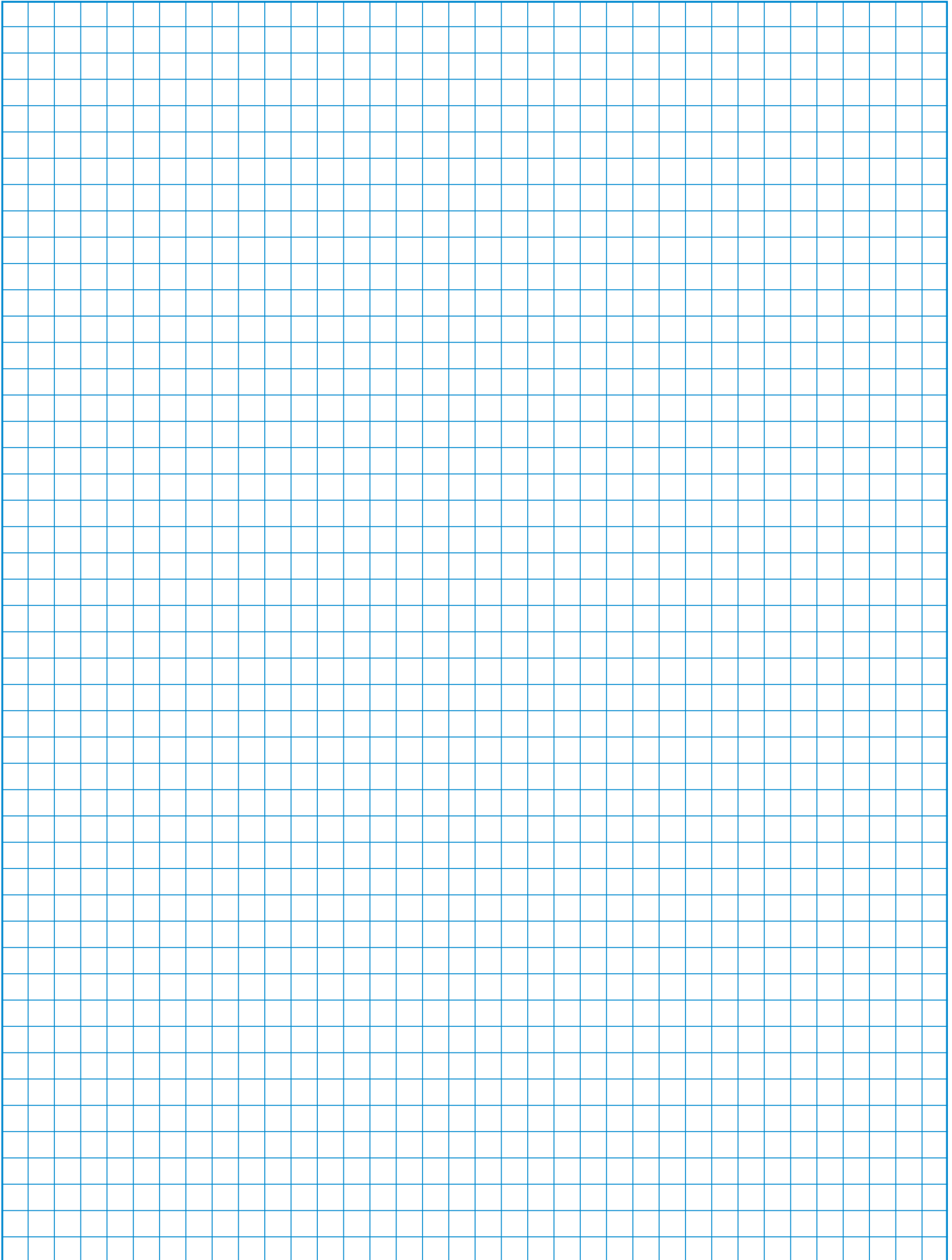

[< back to table of contents >](#)















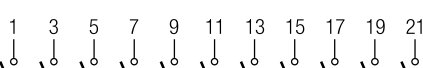









































Switch Function and Configuration

CG, CH, CHR Switches

Function	Escutch. Plate	Type/Handle				Code	Stages	Connection Diagram
		CG4- CGD4-1	CG6- CHR6	CH10- CHR16	CH10B- CHR16B			















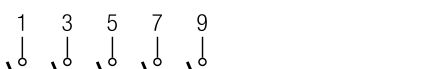





























ON/OFF Switches with 60° Switching

[Dimensions p. 46](#)





































1 pole	 F070					A200	1	
2 pole						A201	1	
3 pole						A202	2	
4 pole						A203	2	
4 pole 1 pole preclose 6° ¹						WAA653	2	
5 pole						WAA341	3	
6 pole						A342	3	
7 pole						A343	4	
8 pole						A344	4	
8 pole 2 pole preclose 6° ¹						WAA654	4	
9 pole						WAA345	5	
10 pole						A346	5	
11 pole					WAA347	6		
12 pole					A348	6		

ON/OFF Switches with 90° Switching

[< back to table of contents >](#)

1 pole contacts	 F056					A290	1	
2 pole preclose 30°						A291	1	
3 pole						A292	2	
4 pole						A324	2	
4 pole 1 pole preclose 60° ¹						A293	2	
4 pole 3 pole preclose 30°						WAA327	2	
5 pole contacts	 F062					WAA325	3	
6 pole preclose 30°						A326	3	
3 pole 360° rotation						WAA208	2	
3 pole for foot operation						WAA386	2	

ON/OFF Switches with 30° Switching

1 pole	 F169					WAA100	1	
2 pole						WAA101	1	
3 pole						WAA102	2	
4 pole						WAA103	2	
1 pole with spring return	 F153					A204	1	
2 pole with spring return						A205	1	
3 pole with spring return						WAA206	2	
4 pole with spring return						WAA207	2	

Switch Function and Configuration

CG, CH, CHR Switches

Function	Escutch. Plate	Type/Handle				Code	Stages	Connection Diagram ²
		CG4- CGD4-1	CG6- CHR6	CH10- CHR16	CH10B- CHR16B			

Double-throw Switches without „OFF“ 60° Switching

[Dimensions p. 46](#)

1 pole	<p>F072</p>					A220	1	
2 pole						A221	2	
3 pole						A222	3	
4 pole						A223	4	
4 pole 1 pole preclose 6° ¹						WAA673	4	
5 pole						A369	5	
6 pole						A370	6	
7 pole						A371	7	
8 pole						A372	8	
8 pole 2 pole preclose 6° ¹						WAA972	8	
9 pole						WAA373	9	
10 pole						WAA374	10	
11 pole					WAA375	11		
12 pole					WAA376	12		

[< back to table of contents >](#)

Double-throw Switches without „OFF“ with electrically isolated contacts

1 pole	<p>F072</p>					A720	1	
2 pole						A721	2	
3 pole						A722	3	
4 pole						A723	4	
4 pole 1 pole preclose 6° ¹						WAA973	4	
1 pole with spring return	<p>F026</p>					A795	1	

Double-throw Switches without „OFF“ 30° Switching

1 pole	<p>F026</p>					WAA120	1	
2 pole						WAA121	2	
3 pole						WAA122	3	
4 pole						WAA123	4	
1 pole with spring return	<p>F026</p>					A295	1	
2 pole with spring return						A296	2	
3 pole with spring return						WAA297	3	

¹For use in a three phase four-wire system with switched neutral. ²Connection diagrams for CHR switches on request.

Switch Function and Configuration

CG, CH, CHR Switches

Function	Escutch. Plate	Type/Handle				Code	Stages	Connection Diagram ²
		CG4- CGD4-1	CG6- CHR6	CH10- CHR16	CH10B- CHR16B			

Double-throw Switches with Center „OFF“ 60° Switching

[Dimensions p. 46](#)

1 pole	<p>F071</p>					A210	1		
2 pole						A211	2		
3 pole						A212	3		
4 pole						A213	4		
4 pole 1 pole preclose 6° ¹						WAA913	4		<p>1-4 pole</p>
5 pole						A361	5		
6 pole						A362	6		
7 pole						WAA363	7		
8 pole						WAA364	8		
8 pole 2 pole preclose 6° ¹						WAA664	8		<p>4 pole 1 pole preclose 6°</p>
							<p>5 pole</p>		
							<p>6 and 7 pole</p>		
							<p>8 pole</p>		
							<p>8 pole 2 pole preclose 6°</p>		

[< back to table of contents >](#)

Double-throw Switches with Center „OFF“ 90° Switching

1 pole	<p>F057</p>					A218	1	<p>1-4 pole</p>
2 pole						A219	2	
3 pole						WAA299	3	
4 pole 1 pole preclose 6° ¹						WAA294	4	

Double-throw Switches with Center „OFF“ and electrically isolated contacts

1 pole	<p>F071</p>					A710	1	<p>1-4 pole</p>
2 pole						A711	2	
3 pole						A712	3	
4 pole 1 pole preclose 6° ¹						A713	4	
4 pole					WAA963	4		
1 pole with spring return to center	<p>F025</p>					A714	1	<p>1 and 2 pole</p>
2 pole						A715	2	

¹For use in a three phase four-wire system with switched neutral. ²Connection diagrams for CHR switches on request.











Switch Function and Configuration

CG, CH, CHR Switches

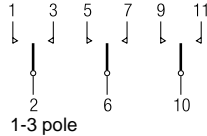





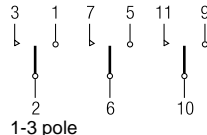







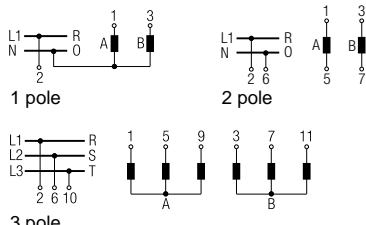





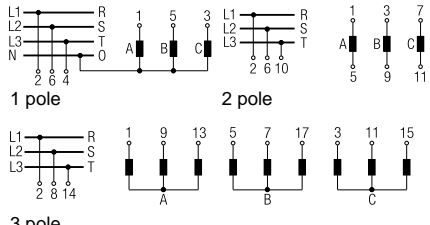

Function	Escutch. Plate	Type/Handle				Code	Stages	Connection Diagram ¹
		CG4- CGD4-1	CG6- CHR6	CH10- CHR16	CH10B- CHR16B			

Double-throw Switches with Spring Return to Center

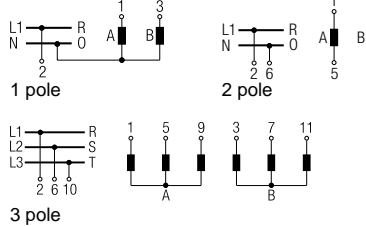
[Dimensions p. 46](#)

1 pole with spring return to center 2 pole 3 pole	 F025					A214 A215 A216	1 2 3	
1 pole with spring return from left to center 2 pole 3 pole	 F361					A320 A321 A322	1 2 3	

General Application Switches

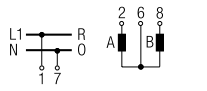
1 pole 2 Gang 2 pole Switching sequence: 3 pole 0, A, A+B	 F075					A310 A312 WAA314	1 2 3	
1 pole 3 Gang 2 pole Switching sequence: 3 pole 0, A, A+B, A+B+C	 F001					A311 WAA313 WAA315	2 3 5	
1 pole 2 Gang 2 pole Series switching 3 pole Switching sequence: 0, A, B, A+B	 F001					WAA330 WAA331 WAA332	1 2 3	
2 pole 2 Gang Series-parallel Switching Switching sequence: 0, A+B series, A, A+B parallel	 F001					WAA339	2	

¹Connection diagrams for CHR switches on request.

Switch Function and Configuration













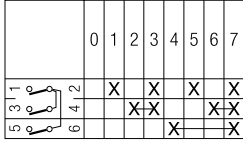



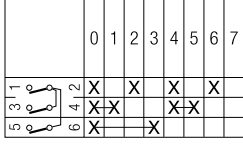



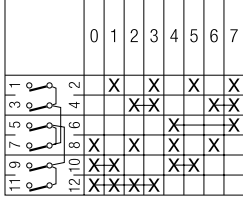



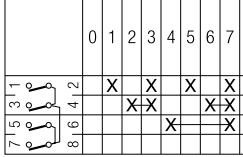



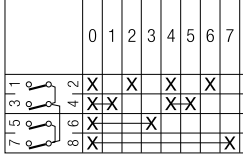

CG, CH, CHR Switches

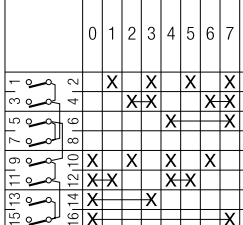
Function	Escutch. Plate	Type/Handle				Code	Stages	Connection Diagram
		CG4- CGD4-1	CG6- CHR6	CH11 CH12	CH10B- CHR16B			

Coding Switches/Binary Code

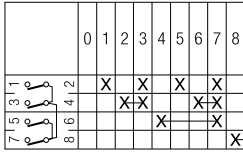
[Dimensions p. 46](#)

[< back to table of contents >](#)

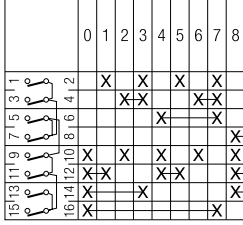
0 - 7 360° rotation	 F322			A540	2	
0 - 7 complement 360° rotation	 F322			WAA541	2	
0 - 7 + complement 360° rotation	 F322			WAA542	3	
0 - 9	 F007			A550	2	
0 - 9 complement	 F007			WAA551	2	
0 - 9 + complement	 F007			WAA552	4	
0 - 11 360° rotation	 F009			WAA543	2	
0 - 11 + complement 360° rotation	 F009			WAA545	4	











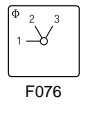



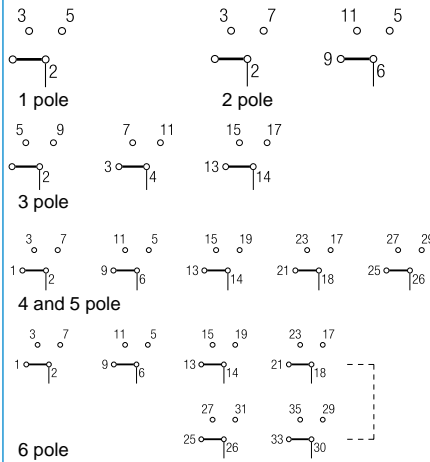
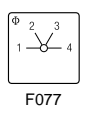



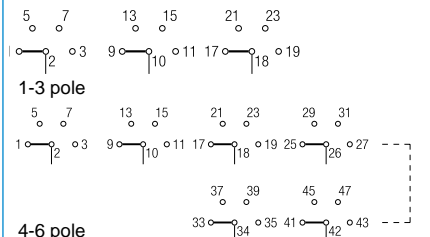





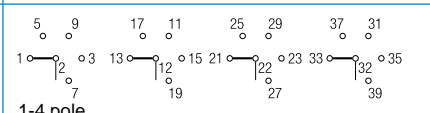
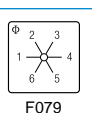



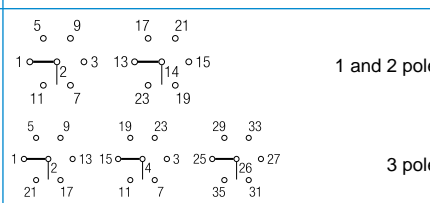
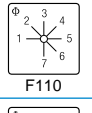



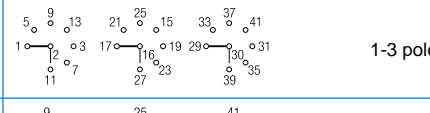
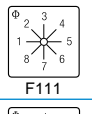



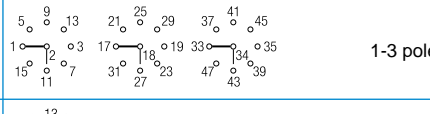
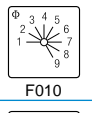



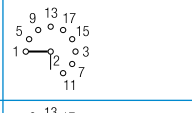
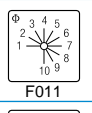

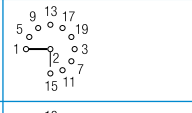
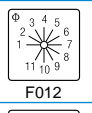

Switch Function and Configuration

CG, CH, CHR Switches

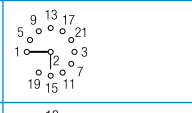
Function	Escutch. Plate	Type/Handle				Code	Stages	Connection Diagram ¹
		CG4- CGD4-1	CG6- CHR6	CH10- CHR16	CH10B- CHR16B			

Multi-step Switches without „OFF“

[Dimensions p. 46](#)

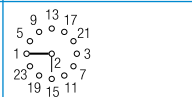
1 pole 3 Step 2 pole 3 pole 4 pole 5 pole 6 pole						A230 A250 A270 A476 WAA484 WAA489	2 3 5 6 8 9	 <p>1 pole</p> <p>2 pole</p> <p>3 pole</p> <p>4 and 5 pole</p> <p>6 pole</p>
1 pole 4 Step 2 pole 3 pole 4 pole 5 pole 6 pole						A231 A251 A271 A477 WAA485 WAA490	2 4 6 8 10 12	 <p>1-3 pole</p> <p>4-6 pole</p>
1 pole 5 Step 2 pole 3 pole 4 pole						A232 A252 WAA272 WAA478	3 5 8 10	 <p>1-4 pole</p>
1 pole 6 Step 2 pole 3 pole						A233 WAA253 WAA273	3 6 9	 <p>1 and 2 pole</p> <p>3 pole</p>
1 pole 7 Step 2 pole 3 pole						WAA234 WAA254 WAA274	4 7 11	 <p>1-3 pole</p>
1 pole 8 Step 2 pole 3 pole						WAA235 WAA255 WAA275	4 8 12	 <p>1-3 pole</p>
1 pole 9 Step						WAA236	5	
1 pole 10 Step						WAA237	5	
1 pole 11 Step						WAA238	6	
1 pole 12 Step 1 pole 360° rotation						WAA239 WAA639	6 6	

[< back to table of contents >](#)

¹Connection diagrams for CHR switches on request.

Switch Function and Configuration

CG, CH, CHR Switches

Function	Escutch. Plate	Type/Handle				Code	Stages	Connection Diagram ¹
		CG4- CGD4-1	CG6- CHR6	CG8- CH10- CHR16	CH10B- CHR16B			

Multi-step Switches without „OFF“ with electrically isolated contacts [Dimensions p. 46](#)

1 pole 3 Step						A730	2	
2 pole						A750	3	
1 pole 4 Step						A731	2	
2 pole						A751	4	

[< back to table of contents >](#)

Multi-step Switches with „OFF“

1 pole 2 Step 2 pole 3 pole 4 pole 5 pole 6 pole						A240 A260 A280 WAA480 WAA486 WAA491	1 2 3 4 5 6	
1 pole 3 Step 2 pole 3 pole 4 pole 5 pole						A241 A261 A281 WAA481 WAA487	2 3 5 6 8	

¹Connection diagrams for CHR switches on request.



























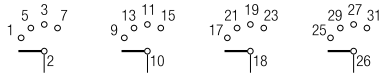



























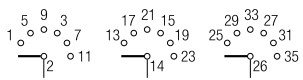



























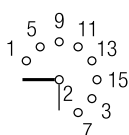













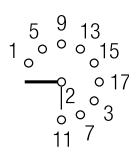













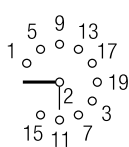



Switch Function and Configuration

CG, CH, CHR Switches

Function	Escutch. Plate	Type/Handle				Code	Stages	Connection Diagram ¹
		CG4- CGD4-1	CG6- CHR6	CH10- CHR16	CH10B- CHR16B			

Multi-step Switches with „OFF“

[Dimensions p. 46](#)

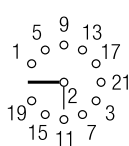
1 pole 4 Step 2 pole 3 pole 4 pole	 F002	   	   	   	   	A242 WAA262 WAA282 WAA482	2 4 6 8	 1-4 pole
1 pole 5 Step 2 pole 3 pole	 F003	  	  	  	  	A243 WAA263 WAA283	3 5 8	 1-3 pole
1 pole 6 Step 2 pole 3 pole	 F004	 	 	   	   	A244 WAA264 WAA284	3 6 9	 1-3 pole
1 pole 7 Step 2 pole	 F005	 	 	   	   	WAA245 WAA265	4 7	 1 pole 2 pole
1 pole 8 Step	 F006	 	 	   	   	WAA246	4	
1 pole 9 Step	 F007	 	 	   	   	WAA247	5	
1 pole 10 Step	 F008	 	 	   	   	WAA248	5	
1 pole 11 Step 1 pole 360° rotation	 F009	 	 	   	   	WAA249 WAA649	6 6	

[< back to table of contents >](#)

¹Connection diagrams for CHR switches on request.











Switch Function and Configuration

CG, CH, CHR Switches

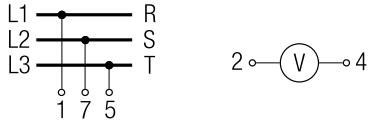





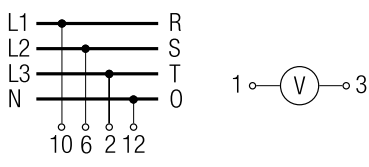



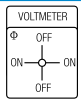



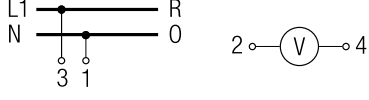

Function	Escutch. Plate	Type/Handle				Code	Stages	Connection Diagram ¹
		CG4- CGD4-1	CG6- CHR6	CH10- CHR16	CH10B- CHR16B			

Voltmeter Switches without „OFF“

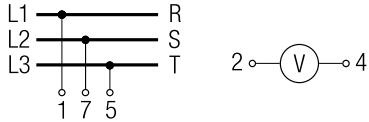
[Dimensions p. 46](#)

3 phase 3 wire	 F792					A023	2	
3 phase 3 wire 3 phase to phase and phase to neutral	 F794					A025	3 3	

Voltmeter Switches with „OFF“

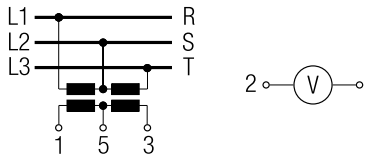
2 pole 360° rotation	 F170-PRL					WAA002	1	
3 phase 3 wire	 F775					A004	2	
	 F212-PRL					WAA011	2	

¹Connection diagrams for CHR switches on request.















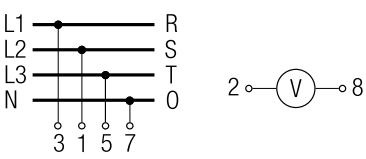





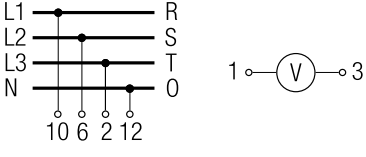

Switch Function and Configuration

CG, CH, CHR Switches

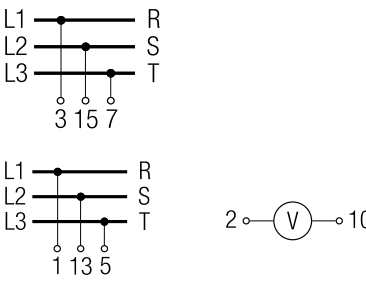
Function	Escutch. Plate	Type/Handle				Code	Stages	Connection Diagram ¹
		CG4- CGD4-1	CG6- CHR6	CH10- CHR16	CH10B- CHR16B			

Voltmeter Switches with „OFF“

[Dimensions p. 46](#)

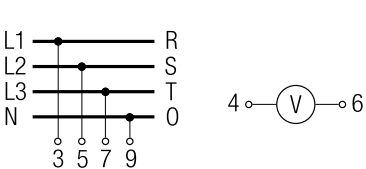
3 phase to neutral	 F779					WAA005	2	
3 phase to phase and 3 phase to neutral	 F782					A007	3	
2 separate 3 phase with center „OFF“	 F786					WAA008	4	
3 phase and 1 phase to neutral	 F789					WAA010		

¹Connection diagrams for CHR switches on request.

[< back to table of contents >](#)













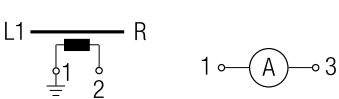
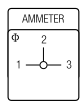

Switch Function and Configuration

CG, CH, CHR Switches

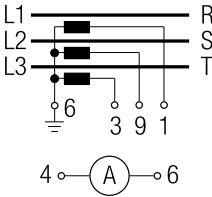
Function	Escutch. Plate	Type/Handle				Code	Stages	Connection Diagram ¹
		CG4- CGD4-1	CG6- CHR6	CH10- CHR16	CH10B- CHR16B			

Ammeter Switches

[Dimensions p. 46](#)

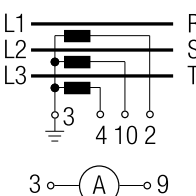
Single pole with one current transformer	 F058					WAA046	1	
Single pole with 3 current transformers without „OFF“	 F181-PRL					WAA017		
Single pole with 3 current transformers with „OFF“ 360° rotation	 F059					A048	3	

¹Connection diagrams for CHR switches on request.











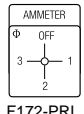



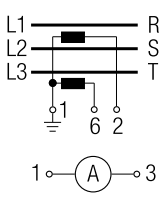
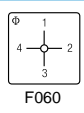



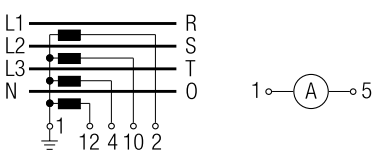
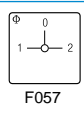



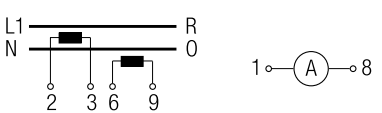
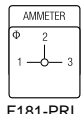

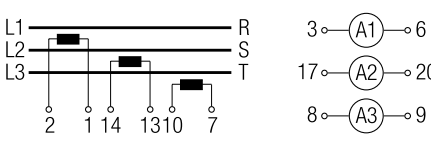

Switch Function and Configuration

CG, CH, CHR Switches

Function	Escutch. Plate	Type/Handle				Code	Stages	Connection Diagram ¹
		CG4- CGD4-1	CG6- CHR6	CH10- CHR16	CH10B- CHR16B			

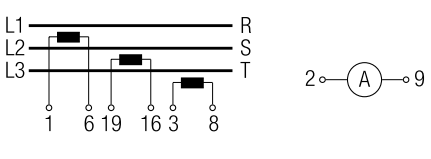
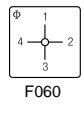
Ammeter Switches

[Dimensions p. 46](#)

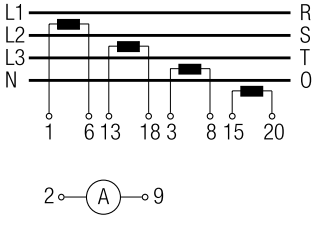
Single pole with 2 current transformers (3 readings)	 F172-PRL					WAA021	2	
Single pole with 4 current transformers	 F060					WAA036	4	
2 pole 2 current transformers	 F057					WAA037	3	
2 pole 3 current transformers	 F181-PRL					WAA019	5	
	 F059					A038	5	
2 pole 4 current transformers	 F060					WAA039	6	

[< back to table of contents >](#)

¹Connection diagrams for CHR switches on request.















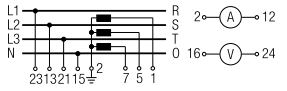







Switch Function and Configuration

CG, CH, CHR Switches

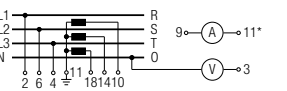













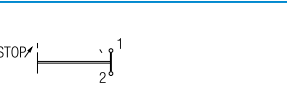











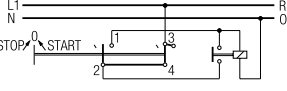





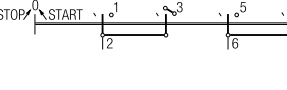

Function	Escutch. Plate	Type/Handle				Code	Stages	Connection Diagram ¹
		CG4- CGD4-1	CG6- CHR6	CH10- CHR16	CH10B- CHR16B			

Volt-ammeter Switches

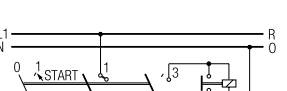
Dimensions p. 46

3 phase - phase to phase 3 current	 F101					WAA027	6	
	 F077					WAA028	7	
3 phase voltage 3 phase current 4 wire	 F174-PRL					WAA033	5	
3 phase voltage 3 phase current 3 wire	 F174-PRL					WAA035	5	

Control Switches

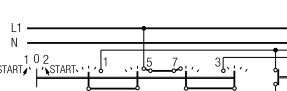
Stop switch	 F022					WAA174	1	
Start switch	 F023					A175	1	
Stop start switch single pole	 F024					A176	1	
Stop start switch 2 pole	 F024					WAA183	2	
Stop start switch with spring return from start to run	 F119					A178	1	
Stop start switch with spring return to run for 2 units	 F121					WAA177	2	

¹Connection diagrams for CHR switches on request.











Switch Function and Configuration

CG, CH, CHR Switches

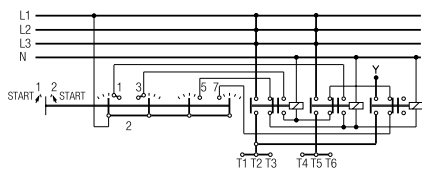





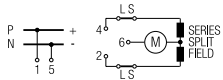







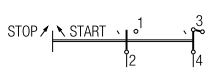





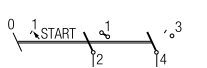





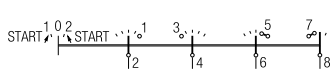

Function	Escutch. Plate	Type/Handle				Code	Stages	Connection Diagram
		CG4- CGD4-1	CG6- CHR6	CH10- CHR16	CH10B- CHR16B			

Control Switches

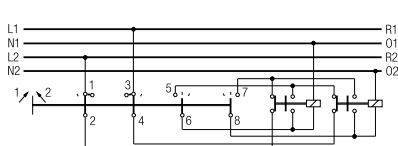





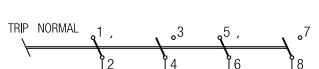



Dimensions p. 46

Stop start switch with spring return to run with contactor interlock contactors for 2 units						WAA182	2	
Motor voltage control switch						WAA150	2	

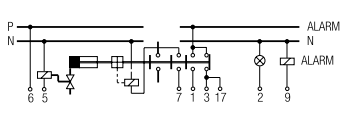
Control Switches with electrically isolated contacts

Stop start switch 1 pole						A789	1	
Stop start switch with spring return to 1						A791	1	
Stop start switch with spring return to run for 2 units						WAA790	2	
Contactor control with spring return to „OFF“						WAA179	2	
Circuit breaker control						WAA537	2	

Control and Alarm Switches¹

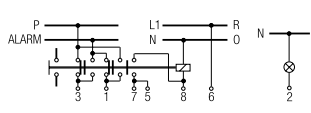
With slip clutch and without indicator device						WAA190	5 ²	
Without indicator device						WAA192	2	

¹Advise the indicator device, described in Catalog 101, page 9. ²incl. slip clutch











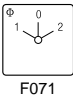



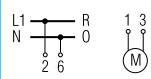
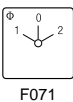

Switch Function and Configuration

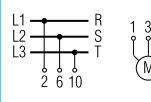
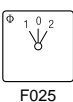
CG, CH, CHR Switches



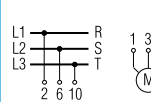
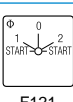



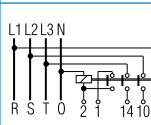

Function	Escutch. Plate	Type/Handle				Code	Stages	Connection Diagram ¹
		CG4- CGD4-1	CG6- CHR6	CH10- CHR16	CH10B- CHR16B			

Motor Reversing Switches

[Dimensions p. 46](#)

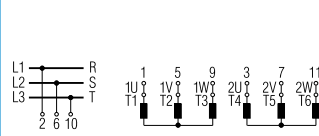
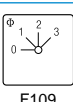
2 pole						A400	2	
3 pole						A401	3	
3 pole with spring return to „OFF“						A228	3	
3 pole for use with reversing contactors						WAA402	4	

Motor Control Switches

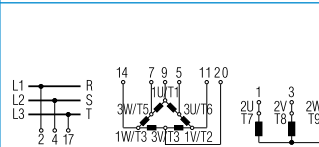
2 speed 2 winding 0-A-B Υ or Δ						WAA451	3	
3 speed 2 winding 0-A Δ -B Υ -A $\Upsilon\Upsilon$						WAA457	6	

¹Connection diagrams for CHR switches on request.











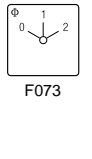

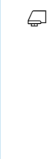

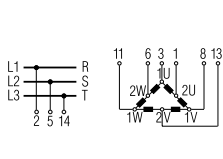
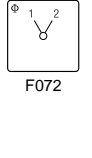

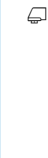

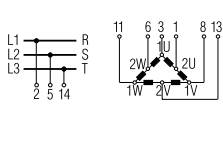
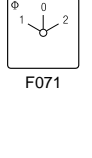

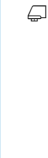

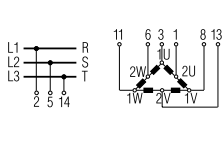
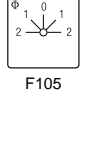

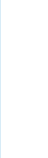
Switch Function and Configuration

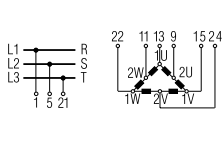
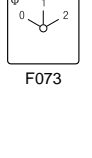
CG, CH, CHR Switches

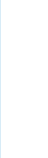
Function	Escutch. Plate	Type/Handle				Code	Stages	Connection Diagram ¹
		CG4- CGD4-1	CG6- CHR6	CH10- CHR16	CH10B- CHR16B			

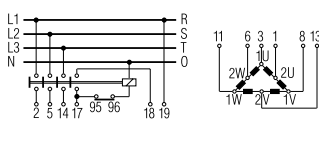
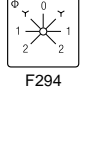
Motor Control Switches

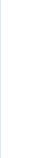
[Dimensions p. 46](#)

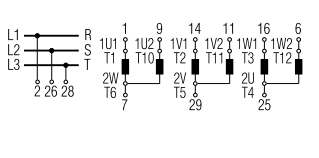
2 speed single winding						A440	4	
2 speed single winding without „OFF“						A466	4	
2 speed single winding with center „OFF“						A441	4	
2 speed single winding reversing						A442	6	
2 speed single winding for use with contactors						WAA444	5	
2 speed reversing for 2 way operation with slip clutch for „OFF“ load use						WAA468	10 ²	

¹Connection diagrams for CHR switches on request. ²incl. slip clutch

[< back to table of contents >](#)















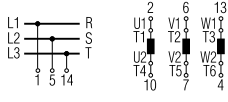





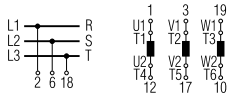

Switch Function and Configuration

CG, CH, CHR Switches

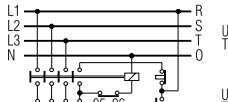
Function	Escutch. Plate	Type/Handle				Code	Stages	Connection Diagram ¹
		CG4- CGD4-1	CG6- CHR6	CH10- CHR16	CH10B- CHR16B			





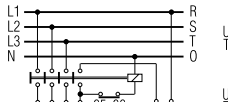









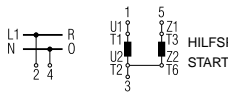

Star-delta Switches

[Dimensions p. 46](#)

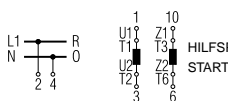
OFF-star-delta	 F080					A410	4	
Reversing	 F112					WAA413	5	
With auxiliary contact closed in „OFF“ position	 F080					WAA416	5	
For use with reversing contactors	 F061					A419	4	

[< back to table of contents >](#)

Start and Run Switches

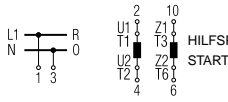

Split-phase start	 F119					A425	2	
Split-phase start reversing	 F120					WAA426	3	
Split-phase reversing auto cutout of start field winding	 F104					WAA622	3	

¹Connection diagrams for CHR switches on request.

Mounting

CG, CH, CHR Switches

Two or Four Hole Panel Mounting	Terminals rotated 90°	Code	CG4-CHR6	CG8-CHR16	CH10B-CHR16B
---------------------------------	-----------------------	------	----------	-----------	--------------

Panel mounting						
	<p>Two hole panel mounting, Protection IP 40</p> <p>Two hole panel mounting, Protection IP 66/67/69k</p>	<p>●</p> <p>●</p>	<p>E</p> <p>E-V</p> <p>EF</p> <p>EF-V</p>	<p>●</p> <p>●</p> <p>●</p> <p>●</p>		
	<p>Four hole panel mounting, Protection IP 40</p> <p>Four hole panel mounting, Protection IP 66/67/69k</p> <p>Two hole panel mounting, Protection IP 66/67/69k</p>	<p>●</p> <p>●</p> <p>●</p>	<p>E</p> <p>E-V</p> <p>EF</p> <p>EF-V</p> <p>E22</p> <p>E22-V</p>	<p>●</p> <p>●</p> <p>●</p> <p>●</p> <p>●</p> <p>●</p>	<p>●</p> <p>●</p> <p>●</p> <p>●</p>	<p>●</p> <p>●</p> <p>●</p>
	<p>Panel mounting using larger escutcheon plate and handle and with heavy duty latching</p> <p>Four hole panel mounting, Protection IP 40</p> <p>Four hole panel mounting, Protection IP 66/67/69k</p>		<p>EG</p> <p>EGF</p>	<p>●</p> <p>●</p>		

< back to table of contents >

Two Hole Panel Mounting or Mosaic Mounting	Code	CG4-CHR6
--	------	----------

Panel mounting with round shaft for combining with commercial radio knobs



Two hole panel mounting, Protection IP 40
Shaft diam. 6 mm/.24 inch

E9



Two hole panel mounting, Protection IP 40
Shaft diam. 6,35 mm/.25 inch

E91



Mosaic mounting

For Siemens-Mosaic 30 mm grid depth, Protection IP 40

E92



For Subklew-, Kreutzenbeck-, Symo-Mosaic, Protection IP 40
28 mm 25 mm 25 mm grid depth

E93



For Mauell-Mosaic 30 mm grid depth, Protection IP 40

E94





< back to table of contents >

Mounting

CG, CH, CHR Switches

Two or Four Hole Panel Mounting	Code	CG8-CHR16	CH10B-CHR16B
--	-------------	-----------	--------------

	<p>Panel mounting with heavy duty latching and metal shaft</p> <p>Four hole panel mounting, Protection IP 40 Mounting plate, escutcheon plate and handle of size S0</p>	KN2	●	
	<p>Four hole panel mounting, Protection IP 40 Mounting plate, escutcheon plate and handle of size S1</p>	KN1	●	●
	<p>Four hole panel mounting, Protection IP 40 Mounting plate, escutcheon plate and handle of size S1 and 6 mm square metal shaft</p>	KD1	●	●
<p>Panel mounting with protective cover</p>				
	<p>Four hole panel mounting Protection front IP 40 rear IP 30</p>	EC	CH CHR	●
	<p>Four hole panel mounting with additional shaft seal Protection front IP 65 rear IP 30</p>	ED	CH CHR	●
	<p>Four hole panel mounting Protection front IP 40 rear IP 42</p>	EC1		●
	<p>Four hole panel mounting with additional shaft seal Protection front IP 66/67/69k rear IP 42</p> <p>Two hole panel mounting Protection front IP 66/69k rear IP 42</p>	ED1		●
		ED22	●	





[< back to table of contents >](#)

Mounting

CG, CH, CHR Switches

Single Hole Mounting	Terminals rotated 90°	Code	CG4-CHR6	CG8-CHR16



[< back to table of contents >](#)

			mm	mm
 <p>With locking nut and shaft seal</p> <p>Without escutcheon plate, Protection IP 66/67/69k</p>	●	FS1 FS1-V	16/22 16/22	
	●	FT1 FT1-V		22 22
	●	FT3 FT3-V		22/30 22/30
 <p>With square escutcheon plate, Protection IP 66/67/69k</p>	●	FS2 FS2-V	16/22 16/22	
	●	FT2 FT2-V		22 22
	●	FT4 FT4-V		22/30 22/30
<p>With size S1 square escutcheon plate and heavy duty latching, Protection IP 66/67/69k</p>	●	FH3 FH3-V		22 22
 <p>With rectangular escutcheon plate, Protection IP 66/67/69k</p>	●	FS4 FS4-V	16/22 16/22	
	●	FT6 FT6-V		22 22
<p>With size S1 rectangular escutcheon plate and heavy duty latching, Protection IP 66/67/69k</p>	●	FH4 FH4-V		22 22
 <p>Mounting key for locking nut</p>		S00 T170 09		

Mounting

CG, CH, CHR Switches

Base Mounting	Terminals rotated 90°	Code	CG4- CGD4-1	CG8- CHR16
---------------	-----------------------	------	----------------	---------------

Base mounting					
	<p>Base mounting - four hole, Protection IP 40</p>	●	VE VE-V		● ●
	<p>For four hole base mounting and with integrated simplified door clutch, Protection IP 65</p>	●	VF VF-V		● ●
	<p>For two hole base mounting, Protection IP 40</p>	●	VE22 VE22V		● ●
	<p>For two hole base mounting and with integrated simplified door clutch, Protection IP 65</p>	●	VF22 VF22V		● ●
	<p>Snap-on base mounting for track EN 60715, Protection IP 40</p>		VE1		●
	<p>Snap-on base mounting for track EN 60715, Escutcheon plate can be fastened by screws at the switch, Protection IP 40</p>		VE1E	●	●
	<p>Snap-on base mounting for track EN 60715, Escutcheon plate fastened by single hole mounting at the switch e.g. for combining with key-lock device, Protection IP 66/67/69k</p>		VE1F	●	●

[< back to table of contents >](#)

Mounting

CG, CH, CHR Switches

Base Mounting	Code	CG4- CGD4-1	CG8- CHR16
----------------------	-------------	----------------	---------------

Base mounting



Snap-on base mounting for track EN 60715 with rectangular escutcheon plate for 45 mm standard knock-out, Protection IP 40

VE2



Snap-on base mounting for track EN 60715, both the escutcheon plate for 45 mm standard knock-out and the handle are adjustable in height, Protection IP 40

VE21



< back to table of contents >

Face plates

60° switching

F707	F087	F088	F089	F133	F197	F198	F232	F243	F247	F263	F268	F310	F311	F323	F328	F352	F367
F379	F380	F470	F754	F072	F163	F164	F192	F193	F196	F230	F231	F234	F244	F257	F262	F264	F282
F288	F291	F313	F382	F441	F705	F721	F722	F750	F757	F758	F075	F076	F098	F220	F223	F356	F357
F377	F723	F071	F073	F080	F081	F085	F086	F090	F091	F092	F093	F094	F104	F194	F235	F237	F239
F240	F241	F249	F260	F269	F274	F281	F290	F292	F312	F314	F315	F316	F324	F331	F344	F354	F358
F359	F364	F370	F371	F373	F381	F385	F442	F444	F469	F732	F735	F759	F077	F100	F101	F102	F309
F342	F343	F361	F362	F363	F365	F366	F078	F191	F325	F326	F720	F074	F082	F096	F097	F195	F724
F256	F079	F083	F084	F095	F099	F185	F190	F199	F233	F236	F238	F242	F283	F725	F730	F731	F736
F737																	

< back to table of contents >

90° switching

F056	F063	F068	F134	F201	F251	F252	F346	F456	F058	F065	F069	F177	F178	F182	F208	F253	F254
F340	F360	F378	F458	F443	F700	F743	F057	F061	F064	F067	F171	F181	F205	F207	F209	F320	F349
F437	F445	F715	F719	F059	F060	F062	F066	F170	F172	F173	F174	F175	F176	F179	F180	F186	F188
F202	F204	F206	F250	F265	F266	F286	F318	F327	F338	F339	F425	F716	F717	F718	F726	F733	F751
F755	F756																

Miscellaneous

F119	F130	F122	F126	F125	F129	F225	F248	F261	F341	F345	F287	F123	F127	F145	F146	F148	F706						
F707	F245	F120	F124	F128	F131	F121	F132	F749										F990	F991	F801	F802	F803	F804
F805	F806	F807	F808	F809	F810	F811	F812	F813	F814	F815	F816	F817	F818	F819	F820	F821	F822						
F823	F824	F825	F826	F827	F828	F829	F830	F831	F832	F833	F834	F835	F837	F838	F839	F840	F841						

¹INTERRUPTEUR PRINCIPAL, OUVERTURE EN POSITION 0 ²INTERRUPTORE GENERALE, APRIRE SOLO CON MANIGLIA SU 0 ³INTERRUPTOR PRINCIPAL, ABRIR ARMARIO SOLO EN POS. "0"

Handles

Type	Color	Code	Size		
			S00	S0	S1









Type	Color	Code	Size		
			S00	S0	S1

<p>R-Handle</p> 	black red	G001 G002	— —	● ●	● ●
<p>F-Handle</p> 	black red	G221 G222	● ●	● ●	● ●
<p>S-Handle</p>  <p>S0 S1</p>	black red	G301 G302	— —	● ●	● ●
<p>P-Handle</p>  <p>S0 S1</p>	black red	G211 G212	— —	● ●	● ●
<p>O-Handle</p> 	black red	G321 G322	— —	— —	● ●

<p>I-Handle</p>  <p>S00 S0, S1</p>	black red	G251 G252	● ●	● ●	● ●
<p>B-Handle</p> 	black red	G521 G522	— —	● ●	● ●
<p>L-Handle</p> 	black red	G501 G502	— —	— —	● ●
<p>K-Handle</p> 	black red	G411 G412	— —	— —	● ●

[< back to table of contents >](#)

International Standards and Approvals

Country	Authority	Mark or Standard					CH6		CHR6	
			CG4	CG4-1 CGD4-1	CG6	CG8	CH10 CH11 CH12 CH10B	CH16 CH16B	CHR10 CHR11 CHR12 CHR10B	CHR16 CHR16B
SA	Underwriters Laboratories	 ¹						●	●	
		 ² ³	●	●	●	●	●	●		
Canada	Canadian Standards Association	 ⁵	●	CG4-1	●	●	●	●	●	
		 ¹						●	●	
		 ² ³	●	●			●	●		
International Electrical Commission (IEC) Recommendation		EC 60947 ⁴	+	+	+	+	+	+	+	
China	China Quality Certification Centre	 GB/T14048.3	●	CG4-1			CH10 CH10B	●	CHR10 CHR10B	●
Russia Belarus Kazakhstan	Eurasian Conformity		●	● +	●	●	●	●	●	●
Lloyds Register EMEA							CH10 CH10B	●		
● Switch approved + Switch conforms to requirements										
¹ Approved under the "Component Program" (UL-Recognized Industrial Component). File No. E35541, Category Control No. NLRV2 (U.S.) and NLRV8 (Canada) resp. File No. E60262, Category Control Number NRNT2 (U.S.) and NRNT8 (Canada). ² Approved under the "Listing Program". File No. E35541, Category Control No. NLRV (U.S.) resp. NLRV7 (Canada). ³ Switch types CGD4-1, CH11, CH12, CHR11, CHR12 approved under the "Listing Program". File No. E60262, Category Control No. NRNT (U.S.) resp. NRNT7 (Canada). ⁴ IEC does not operate an approval scheme. ⁵ File No. 13002, Class No. 3211-05 resp. 4652-04.										

[< back to table of contents >](#)

Technical Data

CG, CH, CHR Switches

Selection Data	CG4	CG6	CH6	CHR6		
	CG4-1	CG8	CH10 CH10B	CHR10 CHR10B	CH16 CH16B	CHR16 CHR16B

Rated Insulation Voltage U_e	IEC 60947-3, EN 60947-3 ¹ VDE 0660 part 107 ¹	V	440	690	690	690	690	690	
	SEV max.	V	400	690	–	–	–	–	
	UL/Canada ²	V	300	300	600	600	600	600	
	CEE 24	V	380	380	–	–	–	–	
	min. voltage	V			on request				
Rated Impulse Withstand Voltage U_{imp}^1		kV	4	6	6	6	6	6	
Rated Thermal Current I_u/I_{th}	IEC 60947-3, EN 60947-3 VDE 0660 part 107	A	10	20	20	20	25	25	
	SEV max.	A	10	20	–	–	–	–	
	UL/Canada	A	10	16	20	20	25	25	
Rated Operational Current I_e									
AC-21A	Switching of resistive loads, including moderate overloads	IEC 60947-3, EN 60947-3 VDE 0660 part 107	A	10	20	20	20	25	25
AC-1	Resistive or low inductive loads	SEV 400 V	A	10	–	–	–	–	–
		500 V	A	–	–	–	–	–	–
		600 V	A	–	–	–	–	–	–
AC-22A	Switching of combined resistive or low inductive loads including moderate overloads	IEC 60947-3 220 V-440 V	A	10	20	20	20	25	25
		VDE 0660, 500 V	A	–	20	20	20	25	25
		part 107 660 V-690 V	A	–	16	16	16	25	25
AC-15	Switching of control devices, contactors, valves etc.	IEC 60947-5, EN 60947-5-1 110 V	A	2,5	6	5	5	8	8
		VDE 0660, 220 V-240 V	A	2,5	5	5	5	8	8
		part 200 380 V-440 V	A	1,5	4	4	4	5	5
Pilot Duty	UL/Canada ² Heavy		A300	A300	A600	A600	A600	A600	
Ampere Rating	UL/Canada ²	A	10	16 (150 V) 10 (300 V)	20	20	25	25	
Resistive load/Motor load	CEE 24 ² NEMKO/FI ²	A	4/2	10/6	–	–	–	–	
		A	6/4 ⁴	10/6	–	–	–	–	
Breaking capacity	220 V-240 V	A	50	150	150	150	200	200	
	380 V-440 V	A	50	150	150	150	200	200	
	660 V-690 V	A	–	80	80	80	125	125	
Power loss per contact at I_u		W	0,4/0,7	0,8	1,4	1,4	2,3	2,3	
Resistance to vibration					on request				
Resistance to shock					min. 5 g, 30 ms				
Short Circuit Protection									
Max. fuse size	(gG-characteristic)	A	10	25	25	25	35	35	
Rated short-time withstand current	(1s-current)	A	90	140	200	200	250	250	
DC Switching Capacity⁶			Rated Operational Current I_e						
No. of series contacts	1 2 3 4 5 6 8	A	CG4	CG6	CH6	CHR6			
	Voltage V		CG4-1	CG8	CH10 CH10B	CHR10 CHR10B	CH16 CH16B	CHR16 CHR16B	
Resistive loads $T \leq 1$ ms	24 48 70 95 120 145 190		10	20	20	20	25	25	
	48 95 140 190 240 290 350		6	12	16	12	12	20	
	60 120 180 240 300 360 450		2,5	4,5	8	4,5	4,5	7,5	
	110 220 330 440 550 660 –		0,7	1	2	1	1,5	1,5	
	220 440 660 – – – –		0,3	0,4	0,6	0,4	0,5	0,5	
440 660 – – – –		0,2	0,27	0,35	0,27	0,27	0,3		
Inductive loads $T = 50$ ms	24 48 70 95 120 145 190		6	12	20	12	12	20	
	30 60 90 120 150 180 240		3	5	13	5	9	9	
	48 95 140 190 240 290 350		1	2	6	2	3	3	
	60 120 180 240 300 360 450		0,7	1	3	1	1,5	1,5	
	110 220 330 440 550 660 –		0,3	0,4	1	0,4	0,5	0,5	
Min. Ambient Temperature of Stages			-25 °C (valid only without optional extra)						
Max. Ambient Temperature of Stages^{5,7}			55 °C during 24 hours with peaks up to 60 °C						
			35 °C during 24 hours with peaks up to 40 °C						
			open at 100 % I_u/I_{th}						
			enclosed at 100 % I_{the}						

[< back to table of contents >](#)

¹Valid for lines with grounded common neutral termination, overvoltage category III, pollution degree 3. Values for other supply systems on request. ²International Standards and Approvals, refer to page 35. ³Valid only for max. 4 simultaneously opening contacts. ⁴Valid for CG4 only. ⁵For electromagnetic optional extras see additional data in Catalog 101. ⁶Values for switches with spring return on request. ⁷Storage temperature: -40 °C to 85 °C (in case of temperature below -5 °C no shock load permissible).

Technical Data

CG, CH, CHR Switches

Selection Data	CG4	CG6	CH6	CHR6	CH16	CHR16
	CG4-1	CG8	CH10 CH10B	CHR10 CHR10B	CH16B	CHR16 CHR16B

[< back to table of contents >](#)

Rated Utilization Category		IEC 60947-3, EN 60947-3 VDE 0660 part 107								
AC-2	Slip ring motor starting, reversing and plugging, star-delta starting (CG4-CHR10B)	3 phase	220 V-240 V	kW	2,5	4	4	4	5,5	5,5
		3 pole	380 V-440 V		4,5	7,5	7,5	7,5	11	11
			500 V		–	10	10	10	15	15
			660 V-690 V		–	10	10	10	13	13
AC-3	Direct-on-line starting, star-delta starting (CH16-CHR16B)	3 phase	220 V-240 V	kW	1,5	3	3	3	4	4
		3 pole	380 V-440 V		2,2	5,5	5,5	5,5	7,5	7,5
			500 V		–	5,5	5,5	5,5	7,5	7,5
			660 V-690 V		–	5,5	5,5	5,5	7,5	7,5
		1 phase	110 V-120 V	kW	0,3	0,6	0,6	0,6	1,5	1,5
	2 pole	220 V-240 V	0,55		2,2	2,2	2,2	3	3	
		380 V-440 V	0,75		3	3	3	3,7	3,7	
		500 V	–		–	3	3	4	4	
		660 V-690 V	–	–	3	3	3,7	3,7		
AC-4	Direct-on-line starting, reversing, plugging and inching	3 phase	220 V-240 V	kW	0,37	0,55	0,55	0,55	1,5	1,5
		3 pole	380 V-440 V		0,55	1,5	1,5	1,5	3	3
			500 V		–	1,5	1,5	1,5	3	3
			660 V-690 V	–	1,5	1,5	1,5	3	3	
		1 phase	110 V-120 V	kW	0,15	0,3	0,3	0,3	0,45	0,45
	2 pole	220 V-240 V	0,25		0,75	0,75	0,75	1,1	1,1	
	380 V-440 V	0,5	1,5		1,5	1,5	2,2	2,2		
AC-23A	Frequent switching of motors or other high inductive loads	3 phase	220 V-240 V	kW	1,8	3,7	3,7	3,7	5,5	5,5
		3 pole	380 V-440 V		3	7,5	7,5	7,5	11	11
			500 V		–	7,5	7,5	7,5	11	11
			660 V-690 V	–	7,5	7,5	7,5	11	11	
		1 phase	110 V-120 V	kW	0,37	0,75	0,75	0,75	1,5	1,5
	2 pole	220 V-240 V	0,75		2,5	2,5	2,5	3	3	
	380 V-440 V	1,1	3,7		3,7	3,7	5,5	5,5		
		500 V	–	–	4	4	4	5,5	5,5	
		660 V-690 V	–	–	4	4	4	5,5	5,5	
Ratings	Standard motor load DOL-Rating (similar AC-3)	3 phase	110 V-120 V	HP	0,75	1,5	1,5	1,5	2	2
		3 pole	220 V-240 V		1	1	3	3	5	5
			440 V-600 V		–	–	5	5	10	10
		1 phase	110 V-120 V		0,33	0,5	0,5	0,5	1	1
		2 pole	220 V-240 V		0,75	1	1	1	2	2
			277 V		0,75	1	2	2	3	3
			440 V-600 V	–	–	2	2	5	5	
	Heavy motor load Reversing-Rating (similar AC-4)	3 phase	110 V-120 V	HP	–	0,5	0,5	0,5	1	1
		3 pole	220 V-240 V		–	1	1	1	2	2
			440 V-600 V		–	–	3	3	5	5
		1 phase	110 V-120 V		–	0,17	0,17	0,17	0,33	0,33
		2 pole	220 V-240 V		–	0,5	0,5	0,5	0,75	0,75
		277 V	–		0,5	0,6	0,6	1	1	
		440 V-600 V	–	–	1,5	1,5	2	2		
Max. Permissible Wire Gage - Use copper wire only	Single-core or stranded wire	mm ²	2x1,5	2x2,5	2x4		2x4			
		AWG	2x14	2x12	2x10		2x10			
	Flexible wire (sleeving in accordance with DIN 46228) Flexible AWG wires (without sleeve)	mm ²	2x1,5(1)	2x2,5(2,5)	2x2,5(2,5)		2x2,5(2,5)			
		AWG	2x16	2x14	2x12		2x12			
	Connection with insulated ring and fork type terminals	Internal diameter	mm				≥3,6	≥3,6		
		External diameter	mm				≤8,6	≤8,6		
Connection with quick connect terminations		mm				6,3	6,3			

Technical Data

CG, CH, CHR Switches

Selection Data	CGD4-1	CH11	CHR11	CH12	CHR12
-----------------------	--------	------	-------	------	-------

Rated Insulation Voltage U_e		IEC 60947-3, EN 60947-3 ¹ VDE 0660 part 107 ¹	V	440	600	600	600	600		
		North America	V	300	300	300	300	300		
		min. voltage	V	1 ⁴	1 ⁴	1 ⁴	6	6		
Rated Impulse Withstand Voltage U_{imp}				on request						
Rated Thermal Current I_U/I_{th}		IEC 60947-3, EN 60947-3 VDE 0660 part 107	A	5	6	6	6	6		
		North America	A	5	6	6	6	6		
Rated Operational Current I_e		IEC 60947-3, EN 60947-3 VDE 0660 part 107								
AC-21A	Switching of resistive loads, including moderate overloads	North America ²	1 V/6 V	A	5/2	6/3	6/3	-/6	-/6	
			12 V/24 V	A	1,2/0,7	2/1	2/1	6/5	6/5	
			48 V/60 V	A	0,45/-	0,8/0,7	0,8/0,7	4/3,5	4/3,5	
			110 V	A	0,25	0,4	0,4	3	3	
			240 V	A	0,15	0,2	0,2	1,8	1,8	
			300 V	A	0,13	0,13	0,13	1,3	1,3	
			440 V	A	0,1	0,1	0,1	1	1	
			500 V	A	-	0,08	0,08	0,8	0,8	
				600 V	A	-	0,05	0,05	0,5	0,5
Power loss per contact at I_U			W	0,4	0,4	0,4	0,2	0,2		
Short Circuit Protection										
Max. fuse size		(glass-tube, quick)	A	5	6	6	6	6		
Rated short-time withstand current		(1s-current)	A	30	35	35	50	50		
DC Switching Capacity⁵		IEC 60947-3, EN 60947-3 VDE 0660 part 107								
DC-21B	Resistive load $T \leq 1$ ms	North America ²	1 V/6 V	A	3/1,2	4/2,5	4/2,5	-/4	-/4	
			12 V/24 V	A	0,7/0,4	1,5/0,8	1,5/0,8	3/2,2	3/2,2	
			48 V/60 V	A	0,25/0,2	0,3/0,27	0,3/0,27	1,2/1	1,2/1	
			110 V/240 V	A	0,13/0,08	0,2/0,1	0,2/0,1	0,6/0,3	0,6/0,3	
			300 V/440 V	A	0,07/0,05	0,07/0,05	0,07/0,05	0,2/0,15	0,2/0,15	
			500 V/600 V	A	-	0,03/0,02	0,03/0,02	0,1/0,1	0,1/0,1	
Max. Permissible Wire Gage - Use copper wire only										
Single-core or stranded wire			mm ²	2x1,5	2x4		2x4			
			AWG	2x14	2x10		2x10			
Flexible wire (sleeving in accordance with DIN 46228)			mm ²	2x1,5(1)	2x2,5(2,5)		2x2,5(2,5)			
Flexible AWG wires (without sleeve)			AWG	2x16	2x12		2x12			
Connection with insulated ring and fork type terminals			mm			≥3,6		≥3,6		
Internal diameter			mm			≤8,6		≤8,6		
External diameter			mm			6,3		6,3		
Connection with quick connect terminations										
Max. Ambient Temperature of Stages				-25 °C (valid only without optional extra)						
Max. Ambient Temperature of Stages^{3, 6}		open at 100 % I_U/I_{th}		55 °C during 24 hours with peaks up to 60 °C						
		enclosed at 100 % I_{the}		35 °C during 24 hours with peaks up to 40 °C						

[< back to table of contents >](#)

Tightening torque of screws

Type	Tightening torque	
------	-------------------	--

CG4	0,4 Nm	3,5 lb-in
CG4-1	0,4 Nm	3,5 lb-in
CGD4-1	0,4 Nm	3,5 lb-in
CG6	0,8 Nm	7 lb-in
CG8	0,8 Nm	7 lb-in
CG8B	0,8 Nm	7 lb-in
CG8R	0,8 Nm	7 lb-in
CG8S	0,8 Nm	7 lb-in
CG8Y	0,8 Nm	7 lb-in
CH6	1,2 Nm	10 lb-in
CH10	1,2 Nm	10 lb-in
CH10-1	1,2 Nm	10 lb-in
CH10B	1,2 Nm	10 lb-in
CH10B-1	1,2 Nm	10 lb-in
CH10L	1,2 Nm	10 lb-in
CH10R	1,2 Nm	10 lb-in
CH10S	1,2 Nm	10 lb-in
CH11	1,2 Nm	10 lb-in
CH11B	1,2 Nm	10 lb-in
CH11R	1,2 Nm	10 lb-in
CH12	1,2 Nm	10 lb-in
CH12B	1,2 Nm	10 lb-in
CH16	1,2 Nm	10 lb-in
CH16B	1,2 Nm	10 lb-in
CH16B-1	1,2 Nm	10 lb-in
CH16S	1,2 Nm	10 lb-in
CHR6	1,4 Nm	12 lb-in
CHR6-1	1,4 Nm	12 lb-in
CHR10	1,4 Nm	12 lb-in
CHR10-1	1,4 Nm	12 lb-in
CHR10B	1,4 Nm	12 lb-in
CHR10L	1,4 Nm	12 lb-in
CHR10M	1,4 Nm	12 lb-in
CHR10R	1,4 Nm	12 lb-in
CHR10S	1,4 Nm	12 lb-in
CHR11	1,4 Nm	12 lb-in
CHR11R	1,4 Nm	12 lb-in
CHR12	1,4 Nm	12 lb-in
CHR16	1,4 Nm	12 lb-in
CHR16B	1,4 Nm	12 lb-in
CHR16L	1,4 Nm	12 lb-in
CHR16S	1,4 Nm	12 lb-in

[< back to table of contents >](#)

Dimensions mm
inch

Two or Four Hole Panel Mounting

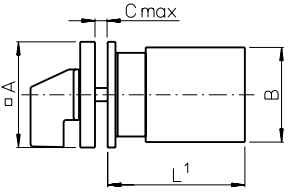

E
for
CG4-CGD4-1
CH6/CHR6
E-V
for
CG6

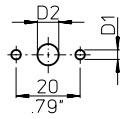

E
E-V

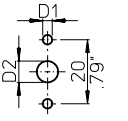

E-V
for
CG4-CGD4-1
CH6/CHR6
E
for
CG6

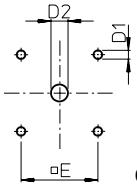

	CG4 CG4-1 CGD4-1	CG6	CG8	CH6 CHR6	CH10- CHR16	CH10B- CHR16B
A	30 1.18	30 1.18	48 1.89	30 1.18	48 1.89	64 2.52
B	28 1.10	38 1.50	38 1.50	46 1.81	46 1.81	56 2.20
C	4 .16	4 .16	4 .16	4 .16	4 .16	4 .16
D1	3,2 .13	3,2 .13	5 .20	3,2 .13	5 .20	5 .20
D2	8-11 .31-.43	8-11 .31-.43	8-19 .31-.75	8-19 .31-.75	8-19 .31-.75	10-22 .39-.87
E	-	-	36 1.42	-	36 1.42	48 1.89

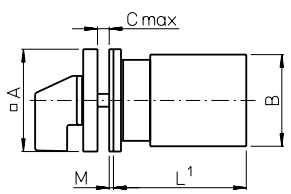

EF
for
CG4-CGD4-1
CH6/CHR6
EF-V
for
CG6

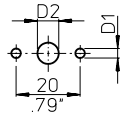

EF
EF-V

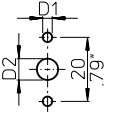

EF-V
for
CG4-CGD4-1
CH6/CHR6
EF
for
CG6

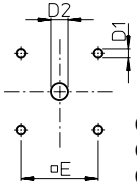

	CG4 CG4-1 CGD4-1	CG6	CG8	CH6 CHR6	CH10- CHR16	CH10B- CHR16B
A	30 1.18	30 1.18	48 1.89	30 1.18	48 1.89	64 2.52
B	28 1.10	38 1.50	38 1.50	46 1.81	46 1.81	56 2.20
C	4 .16	4 .16	4 .16	4 .16	4 .16	4 .16
D1	3,2 .13	3,2 .13	5 .20	3,2 .13	5 .20	5 .20
D2	8-11 .31-.43	8-11 .31-.43	15-19 .59-.75	8-11 .31-.43	15-19 .59-.75	19-22 .75-.87
E	-	-	36 1.42	-	36 1.42	48 1.89
M	1 .04	1 .04	-	1 .04	-	-

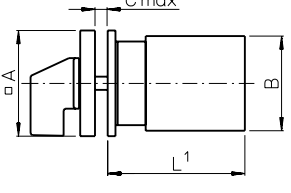

E22
for
CG
E22-V
for
CH/CHR

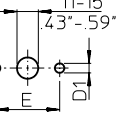

E22-V
for
CG
E22
for
CH/CHR



	CG8	CH10- CHR16
A	48 1.89	48 1.89
B	38 1.50	46 1.81
C	4 .16	4 .16
D1	5 .20	5 .20
E	30 1.17	30 1.17

¹see page 46

Dimensions mm
inch

Four Hole Panel Mounting or Mosaic Mounting

**EG
EGF**

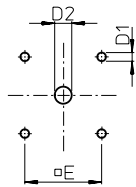
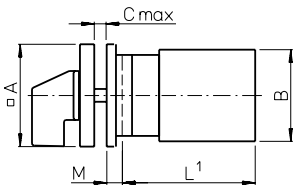

	CG8	CH10-CHR16
A	64 2.52	64 2.52
B	38 1.50	46 1.81
C	4 .16	4 .16
D1	5 .20	5 .20
EG D2	10-22 .39-.87	10-22 .39-.87
EGF D2	19-22 .75-.87	19-22 .75-.87
E	48 1.89	48 1.89
M	6,7 .26	6,7 .26

**E9
E91**

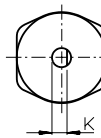
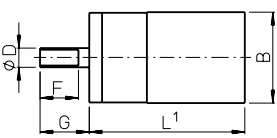

for
CG4-CGD4-1
CH6/CHR6

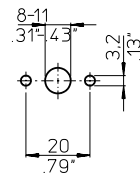

for
CG6

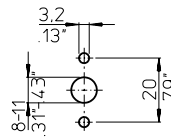

< back to table of contents >

E92

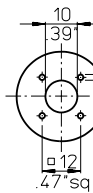
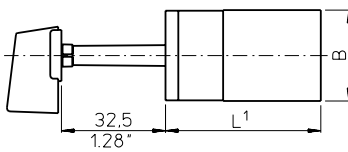

CG4
CG4-1
CGD4-1 CG6 CH6
CHR6

B	28 1.10	38 1.50	46 1.81
----------	------------	------------	------------

**E93
E94**

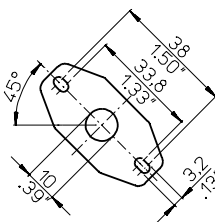
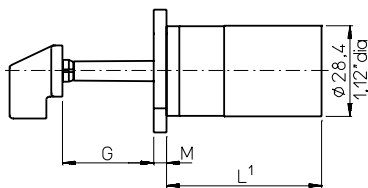

CG4
CG4-1
CGD4-1
CG6
CH6
CHR6

	E9	E91	E92	E93	E94
D	6 .24	6,35 .25	-	-	-
F	12 .47	12,8 .50	-	-	-
G	15,4 .61	17,4 .69	32,5 1.28	28,5 1.12	32,5 1.28
K	4,7 .19	5,5 .22	-	-	-
M	-	-	-	4 .16	-

¹see page 46

Dimensions mm
inch

Two or Four Hole Panel Mounting

		CH10- CG8	CH10- CHR16	CH10B- CHR16B
		ED22	EC ED	ED22
			EC ED	EC1 ED1
A		48	64	48
		1.89	2.52	1.89
B		74	68	74
		2.91	2.68	2.91
C	EC/EC1	-	4	-
	ED/ED1/ED22	-	.16	-
D1	EC/EC1	4	4	4
	ED/ED1/ED22	.16	.16	.16
D2	EC/EC1	5	5	5
	ED/ED1/ED22	.20	.20	.20
E	EC/EC1	-	10-19	-
	ED/ED1/ED22	-	.39-.75	-
F	EC/EC1	11-15	19-22	11-15
	ED/ED1/ED22	.43-.59	.75-.87	.43-.59
M	EC/EC1	-	48	-
	ED/ED1/ED22	-	1.89	-
Fluchten L	1	30	30	30
	2	1.17	1.17	1.17
1	EC/EC1	1.5	1.5	1.5
	ED/ED1/ED22	.06	.06	.06
2	EC/EC1	74,3	74,3	72,7
	ED/ED1/ED22	2,93	2,93	2,86
3	EC/EC1	74,3	74,3	72,7
	ED/ED1/ED22	2,93	2,93	2,86
4	EC/EC1	94,3	94,3	92,7
	ED/ED1/ED22	3,71	3,71	3,65
5	EC/EC1	94,3	104	94,3
	ED/ED1/ED22	3,71	4,10	3,71
6	EC/EC1	94,3	-	127
	ED/ED1/ED22	3,71	-	5,00
7	EC/EC1	-	-	139,5
	ED/ED1/ED22	-	-	5,49
8	EC/EC1	-	-	164,5
	ED/ED1/ED22	-	-	6,48
9	EC/EC1	-	-	177
	ED/ED1/ED22	-	-	6,97
10	EC/EC1	-	-	-
	ED/ED1/ED22	-	-	-

< back to table of contents >

Dimensions mm
inch

Four Hole Panel Mounting or Single Hole Mounting

**KN1
KD1
KN2**

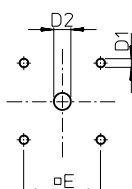
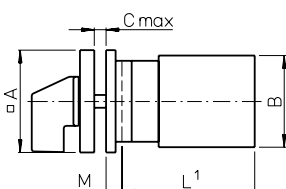

	KN2	
	CG8	CH10-CHR16
A	48 1.89	48 1.89
B	38 1.50	46 1.81
C	4 .16	4 .16
D1	5 .20	5 .20
D2	8-19 .31-.75	8-19 .31-.75
E	36 1.42	36 1.42
M	5.2 .20	5.2 .20

	KN1		
	KD1 CG8	CH10-CHR16	CH10B-CHR16B
A	64 2.52	64 2.52	64 2.52
B	38 1.50	46 1.81	56 2.20
C	4 .16	4 .16	4 .16
D1	5 .20	5 .20	5 .20
D2	10-22 .39-.87	10-22 .39-.87	10-22 .39-.87
E	48 1.89	48 1.89	48 1.89
M	4.7 .19	4.7 .19	7 .28

< back to table of contents >

**FS1...
FT1...
FT3...**

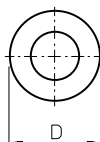

**FH3...
FS2...
FT2...
FT4...**

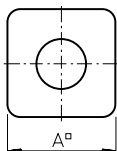

**FH4...
FS4...
FT6...**

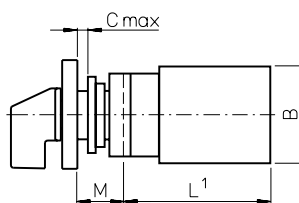
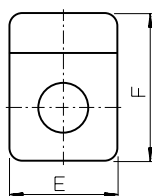

**FS1...
FS2...
FS4...**

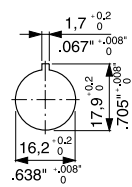

**FH3...
FH4...
FT1...
FT2...
FT6...**

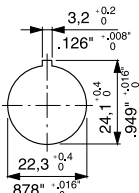

**FT3...
FT4...**

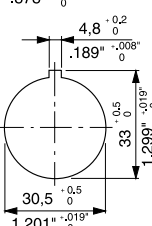
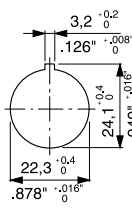
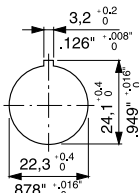

	CG4		CG8	CH6 CHR6	CH10- CHR16
	CG4-1 CGD4-1	CG6			
A/E	30 1.18	30 1.18	48 1.89	30 1.18	48 1.89
FH3...	-	-	64 2.52	-	64 2.52
FH4...	-	-	64 2.52	-	64 2.52
B	28 1.10	38 1.50	38 1.50	46 1.81	46 1.81
C	5 .20	5 .20	6 .24	5 .20	6 .24
D	29.5 1.16	29.5 1.16	39.4 1.55	29.5 1.16	39.4 1.55
F	39 1.54	39 1.54	59 2.32	39 1.54	59 2.32
FH4...	-	-	78.5 3.09	-	78.5 3.09
M	12.5 .49	12.5 .49	18.2 .72	12.5 .49	18.2 .72
FH3...	-	-	25.2 .99	-	25.2 .99
FH4...	-	-	25.2 .99	-	25.2 .99

¹see page 46

Dimensions mm
inch

Base Mounting

**VE
VE-V**

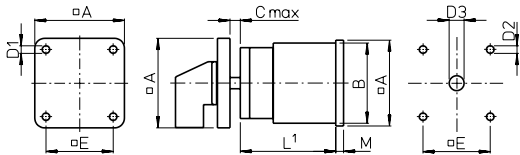

**VF
VF-V**

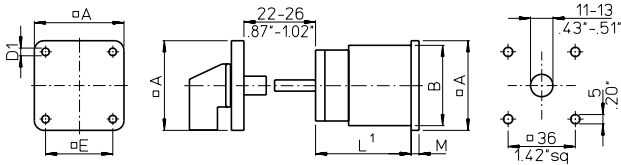

**VE22
VE22V**

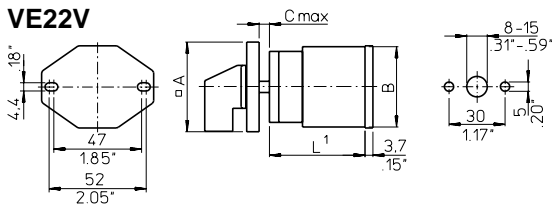

**VF22
VF22V**

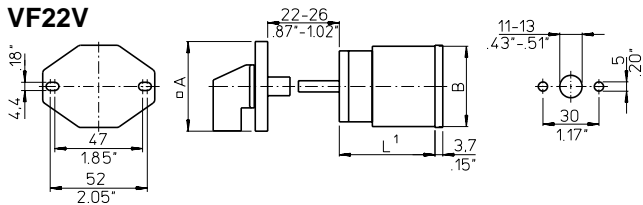

	CG8	CH10-CHR16
A²	48 1.89	48 (64) 1.89 (2.52)
B	38 1.50	46 1.81
C	10,5 .41	10,5 .41
D1	4,1 .16	4,1 .16
D2	5 .20	5 .20
D3	8-15 .31-.59	8-15 .31-.59
E²	36 1.42	36 (48) 1.42 (1.89)
M	2,2 .09	5,2 .20

²Dimensions in () for revertive mounting plate

VE1

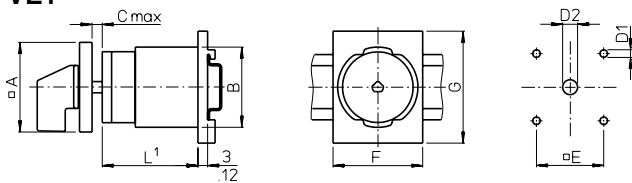

VE1E

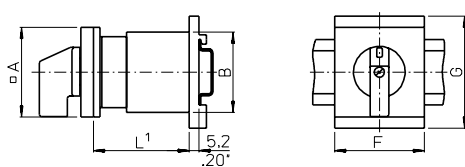

VE1F

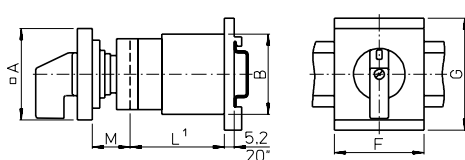

	CG4 CG4-1 CGD4-1	CG8	CH10-CHR16
A	30 1.18	48 1.89	48 1.89
B	28 1.10	38 1.50	46 1.81
C	-	10,5 .41	10,5 .41
D1	-	5 .20	5 .20
D2	-	8-15 .31-.59	8-15 .31-.59
E	-	36 1.42	36 1.42
F	35,5 1.40	48 1.89	48 1.89
G	60 2.36	60 2.36	60 2.36
M	12,5 .49	20 .79	20 .79

¹see page 46

Dimensions mm
inch

Base Mounting and Escutcheon Plates

VE2

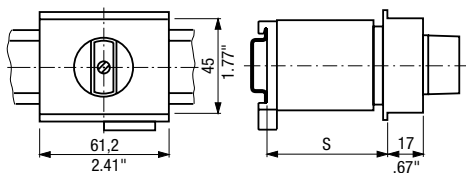

VE21

for CG4-CGD4-1

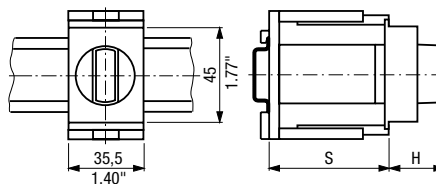

VE3

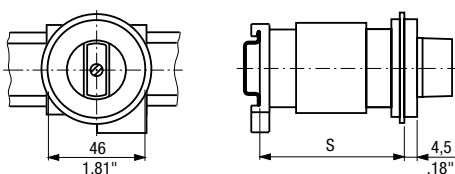

VE21

for CG8-CHR16

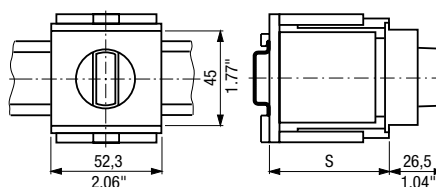

VE4

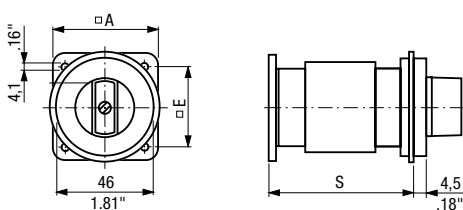

< back to table of contents >

	VE2		VE3		VE4	
	CG8	CH10-CHR16	CG8	CH10-CHR16	CG8	CH10-CHR16
	Max. no. of stages		Max. no. of stages		Max. no. of stages	
S = 46 1.81	1	1	-	-	1	-
S = 50 1.97	2	2	1	1	1	-
S = 61 2.40	3	-	2	1	2	1
S = 67 2.64	-	3	2	2	2	2
S = 69 2.70	-	-	2	2	2	2
A					48 1.89	64 2.52
E					36 1.42	48 1.89

VE21		CG4-CGD4-1	CG8	CH10-CHR16
S_{min.}	H			
44 1.73	21 .83	1	1	1
46 1.81	26,5 1.04	2	2	-
50 1.97	-	-	-	2
54 2.13	-	-	-	-
60 2.36	-	-	3	-
62 2.44	26,5 1.04	3	-	-
64 2.52	-	-	-	3
72 2.83	-	-	4	-

Escutcheon plates for mounting E, EF, EG, EGF, KN1, KD1, KN2, EC, EC1, ED, ED1, VE, VE1, VF

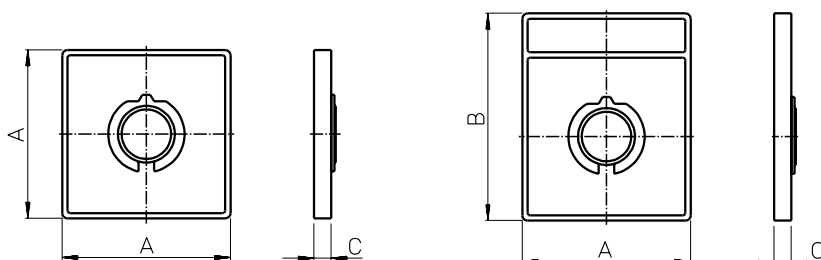

Size	A	B	C
S00	30 1.18	39 1.54	5,5 .22
S0	48 1.89	59 2.32	6,7 .26
S1	64 2.52	78 3.07	7,4 .29

Dimensions mm
inch

Additional Lengths

Additional lengths for amendment (page 6)

	CG8	CH10 CH16	CHR10 CHR16
B	6,2 .24	6,2 .24	6,2 .24
S	17,3 .68	17,3 .68	17,3 .68
L, M	24,8 .98	24,8 .98	24,8 .98
X	23,3 .92	23,3 .92	23,3 .92

Quick connect terminations (plug 2,8 mm or 6,35 mm) for CH switches (page 6)

with quick connects

with angled quick connects

Length L

Stages	CG4		CG8	CH6 CHR6	CH10	CHR10	CH10B CH16B	CHR10B CHR16B
	CG4-1 CGD4-1	CG6			CH11 CH12 CH16	CHR11 CHR12 CHR16		
1	38,5	43,2	40,7	46	43,5	43,5	48,9	48,9
	1.52	1.70	1.60	1.81	1.71	1.71	1.93	1.93
2	50,5	55,9	53,4	60	57,5	57,5	62,9	62,9
	1.99	2.20	2.10	2.36	2.26	2.26	2.48	2.48
3	62,5	68,6	66,1	74	71,5	71,5	76,9	76,9
	2.46	2.70	2.60	2.91	2.81	2.81	3.03	3.03
4	74,5	81,3	78,8	88	85,5	85,5	90,9	90,9
	2.93	3.20	3.10	3.46	3.37	3.37	3.58	3.58
5	86,5	-	91,5	-	99,5	99,5	104,9	104,9
	3.41	-	3.60	-	3.92	3.92	4.13	4.13
6	98,5	-	104,2	-	113,5	113,5	118,9	118,9
	3.88	-	4.10	-	4.47	4.47	4.68	4.68
7	110,5	-	116,9	-	127,5	127,5	132,9	132,9
	4.35	-	4.60	-	5.02	5.02	5.23	5.23
8	122,5	-	129,6	-	141,5	141,5	146,9	146,9
	4.82	-	5.10	-	5.57	5.57	5.78	5.78
9	-	-	142,3	-	155,5	155,5	160,9	160,9
	-	-	5.60	-	6.12	6.12	6.34	6.34
10	-	-	155	-	169,5	169,5	174,9	174,9
	-	-	6.10	-	6.67	6.67	6.89	6.89
11	-	-	167,7	-	183,5	183,5	188,9	188,9
	-	-	6.60	-	7.22	7.22	7.44	7.44
12	-	-	180,4	-	197,5	197,5	202,9	202,9
	-	-	7.10	-	7.77	7.77	7.99	7.99

< back to table of contents >

Notes:

[< back to table of contents >](#)

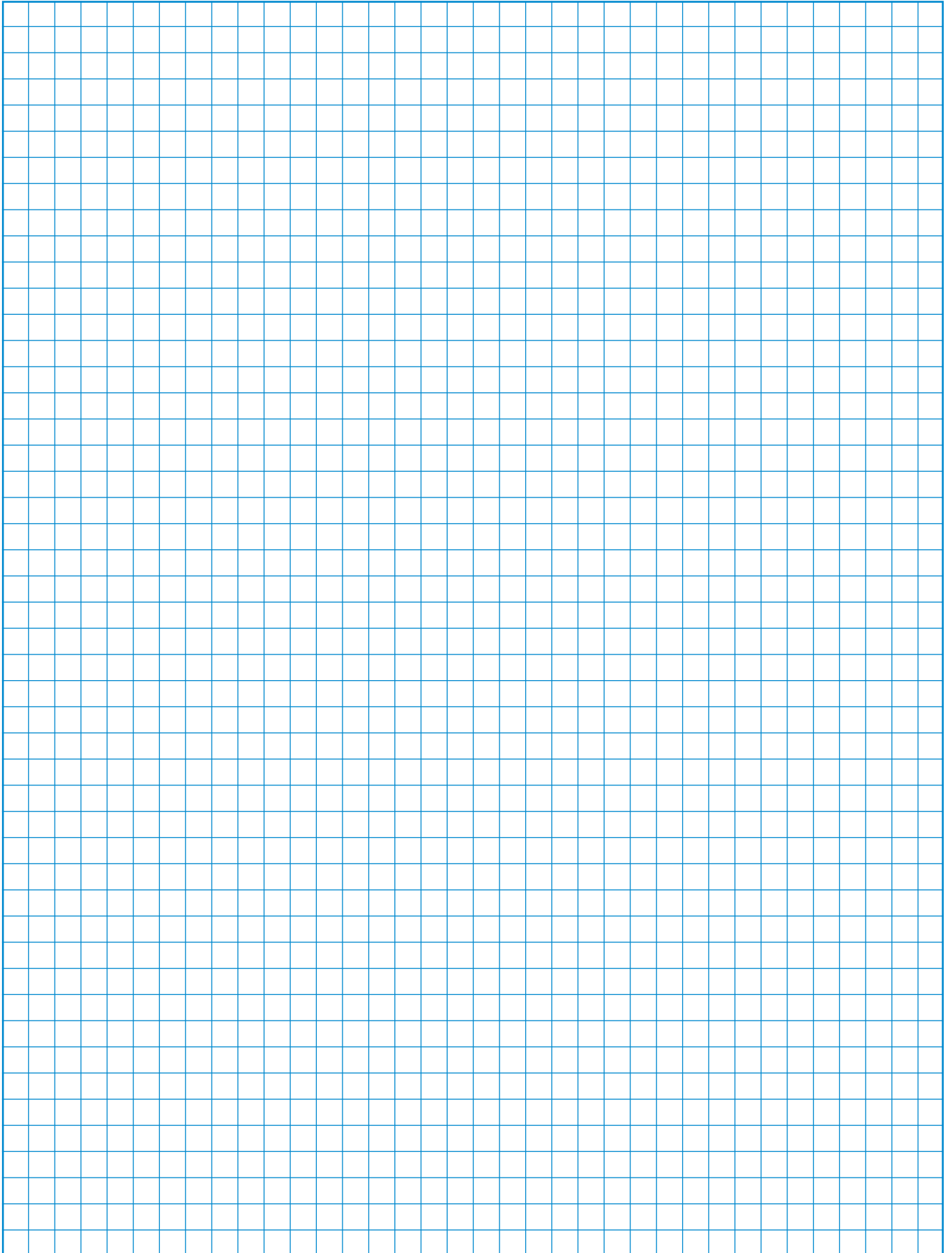

The Range of “Blue Line” Switchgear

Technical literature covering the following products is available on request.

	Catalog Number
<p>Main Switches and Main Switches with Emergency Function 16 A-315 A Maintenance Switches 20 A-315 A Switch Disconnectors 20 A-315 A According to IEC 60947-3, EN 60947-3, VDE 0660 part 107, IEC 60204, EN 60204 and VDE 0113</p>	500
<p>CL Switches 10 A-20 A C, CA and CAD Switches 10 A-315 A and L Switches 350 A-2400 A C, CA and CAD switches are designed for universal application. They are recommended for instrument, isolator, double-throw and motor control. L switches are designed for load and off-load applications. They are used to switch resistive or low inductive loads.</p>	100
<p>Optional Extras and Enclosures The complete product line, a large number of optional extras is available, including door interlocks, push-pull devices, cylinder and padlock attachments, control and indicator devices, AC motor drives, as well as enclosures, both insulated and metal.</p>	101
<p>A and AD Switches 6 A-25 A A and AD switches have 4 contacts in each switching stage. These switches provide an extensive range of switch functions and require a minimum mounting depth. Up to 24 switching positions are possible, with availability of 48 contacts per 12 stage switch column.</p>	110
<p>CG, CH and CHR Switches 10 A-25 A Ultra compact CG, CH and CHR switches are ideally suited for control and instrumentation applications. Switch terminals are “finger-proof” and conveniently accessible for wiring and are delivered open. All CG4 switches offer specially designed gold plated contacts or H-bridges with “cross-wire” contact systems, which facilitates their use in electronic circuitry and chemically aggressive environments.</p>	120
<p>DH, DHR, DK and DKR Switches 6 A-16 A DH, DHR, DK and DKR switches incorporate unique corrosion resistant contacts that permit operation on system voltage as low as 1 V. They have fully enclosed and protected contacts which can be operated either by rotary and/or lateral handle movement. D switches are used in calibration and semiconductor circuits. They are also used for relay and contactor control.</p>	130
<p>X Switches 200 A-630 A X switches can be applied for load, tap and gang switching duties. They incorporate 6 contacts in each switching stage. Their compact design provides a minimum length dimension for mounting purposes.</p>	140
<p>KG Switches 20 A-315 A and KH and KHR Switches 16 A-80 A KG, KH and KHR switches are excellent circuit interruptors. They have high through fault and fault making capacities and are especially designed for use as isolators and safety switches for machine tools, distribution panels and switchboards. KG ON/OFF switches offer unusually high dimensioned air and creepage distances between terminals which are designed for time saving “straight-line” wiring. ON/OFF switches are available with up to 8 poles and double-throw switches are available with up to 4 poles.</p>	150
<p>Push Buttons and Pilot Lights, 22,5 mm Ø A complete range of state-of-the-art push buttons and pilot lights represent an ideal combination of functional security and economical efficiency in a modular design.</p>	302

We reserve the right to make technical and dimensional changes without prior notice.

SALES AND SERVICE ORGANIZATION

Australia

Kraus & Naimer Pty. Ltd.
379 Liverpool Road, ASHFIELD, N.S.W. 2131
P: 1800 567 948
E: sales-au@krausnaimer.com

Austria

Kraus & Naimer GmbH
Schumannngasse 39
1180 WIEN
P: +43 1 404 06 0
E: sales-at@krausnaimer.com

Belgium, Luxembourg

Kraus & Naimer B.V.
Ikaros Business Park
Ikaroslaan 2
1930 ZAVENTHEM
P: +32 2 757 0141
F: +32 2 757 1640
E: sales-be@krausnaimer.com

Brazil

Central and South America
Kraus & Naimer Ind. Com. Ltda.
Rua Santa Monica, 1061
Parque Industrial San Jose
P: +55 11 2198 1288
F: +55 11 2198 1251
E: knbrasil@krausnaimer.com.br

Canada

Kraus & Naimer Ltd.
219 Connie Crescent, Unit 13A
CONCORD, Ontario, L4K 1L4
P: +1 905 738 1666
E: sales-ca@krausnaimer.com

Cyprus

ELECTROMATIC CONSTRUCTIONS LTD.
72, Evagoras Pallikarides Str., 2235 LATSIA-Nicosia
P. O. Box 12630, 2251 LATSIA-Nicosia
P: +357 2 48 41 41
F: +357 2 48 57 47
E: electromatic@cytanet.com.cy

Czech Republic

OBZOR, výrobní družstvo Zlín
Na Slanici 378
763 02 ZLÍN
P: +420 577 195 150
F: +420 577 195 152
E: odbyt@obzor.cz

Denmark

THIIM A/S
Transformervej 31
2860 SOEBORG
P: +45 4485 8000
F: +45 4485 8005
E: thiim@thiim.com

Finland

Kraus & Naimer Oy
Kiitoradankuja 8
01530 VANTAA
P: +358 9 825 424 0
E: sales-fi@krausnaimer.com

France

Kraus & Naimer s.a.s.
33, rue Bobillot
75013 PARIS
P: +33 1 58 40 80 80
E: sales-fr@krausnaimer.com

Germany

Kraus & Naimer GmbH
Wikingerstraße 20-28, 76189 KARLSRUHE
Postfach 10 01 24, 76231 KARLSRUHE
P: +49 721 59 88 0
E: sales-de@krausnaimer.com

Great Britain

Kraus & Naimer Ltd.
115 London Road
NEWBURY/BERKSHIRE RG14 2AH
P: +44 1635 262626
F: +44 1635 37807
E: sales-uk@krausnaimer.com

Greece

KALAMARAKIS-SAPOUNAS S. A.
Ionias & Neromilou Str., P. O. Box 46566
13671 ACHARNES/ATHENS
P: +30 2 10 240 6000 6
F: +30 2 10 240 6007
E: kalamarakis.sapounas@ksa.gr

Hungary

GANZ KK KFT.
X. Kőbányai út 41/c, Postfach 87
1475 BUDAPEST
P: +36 1 261 5479
E: ganzkk@ganzkk.hu

Iceland

JOHAN RÖNNING LTD.
Klettgarðar 25
104 REYKJAVIK
P: +354 5200 800
E: ronning@ronning.is

Republic of Ireland

Kraus & Naimer Ltd.
4235 Atlantic Avenue
Westpark Business Campus
Shannon, Co. Clare
P: +353 61 704700
F: +353 61 471084
E: sales-ie@krausnaimer.com

Italy

Kraus & Naimer s.r.l.
Via Terracini, 9
24047 TREVIGLIO (BG)
P: +39 0363 30 11 12
E: sales-it@krausnaimer.com

Japan

Kraus & Naimer Ltd.
Yoshiwada Building 2F
1-11-6 Hamamatsucho
Minato-Ku, TOKYO 105-0013
P: +81 3 3436 6151
F: +81 3 3436 6325
E: sales-jp@krausnaimer.com

Mexico

JC INGENIERÍA Y CONTROL, SA DE CV.
Ángel Gavilño 30.
C. Satélite, C. Medicos,
Naucalpan Edo. de Mexico, C.P. 53100
P: +52 55 55 62 75 77
F: +52 55 55 62 04 34
E: ventas@jcingenieriacontrol.com

Netherlands

Kraus & Naimer B.V.
Wegtersweg 38-40, Postbus 199
7556 BR HENGEL0 (Ov.)
P: +31 74 291 9441
F: +31 74 291 98380
E: sales-nl@krausnaimer.com

New Zealand

Kraus & Naimer Ltd.
42 Miramar Avenue, WELLINGTON 6022
P. O. Box 15-009, WELLINGTON 6243
P: + 64 0800 736 522
E: sales-nz@krausnaimer.com

Norway

Kraus & Naimer AB Avd. Norge
Postboks 27 Vollebakk
0516 Oslo
P: +47 22 64 44 20
E: sales-no@krausnaimer.com

Poland

ASTAT LOGISTYKA SP. Z O.O.
Dąbrowskiego 441
60451 POZNAŃ
P: +48 61 849 80 89
E: k.swiderski@astat.pl

Portugal

ELECTRICOL-DAMAS, FERREIRA & DAMASCENO, LDA.
Apartado 1063, S. Ant. Cavaleiros
2670 LOURES
P: +351 21 989 8939
F: +351 21 988 6464
E: electrical@electricol.pt

Singapore, India, Middle East – UAE

Kraus & Naimer Pte. Ltd.
115A, Commonwealth Drive
#03-17/23
SINGAPORE 149 596
P: +65 6473 8166
E: sales-sg@krausnaimer.com

Slovenia

SCHRACK TECHNIK D.O.O.
Pameče 175
SI-2380 SLOVENJ GRADEC
P: +386 2 88 392 00
F: +386 2 88 434 71
E: d.goljat@schrack.si

Republic of South Africa

Kraus & Naimer Pty. Ltd.
7 Village Crescent, Linbro Village
Linbro Business Park, SANDTON 2065
P. O. Box 511, KELVIN 2054
P: +27 11 608 6060
E: sales-za@krausnaimer.com

Spain

Kraus & Naimer B.V.
P: +34 662 696 014
E: sales-es@krausnaimer.com

Sweden

Kraus & Naimer AB
Dr. Widerströms Gata 11, Hägersten
Box 42097, 126 14 STOCKHOLM
P: +46 8 97 00 80
E: sales-se@krausnaimer.com

Switzerland

AWAG Elektrotechnik AG
Sandbühlstraße 2
CH-8604 VOLKETSCHWIL
P: +41 44 908 19 19
E: info@awag.ch

Turkey

KARDES ELEKTRİK SANAYİ VE TİCARET A.Ş.
Yassıoren Mah. Hıfı Sok. No: 4
34277 Arnavutköy-Istanbul-Turkey
P: +90 212 624 92 04 118
F: +90 212 592 48 10
E: info@unalkardes.com.tr

USA

Kraus & Naimer Inc.
760 New Brunswick Road
SOMERSET, NJ 08873
P: +1 732 560 1240
E: sales-us@krausnaimer.com



Kraus & Naimer



Contact us:

www.krausnaimer.com



**SCATTERGOOD
& JOHNSON LTD**
ELECTRICAL ENGINEERING & FLUID CONTROL DISTRIBUTORS

Est.1899

At Scattergood & Johnson Ltd, we pride ourselves on being a technical distributor to specialist industries.

Working with a range of quality product manufacturers across a number of specialist markets, we are not your average 'box shifter' - we are your technical and supply chain partner.

We fully support every product we sell - for free! Our internal team and external sales engineers can answer any product or application question, no matter the complexity.

Backing up this technical ability is a range of 50,000+ products available from stock for nationwide next day delivery (same day if required!), or you can collect what you need from any of our trade counters around the UK.

Select your specialist interest below to learn more about how we can help.

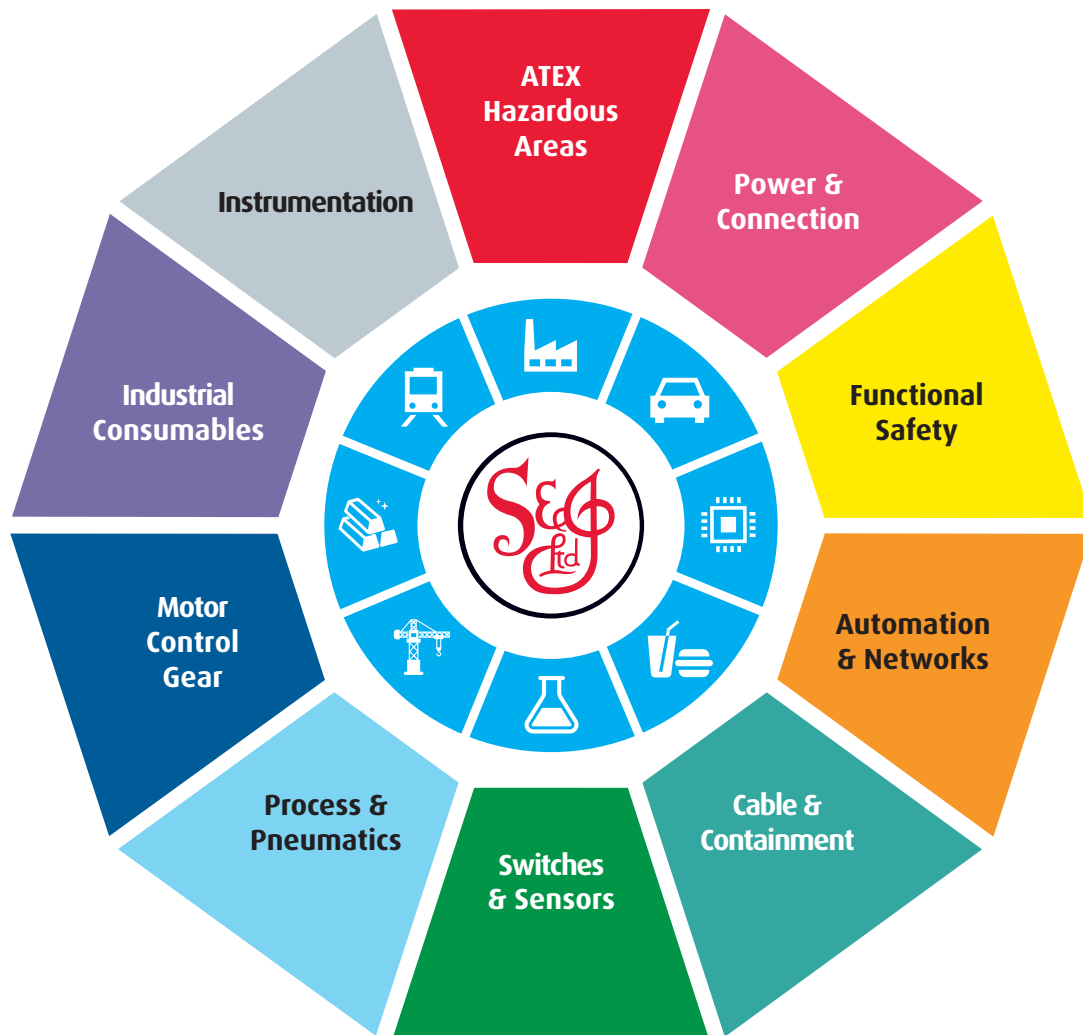

Online, In Branch and On the Road - Scattergood & Johnson Ltd, there when you need us.

www.scatts.co.uk