

Technical Data Sheet

Classic Hand Operated Rotary Switches

CDPD182
Issue 1

General Description

Hand operated rotary switches provide the most cost effective method of providing complex contact switching functions. However, every item of electrical equipment needs a method of disconnecting it safely from the supply, and here again, the rotary switch with positive break contacts, performs that function effectively.

In this data sheet we show the basic building blocks only; so if you need a standard format it's here, but please be aware that a special version is only a phone call away.



R6/R16 The R6 & R16 rotary switches are built upon a common frame, the R16 deriving themselves to the more common rotary switch functions such as 'isolation' and they are also ideal for the specialist OEM user.

Mini-rotary The mini-rotary switch is one of the most versatile items in the rotary switch families. Its design permits the addition of a wide range of accessories. The switch is well proven in arduous conditions, being particularly favoured for Rail applications with its ability to withstand the required 'shock & vibration' tests.

R40 Control panel manufacturers favour the mini-rotary switch for its rear facing terminals which can be useful in terminating in confined spaces. The R40 rotary switch represents the ultimate in versatility. To this frame size we have added the facility of both 30° & 60° indexing. With excellent switching performance and a high level of mechanical strength, the R40 is the choice for isolation duties.

Technical Specification

Data supplied against tests to IEC/BS EN 60947-3

Application	Sym	Unit		R6	R16	Mini-Rotary	R40
Image							
Thermal rating	I_{th}	A		6	16	20	40
Position indexing options				90° & 45°	90° & 45°	90° & 45°	90°, 60°, 45° & 30°
Standard operating knob				Included	Included	Included	Included
Rated voltage	U_i	V		690	690	690	690
Switching characteristics			AC20A	6A @ 250V & 415V	16A @ 250V & 415V	20A @ 250V & 415V	40A @ 250/415/660/690V
			AC21A	6A @ 250V & 415V	16A @ 250V & 415V	20A @ 250V & 415V	32A @ 250V & 415V
			AC22A	6A @ 250V & 415V	16A @ 250V & 415V	20A @ 250V & 415V	32A @ 250V & 415V
			AC23A	6A/0.75kW @ 250V 6A/2.5kW @ 415V	16A/2.5kW @ 250V 16A/5.5kW @ 415V	20A/3.0kW @ 250V 20A/9.5kW @ 415V	28A/3.75kW @ 250V 28A/15.0kW @ 415V
Rated short time withstand		A	1 sec	120	240	434	800
Maximum BS 88 backup fuse		A		6	20	32	40
Finger protected terminals				IP2X	IP2X	--	IP2X
Contact material				Ag/Ni	Ag/Ni	Fine Silver	Ag/CdO
Mechanical life				>0.5 x 10 ⁶	>0.5 x 10 ⁶	>0.5 x 10 ⁶	>0.5 x 10 ⁶
Termination size				M3.5	M3.5	M4	M5
Maximum connecting cable size		mm ²		4.0	4.0	2 x 4.0	6.0
Standard shaft size		mm	(sq)	5.5	5.5	4.8	5.5

Technical Data Sheet

Classic Hand Operated Rotary Switches

CDPD182
Issue 1

Classic Rotary Switches - Changeover

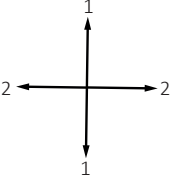
Unrestricted- 90° Four Position Stayput- 1/2/1/2				
Posn. Diag	Rating	Poles	'L'	Cat. No
 <p>Options for this sequence:- MBB- Make before break contacts (Add suffix /MBB e.g. MT42/MBB) NC- Electrically separate contacts. (Add suffix /NC e.g. R16Q42/NC)</p>	6A	1	42	R6S22
	6A	2	42	R6D22
	6A	3	63	R6T42
	6A	4	63	R6Q42
	6A	5	84	R6X62
	6A	6	84	R6Y62
	16A	1	42	R16S22
	16A	2	42	R16D22
	16A	3	63	R16T42
	16A	4	63	R16Q42
	16A	5	84	R16X62
	16A	6	84	R16Y62
	20A	1	41	MS22
	20A	2	41	MD22
	20A	3	62	MT42
	20A	4	62	MQ42
	20A	5	82	MX62
	20A	6	82	MY62
	40A	1	49	RS3222
	40A	2	49	RD3222
	40A	3	74	RT3242
	40A	4	74	RQ3242
	40A	5	100	RX3262
	40A	6	100	RY3262

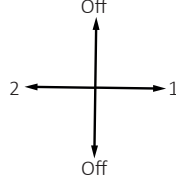
Unrestricted- 90° Four Position Stayput- Off/1/Off/2				
Posn. Diag	Rating	Poles	'L'	Cat. No
 <p>Options for this sequence:- NC- Electrically separate contacts. (Add suffix /NC e.g. RY3263/NC)</p>	6A	1	31	R6S13
	6A	2	42	R6D23
	6A	3	52	R6T33
	6A	4	63	R6Q43
	6A	5	73	R6X53
	6A	6	84	R6Y63
	16A	1	31	R16S13
	16A	2	42	R16D23
	16A	3	52	R16T33
	16A	4	63	R16Q43
	16A	5	73	R16X53
	16A	6	84	R16Y63
	20A	1	31	MS13
	20A	2	41	MD23
	20A	3	51	MT33
	20A	4	62	MQ43
	20A	5	72	MX53
	20A	6	82	MY63
	40A	1	35	RS3213
	40A	2	49	RD3223
	40A	3	62	RT3233
	40A	4	74	RQ3243
	40A	5	87	RX3253
	40A	6	100	RY3263

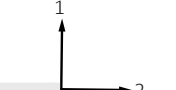
Restricted- 90° Two Position Stayput- 1/2				
Posn. Diag	Rating	Poles	'L'	Cat. No
 <p>Options for this sequence:- MBB- Make before break contacts (Add suffix /MBB e.g. MS12/1/MBB) NC- Electrically separate contacts. (Add suffix /NC e.g. R6X32/1/NC)</p>	6A	1	31	R6S12/1
	6A	2	42	R6D22/1
	6A	3	52	R6T32/1
	6A	4	63	R6Q42/1
	6A	5	73	R6X52/1
	6A	6	84	R6Y62/1
	16A	1	31	R16S12/1
	16A	2	42	R16D22/1
	16A	3	52	R16T32/1
	16A	4	63	R16Q42/1
	16A	5	73	R16X52/1
	16A	6	84	R16Y62/1
	20A	1	31	MS12/1
	20A	2	41	MD22/1
	20A	3	51	MT32/1
	20A	4	62	MQ42/1
	20A	5	72	MX52/1
	20A	6	82	MY62/1
	40A	1	35	RS3212/1
	40A	2	49	RD3222/1
	40A	3	62	RT3232/1
	40A	4	74	RQ3242/1
	40A	5	87	RX3252/1
	40A	6	100	RY3262/1

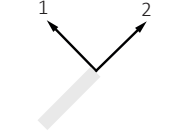
Restricted- 90°/45° Two Position Stayput- 1/2				
Posn. Diag	Rating	Poles	'L'	Cat. No
 <p>Options for this sequence:- MBB- Make before break contacts (Add suffix /MBB e.g. RT3232/2/MBB) NC- Electrically separate contacts. (Add suffix /NC e.g. MQ42/2/NC)</p>	6A	1	31	R6S12/2
	6A	2	42	R6D22/2
	6A	3	52	R6T32/2
	6A	4	63	R6Q42/2
	6A	5	73	R6X52/2
	6A	6	84	R6Y62/2
	16A	1	31	R16S12/2
	16A	2	42	R16D22/2
	16A	3	52	R16T32/2
	16A	4	63	R16Q42/2
	16A	5	73	R16X52/2
	16A	6	84	R16Y62/2
	20A	1	31	MS12/2
	20A	2	41	MD22/2
	20A	3	51	MT32/2
	20A	4	62	MQ42/2
	20A	5	72	MX52/2
	20A	6	82	MY62/2
	40A	1	35	RS3212/2
	40A	2	49	RD3222/2
	40A	3	62	RT3232/2
	40A	4	74	RQ3242/2
	40A	5	87	RX3252/2
	40A	6	100	RY3262/2

Technical Data Sheet

Classic Hand Operated Rotary Switches

CDPD182
Issue 1

Classic Rotary Switches - Changeover

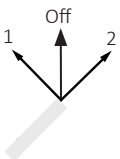
Restricted- 45° Three Position Stayput- 1/2				
Posn. Diag	Rating	Poles	'L'	Cat. No
Sequence- SEQ3/3 	6A	1	31	R6S13/3
	6A	2	42	R6D23/3
	6A	3	52	R6T33/3
	6A	4	63	R6Q43/3
	6A	5	73	R6X53/3
	6A	6	84	R6Y63/3
	16A	1	31	R16S13/3
	16A	2	42	R16D23/3
	16A	3	52	R16T33/3
	16A	4	63	R16Q43/3
	16A	5	73	R16X53/3
	16A	6	84	R16Y63/3
	20A	1	31	MS13/3
	20A	2	41	MD23/3
	20A	3	51	MT33/3
	20A	4	62	MQ43/3
	20A	5	72	MX53/3
	20A	6	82	MY63/3
	40A	1	35	RS3213/3
	40A	2	49	RD3223/3
40A	3	62	RT3233/3	
40A	4	74	RQ3243/3	
40A	5	87	RX3253/3	
40A	6	100	RY3263/3	

Options for this sequence:-
NC- Electrically separate contacts.
(Add suffix /NC e.g. MQ43/3/NC)

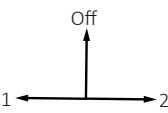
Restricted- 90° Three Position Stayput- 1/Off/2				
Posn. Diag	Rating	Poles	'L'	Cat. No
Sequence- SEQ3/4 	6A	1	31	R6S13/4
	6A	2	42	R6D23/4
	6A	3	52	R6T33/4
	6A	4	63	R6Q43/4
	6A	5	73	R6X53/4
	6A	6	84	R6Y63/4
	16A	1	31	R16S13/4
	16A	2	42	R16D23/4
	16A	3	52	R16T33/4
	16A	4	63	R16Q43/4
	16A	5	73	R16X53/4
	16A	6	84	R16Y63/4
	20A	1	31	MS13/4
	20A	2	41	MD23/4
	20A	3	51	MT33/4
	20A	4	62	MQ43/4
	20A	5	72	MX53/4
	20A	6	82	MY63/4
	40A	1	35	RS3213/4
	40A	2	49	RD3223/4
40A	3	62	RT3233/4	
40A	4	74	RQ3243/4	
40A	5	87	RX3253/4	
40A	6	100	RY3263/4	

Options for this sequence:-
NC- Electrically separate contacts.
(Add suffix /NC e.g. MQ43/4/NC)

Restricted- 45° Two Position Spring Return- 1<2				
Posn. Diag	Rating	Poles	'L'	Cat. No
Sequence- SEQ2/SR 	6A	1	31	R6S12/SR
	6A	2	42	R6D22/SR
	6A	3	52	R6T32/SR
	6A	4	63	R6Q42/SR
	6A	5	73	R6X52/SR
	6A	6	84	R6Y62/SR
	16A	1	31	R16S12/SR
	16A	2	42	R16D22/SR
	16A	3	52	R16T32/SR
	16A	4	63	R16Q42/SR
	16A	5	73	R16X52/SR
	16A	6	84	R16Y62/SR
	20A	1	31	MS12/SR
	20A	2	41	MD22/SR
	20A	3	51	MT32/SR
	20A	4	62	MQ42/SR
	20A	5	72	MX52/SR
	20A	6	82	MY62/SR
	40A	1	35	RS3212/SR
	40A	2	49	RD3222/SR
40A	3	62	RT3232/SR	
40A	4	74	RQ3242/SR	
40A	5	87	RX3252/SR	
40A	6	100	RY3262/SR	

Options for this sequence:-
NC- Electrically separate contacts.
(Add suffix /NC e.g. MQ42/SR/NC)

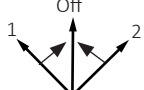
Restricted- 45° Three Position Spring Return- 1>Off<2				
Posn. Diag	Rating	Poles	'L'	Cat. No
Sequence- SEQ3/SR 	6A	1	31	R6S13/SR
	6A	2	42	R6D23/SR
	6A	3	52	R6T33/SR
	6A	4	63	R6Q43/SR
	6A	5	73	R6X53/SR
	6A	6	84	R6Y63/SR
	16A	1	31	R16S13/SR
	16A	2	42	R16D23/SR
	16A	3	52	R16T33/SR
	16A	4	63	R16Q43/SR
	16A	5	73	R16X53/SR
	16A	6	84	R16Y63/SR
	20A	1	31	MS13/SR
	20A	2	41	MD23/SR
	20A	3	51	MT33/SR
	20A	4	62	MQ43/SR
	20A	5	72	MX53/SR
	20A	6	82	MY63/SR
	40A	1	35	RS3213/SR
	40A	2	49	RD3223/SR
40A	3	62	RT3233/SR	
40A	4	74	RQ3243/SR	
40A	5	87	RX3253/SR	
40A	6	100	RY3263/SR	

Options for this sequence:-
NC- Electrically separate contacts.
(Add suffix /NC e.g. MQ42/SR/NC)

Technical Data Sheet

Classic Hand Operated Rotary Switches

CDPD182
Issue 1

Classic Rotary Switches - Changeover

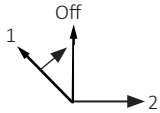
Restricted- 90° Three Position (Spring Return)- 1>Off/2					
Posn. Diag	Rating	Poles	'L'	Cat. No	
Sequence- SEQ5/SR 	6A	1	31	R6S15/SR	
	6A	2	42	R6D25/SR	
	6A	3	52	R6T35/SR	
	6A	4	63	R6Q45/SR	
	6A	5	73	R6X55/SR	
	6A	6	84	R6Y65/SR	
	16A	1	31	R16S15/SR	
	16A	2	42	R16D25/SR	
	16A	3	52	R16T35/SR	
	16A	4	63	R16Q45/SR	
	16A	5	73	R16X55/SR	
	16A	6	84	R16Y65/SR	
	Options for this sequence:- NC- Electrically separate contacts. (Add suffix /NC e.g. MQ45/SR/NC)	20A	1	31	MS15/SR
		20A	2	41	MD25/SR
		20A	3	51	MT35/SR
		20A	4	62	MQ45/SR
		20A	5	72	MX55/SR
		20A	6	82	MY65/SR
40A		1	35	RS3215/SR	
40A		2	49	RD3225/SR	
40A		3	62	RT3235/SR	
40A		4	74	RQ3245/SR	
40A		5	87	RX3255/SR	
40A		6	100	RY3265/SR	

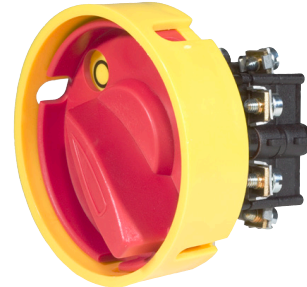

20A Minirotary switch fitted with the CSP1 Continental style locking handle

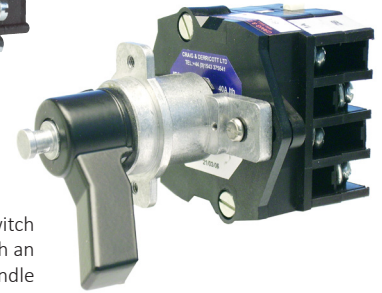

R40 rotary switch assembled with an 'SALHC' locking handle

Classic Rotary Switches - Heater

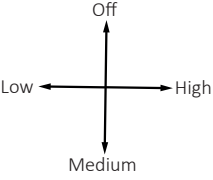
Restricted- 90° Three Position (Spring Return)- 1>Off/2				
Posn. Diag	Rating	Poles	'L'	Cat. No
Sequence- SEQ 7 	6A	1	42	R6S27
	6A	2	63	R6D47
	6A	3	84	R6T67
	16A	1	42	R16S27
	16A	2	63	R16D47
	16A	3	84	R16T67
	20A	1	41	MS27
	20A	2	62	MD47
	20A	3	82	MT67
	40A	1	49	RS3227
	40A	2	74	RD3247
	40A	3	100	RT3267

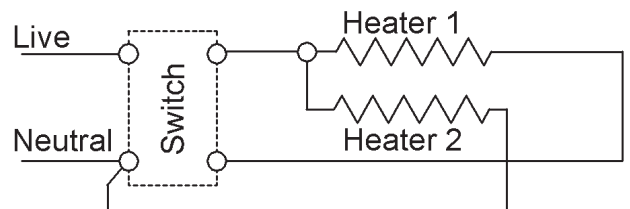

Heater Connection Schematic (Single Phase)

Technical Data Sheet

Classic Hand Operated Rotary Switches

CDPD182
Issue 1

Classic Rotary Switches - Cumulative

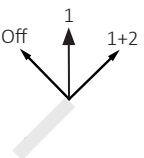
Restricted- 45° Three Position Stayput- Off/1/1+2				
Posn. Diag	Rating	Poles	'L'	Cat. No
Sequence- SEQ CUM1 	6A	1	31	R6S1CUM1
	6A	2	42	R6D2CUM1
	6A	3	52	R6T3CUM1
	6A	4	63	R6Q4CUM1
	6A	5	73	R6X5CUM1
	6A	6	84	R6Y6CUM1
	16A	1	31	R16S1CUM1
	16A	2	42	R16D2CUM1
	16A	3	52	R16T3CUM1
	16A	4	63	R16Q4CUM1
	16A	5	73	R16X5CUM1
	16A	6	84	R16Y6CUM1
	20A	1	31	MS1CUM1
	20A	2	41	MD2CUM1
	20A	3	51	MT3CUM1
	20A	4	62	MQ4CUM1
	20A	5	72	MX5CUM1
	20A	6	82	MY6CUM1
	40A	1	35	RS321CUM1
	40A	2	49	RD322CUM1
40A	3	62	RT323CUM1	
40A	4	74	RQ324CUM1	
40A	5	87	RX325CUM1	
40A	6	100	RY326CUM1	

Options for this sequence:-
NC- Electrically separate contacts.
(Add suffix /NC
e.g. MQ4CUM1/NC)

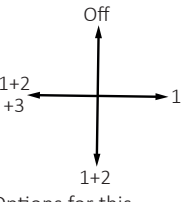
Unrestricted- 90° Four Position Stayput- Off/1/1+2/1+2+3				
Posn. Diag	Rating	Poles	'L'	Cat. No
Sequence- SEQ CUM2 	6A	1	52	R6S3CUM2
	6A	2	84	R6D6CUM2
	6A	3	115	R6T9CUM2
	16A	1	52	R16S3CUM2
	16A	2	84	R16D6CUM2
	16A	3	115	R16T9CUM2
	20A	1	51	MS3CUM2
	20A	2	82	MD6CUM2
	20A	3	113	MT9CUM2
	40A	1	62	RS323CUM2
	40A	2	100	RD326CUM2
	40A	3	138	RT329CUM2
	40A	4	175	RQ3212CUM2
	40A	5	213	RX3215CUM2
	40A	6	250	RY3218CUM1

Options for this sequence:-
NC- Electrically separate contacts.
(Add suffix /NC
e.g. R6T9CUM2/NC)

N.B. R6, R16 & MR switches are limited to a maximum of 10 switching wafers, and hence not all pole options are available in these ranges.

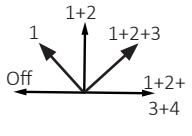
Restricted- 45° Five Position Stayput- Off/1/1+2/1+2+3/1+2+3+4				
Posn. Diag	Rating	Poles	'L'	Cat. No
Sequence- SEQ CUM3 	6A	1	63	R6S4CUM3
	6A	2	105	R6D8CUM3
	16A	1	63	R16S4CUM3
	16A	2	105	R16D8CUM3
	20A	1	62	MS4CUM3
	20A	2	103	MD8CUM3
	40A	1	74	RS324CUM3
	40A	2	125	RD328CUM3
	40A	3	175	RT3212CUM3
	40A	4	225	RQ3216CUM3
	40A	5	275	RX3220CUM3
	40A	6	327	RY3224CUM3

Options for this sequence:-
NC- Electrically separate contacts.
(Add suffix /NC
e.g. RS324CUM3/NC)

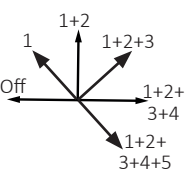
Restricted- 45° Six Position Stayput- Off/1/1+2/1+2+3/1+2+3+4/1+2+3+4+5				
Posn. Diag	Rating	Poles	'L'	Cat. No
Sequence- SEQ CUM4 	6A	1	73	R6S5CUM4
	6A	2	126	R6D10CUM4
	16A	1	73	R16S5CUM4
	16A	2	126	R16D10CUM4
	20A	1	72	MS5CUM4
	20A	2	124	MD10CUM4
	40A	1	87	RS325CUM4
	40A	2	150	RD3210CUM4
	40A	3	213	RT3215CUM4
	40A	4	275	RQ3220CUM4
	40A	5	289	RX3225CUM4
	40A	6	410	RY3230CUM4

Options for this sequence:-
NC- Electrically separate contacts.
(Add suffix /NC
e.g. R16S5CUM4/NC)

Technical Data Sheet

Classic Hand Operated Rotary Switches

CDPD182
Issue 1

Classic Rotary Switches - Ammeter / Voltmeter

Unrestricted- 900 Four Position Stayput- Off/L1/L2/L3

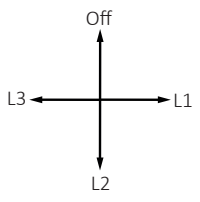
Posn. Diag	Rating	Poles	'L'	Cat. No
Sequence- SEQ AM1 	6A	-	63	R6AM1
	20A	-	62	MAM1
	40A	-	74	R32AM1

For C/T connection.
To meter the current in each phase with Off

Unrestricted- 900 Four Position Stayput- Out of Balance/L1/L2/L3

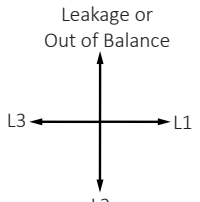
Posn. Diag	Rating	Poles	'L'	Cat. No
Sequence- SEQ AM2 Leakage or Out of Balance 	6A	-	63	R6AM2
	20A	-	62	MAM2
	40A	-	74	R32AM2

For C/T connection.
To meter the current in each phase with leakage or out of balance current

Unrestricted- 900 Four Position Stayput- Neutral/L1/L2/L3

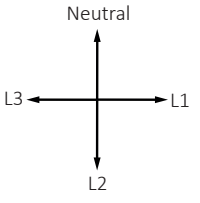
Posn. Diag	Rating	Poles	'L'	Cat. No
Sequence- SEQ AM3 Neutral 	6A	-	63	R6AM3
	20A	-	62	MAM3
	40A	-	74	R32AM3

For C/T connection.
To meter the current in each phase and neutral, with neutral C/T.

Unrestricted- 450 Eight Position Stayput- Off/L1-N/L2-N/L3-N/Off/L1-L2/L2-L3/L1-L3

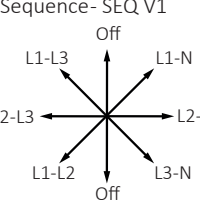
Posn. Diag	Rating	Poles	'L'	Cat. No
Sequence- SEQ V1 Off 	6A	-	84	R6V1
	20A	-	82	MV1
	40A	-	100	R32V1

Meters voltages between phases & between phases & neutral with Off

Unrestricted- 900 Four Position Stayput- Off/L1-N/L2-N/L3-N

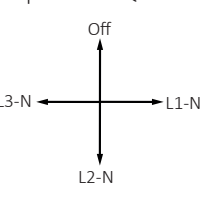
Posn. Diag	Rating	Poles	'L'	Cat. No
Sequence- SEQ V3 Off 	6A	-	52	R6V3
	20A	-	51	MV3
	40A	-	74	R32V3

Meters voltage between phases & neutral with Off. (Switched neutral)

Unrestricted- 900 Four Position Stayput- Off/L1-L2/L2-L3/L1-L3

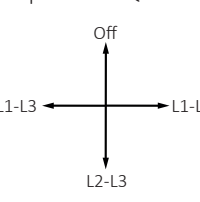
Posn. Diag	Rating	Poles	'L'	Cat. No
Sequence- SEQ V5 Off 	6A	-	52	R6V5
	20A	-	51	MV5
	40A	-	74	R32V5

Meters voltages between phases with Off

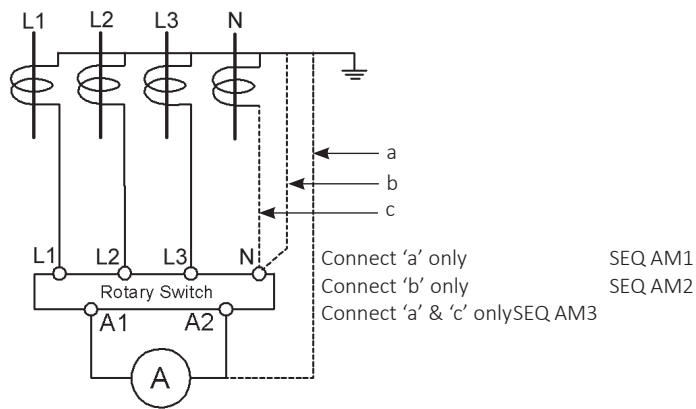

Application Schematic for Ammeter Switches

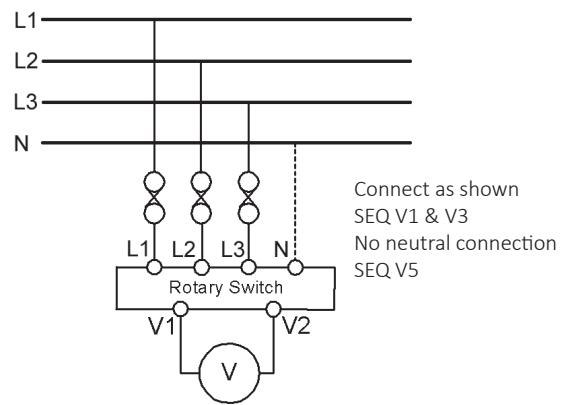

Application Schematic for Voltmeter Switches

Technical Data Sheet

Classic Hand Operated Rotary Switches

CDPD182
Issue 1

Classic Rotary Switches - Motor Control

Unrestricted- 90° Four Position Stayput- For/Rev/For/Rev				
Posn. Diag	Rating	Poles	'L'	Cat. No
Sequence- SEQ 8 	6A	2	42	R6D28
	16A	2	42	R16D28
	20A	2	41	MD28
	40A	2	49	RD3228

Unrestricted- 90° Four Position Stayput- Off/For/Off/Rev				
Posn. Diag	Rating	Poles	'L'	Cat. No
Sequence SEQ 9 	6A	2	42	R6D29
	6A	3	52	R6T39
	16A	2	42	R16D29
	16A	3	52	R16T39
	20A	2	41	MD29
	20A	3	51	MT39
	40A	2	49	RD3229
	40A	3	62	RT3239

Restricted- 90° Two Position Stayput- For/Rev				
Posn. Diag	Rating	Poles	'L'	Cat. No
Sequence- SEQ 8/2 	6A	2	42	R6D28/2
	16A	2	42	R16D28/2
	20A	2	41	MD28/2
	40A	2	49	RD3228/2

Restricted- 450 Three Position Stayput- For/Off/Rev				
Posn. Diag	Rating	Poles	'L'	Cat. No
Sequence SEQ 9/3 	6A	2	42	R6D29/3
	6A	3	52	R6T39/3
	16A	2	42	R16D29/3
	16A	3	52	R16T39/3
	20A	2	41	MD29/3
	20A	3	51	MT39/3
	40A	2	49	RD3229/3
	40A	3	62	RT3239/3

Restricted- 450 Two Position Spring Return- For<Rev				
Posn. Diag	Rating	Poles	'L'	Cat. No
Sequence- SEQ 8/SR 	6A	2	42	R6D28/SR
	16A	2	42	R16D28/SR
	20A	2	41	MD28/SR
	40A	2	49	RD3228/SR

Restricted- 450 Three Position Spring Return- For>Off<Rev				
Posn. Diag	Rating	Poles	'L'	Cat. No
Sequence SEQ 9/SR 	6A	2	42	R6D29/SR
	6A	3	52	R6T39/SR
	16A	2	42	R16D29/SR
	16A	3	52	R16T39/SR
	20A	2	41	MD29/SR
	20A	3	51	MT39/SR
	40A	2	49	RD3229/SR
	40A	3	62	RT3239/SR

Connection diagram for utilising a three phase reversing switch for a single phase motor.

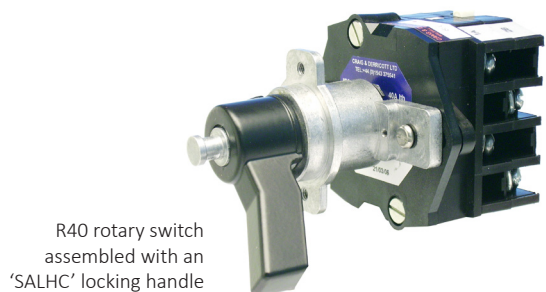
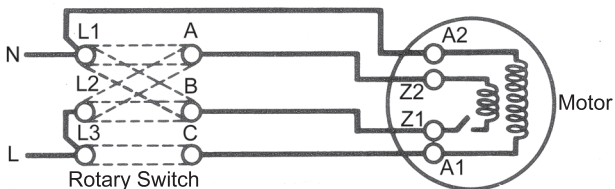

R40 rotary switch assembled with an 'SALHC' locking handle

Technical Data Sheet

Classic Hand Operated Rotary Switches

CDPD182
Issue 1

Classic Rotary Switches - Multi-Position

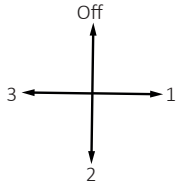
Unrestricted- 900 Four Position Stayput- Off/1/2/3				
Posn. Diag	Rating	Poles	'L'	Cat. No
Sequence- SEQ 4  Options for this sequence:- MBB- Make before break contacts (Add suffix /MBB) NC- Electrically separate contacts. (Add suffix /NC e.g. R16Q84/NC)	6A	1	42	R6S24
	6A	2	63	R6D44
	6A	3	84	R6T64
	6A	4	105	R6Q84
	6A	5	126	R6X104
	16A	1	42	R16S24
	16A	2	63	R16D44
	16A	3	84	R16T64
	16A	4	105	R16Q84
	16A	5	126	R16X104
	20A	1	42	MS24
	20A	2	62	MD44
	20A	3	82	MT64
	20A	4	103	MQ84
	20A	5	124	MX104
	40A	1	49	RS3224
	40A	2	74	RD3244
	40A	3	100	RT3264
	40A	4	125	RQ3284
	40A	5	150	RX32104
40A	6	175	RY32124	

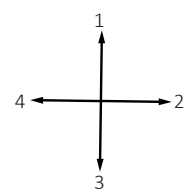
Unrestricted- 900 Four Position Stayput- 1/2/3/4				
Posn. Diag	Rating	Poles	'L'	Cat. No
Sequence- SEQ 5  Options for this sequence:- MBB- Make before break contacts (Add suffix /MBB) NC- Electrically separate contacts. (Add suffix /NC e.g. RY32125/NC)	6A	1	42	R6S25
	6A	2	63	R6D45
	6A	3	84	R6T65
	6A	4	105	R6Q85
	6A	5	126	R6X105
	6A	1	42	R16S25
	16A	2	63	R16D45
	16A	3	84	R16T65
	16A	4	105	R16Q85
	16A	5	126	R16X105
	16A	1	42	MS25
	16A	2	62	MD45
	20A	3	82	MT65
	20A	4	103	MQ85
	20A	5	124	MX105
	20A	1	49	RS3225
	20A	2	74	RD3245
	20A	3	100	RT3265
	40A	4	125	RQ3285
	40A	5	150	RX32105
40A	6	175	RY32125	

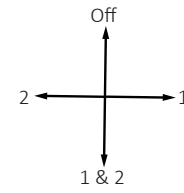
Unrestricted- 900 Four Position Stayput- Off/1/1&2/2				
Posn. Diag	Rating	Poles	'L'	Cat. No
Sequence- SEQ 6  	6A	1	42	R6S2
	6A	2	63	R6D46
	6A	3	84	R6T66
	6A	4	105	R6Q86
	6A	5	126	R6X106
	6A	1	42	R16S26
	16A	2	63	R16D46
	16A	3	84	R16T66
	16A	4	105	R16Q86
	16A	5	126	R16X106
	16A	1	42	MS26
	16A	2	62	MD46
	20A	3	82	MT66
	20A	4	103	MQ86
	20A	5	124	MX106
	20A	1	49	RS3226
	20A	2	74	RD3246
	20A	3	100	RT3266
	40A	4	125	RQ3286
	40A	5	150	RX32106
40A	6	175	RY32126	

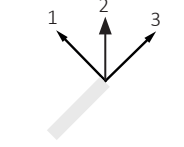
Restricted- 450 Three Position Stayput- 1/2/3				
Posn. Diag	Rating	Poles	'L'	Cat. No
Sequence- SEQ 4/3  Options for this sequence:- NC- Electrically separate contacts. (Add suffix /NC e.g. MQ64/3/NC)	6A	1	42	R6S24/3
	6A	2	52	R6D34/3
	6A	3	73	R6T54/3
	6A	4	84	R6Q64/3
	6A	5	105	R6X84/3
	6A	6	115	R6Y94/3
	16A	1	42	R16S24/3
	16A	2	52	R16D34/3
	16A	3	73	R16T54/3
	16A	4	84	R16Q64/3
	16A	5	105	R16X84/3
	16A	6	115	R16Y94/3
	20A	1	41	MS24/3
	20A	2	51	MD34/3
	20A	3	72	MT54/3
	20A	4	82	MQ64/3
	20A	5	103	MX84/3
	20A	6	113	MY94/3
	40A	1	35	RS3224/3
	40A	2	49	RD3234/3
40A	3	62	RT3254/3	
40A	4	74	RQ3264/3	
40A	5	87	RX3284/3	
40A	6	100	RY3294/3	



R40 rotary switch assembled with an 'SALHC' locking handle

Switches with a greater number of poles than those shown are available to special order. Please contact our sales staff for details.

Technical Data Sheet

Classic Hand Operated Rotary Switches

CDPD182
Issue 1

Classic Rotary Switches - Multi-Position

Restricted- 450 Five Position Stayput- 1/2/Off/3/4

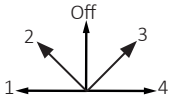
Posn. Diag	Rating	Poles	'L'	Cat. No
 <p>Options for this sequence:- NC- Electrically separate contacts. (Add suffix /NC e.g. MQ85/4/NC)</p>	6A	1	42	R6S25/4
	6A	2	63	R6D45/4
	6A	3	84	R6T65/4
	6A	4	105	R6Q85/4
	6A	5	126	R6X105/4
	16A	1	42	R16S25/4
	16A	2	63	R16D45/4
	16A	3	84	R16T65/4
	16A	4	105	R16Q85/4
	16A	5	126	R16X105/4
	20A	1	41	MS25/4
	20A	2	62	MD45/4
	20A	3	82	MT65/4
	20A	4	103	MQ85/4
	20A	5	124	MX105/4
	40A	1	49	RS3225/4
	40A	2	74	RD3245/4
	40A	3	100	RT3265/4
	40A	4	125	RQ3285/4
	40A	5	150	RX32105/4
40A	6	175	RY32125/4	

Restricted- 450 Five Position Stayput- 1/2/3/4/5

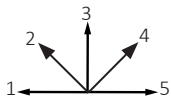
Posn. Diag	Rating	Poles	'L'	Cat. No
 <p>Options for this sequence:- NC- Electrically separate contacts. (Add suffix /NC e.g. MD56/4/NC)</p>	6A	1	52	R6S36/4
	6A	2	73	R6D56/4
	6A	3	105	R6T86/4
	6A	4	126	R6Q106/4
	16A	1	52	R16S36/4
	16A	2	73	R16D56/4
	16A	3	105	R16T86/4
	16A	4	126	R16Q106/4
	20A	1	51	MS36/4
	20A	2	72	MD56/4
	20A	3	103	MT86/4
	20A	4	124	MQ106/4
	40A	1	62	RS3236/4
	40A	2	87	RD3256/4
	40A	3	125	RT3286/4
	40A	4	150	RQ32106/4
	40A	5	188	RX32136/4
	40A	6	213	RY32156/4

Restricted- 450 Six Position Stayput- Off/1/2/3/4/5

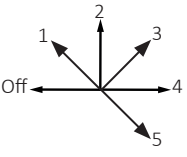
Posn. Diag	Rating	Poles	'L'	Cat. No
 <p>Options for this sequence:- NC- Electrically separate contacts. (Add suffix /NC e.g. R6T97/4/NC)</p>	6A	1	52	R6S37/4
	6A	2	84	R6D67/4
	6A	3	115	R6T97/4
	16A	1	52	R16S37/4
	16A	2	84	R16D67/4
	16A	3	115	R16T97/4
	20A	1	51	MS37/4
	20A	2	82	MD67/4
	20A	3	113	MT97/4
	40A	1	62	RS3237/4
	40A	2	100	RD3267/4
	40A	3	138	RT3297/4
	40A	4	175	RQ32127/4
	40A	5	213	RX32157/4
	40A	6	250	RY32187/4

Restricted- 450 Six Position Stayput- 1/2/3/4/5/6

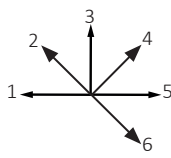
Posn. Diag	Rating	Poles	'L'	Cat. No
 <p>Options for this sequence:- NC- Electrically separate contacts. (Add suffix /NC e.g. RT3298/4/NC)</p>	6A	1	52	R6S38/4
	6A	2	84	R6D68/4
	6A	3	115	R6T98/4
	16A	1	52	R16S38/4
	16A	2	84	R16D68/4
	16A	3	115	R16T98/4
	20A	1	51	MS38/4
	20A	2	82	MD68/4
	20A	3	113	MT98/4
	40A	1	62	RS3238/4
	40A	2	100	RD3268/4
	40A	3	138	RT3298/4
	40A	4	175	RQ32128/4
	40A	5	213	RX32158/4
	40A	6	250	RY32188/4

Restricted- 450 Seven Position Stayput- 1/2/3/4/5/6/7

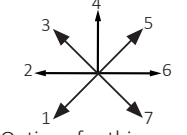
Posn. Diag	Rating	Poles	'L'	Cat. No
 <p>Options for this sequence:- NC- Electrically separate contacts. (Add suffix /NC e.g. RX321810/4/NC)</p>	6A	1	63	R6S410/4
	6A	2	94	R6D710/4
	16A	1	63	R16S410/4
	16A	2	94	R16D710/4
	20A	1	62	MS410/4
	20A	2	93	MD710/4
	40A	1	74	RS32410/4
	40A	2	112	RD32710/4
	40A	3	163	RT32110/4
	40A	4	200	RQ321410/4
	40A	5	250	RX321810/4
	40A	6	288	RY322110/4

Restricted- 450 Seven Position Stayput- 1/2/3/Off/4/5/6

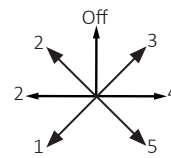
Posn. Diag	Rating	Poles	'L'	Cat. No
 <p>Options for this sequence:- NC- Electrically separate contacts. (Add suffix /NC e.g. R6S39/4/NC)</p>	6A	1	52	R6S39/4
	6A	2	84	R6D69/4
	6A	3	115	R6T99/4
	16A	1	52	R16S39/4
	16A	2	84	R16D69/4
	16A	3	115	R16T99/4
	20A	1	51	MS39/4
	20A	2	82	MD69/4
	20A	3	113	MT99/4
	40A	1	62	RS3239/4
	40A	2	100	RD3269/4
	40A	3	138	RT3299/4
	40A	4	175	RQ32129/4
	40A	5	213	RX32159/4
	40A	6	250	RY32189/4

Technical Data Sheet

Classic Hand Operated Rotary Switches

CDPD182
Issue 1

Classic Rotary Switches - Multi-Position

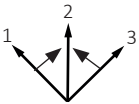
Restricted- 450 Three Position Spring Return- 1>2<3				
Posn. Diag	Rating	Poles	'L'	Cat. No
Sequence- SEQ 4/SR 	6A	1	42	R6S24/SR
	6A	2	52	R6D34/SR
	6A	3	73	R6T54/SR
	6A	4	84	R6Q64/SR
	16A	1	42	R16S24/SR
	16A	2	52	R16D34/SR
	16A	3	73	R16T54/SR
	16A	4	84	R16Q64/SR
	20A	1	41	MS24/SR
	20A	2	51	MD34/SR
	20A	3	72	MT54/SR
	20A	4	82	MQ64/SR
	40A	1	49	RS3224/SR
	40A	2	62	RD3234/SR
	40A	3	87	RT3254/SR
	40A	4	100	RQ3264/SR
40A	5	125	RX3284/SR	
40A	6	138	RY3294/SR	

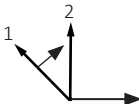
Restricted- 900 Three Position (Spring Return)- 1>2/3				
Posn. Diag	Rating	Poles	'L'	Cat. No
Sequence- SEQ 6/SR 	6A	1	42	R6S26/SR
	6A	2	52	R6D36/SR
	6A	3	73	R6T56/SR
	6A	4	84	R6Q64/SR
	16A	1	42	R16S26/SR
	16A	2	52	R16D36/SR
	16A	3	73	R16T56/SR
	16A	4	84	R16Q66/SR
	20A	1	41	MS26/SR
	20A	2	51	MD36/SR
	20A	3	72	MT56/SR
	20A	4	82	MQ66/SR
	40A	1	49	RS3226/SR
	40A	2	62	RD3236/SR
	40A	3	87	RT3256/SR
	40A	4	100	RQ3266/SR
40A	5	125	RX3286/SR	
40A	6	138	RY3296/SR	

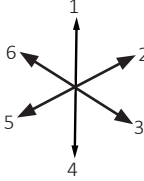
Unrestricted- 600 Six Position Stayput- 1/2/3/4/5/6				
Posn. Diag	Rating	Poles	'L'	Cat. No
Sequence- SEQ 1/6 	40A	1	62	RS3231/6
	40A	2	100	RD3261/6
	40A	3	138	RT3291/6

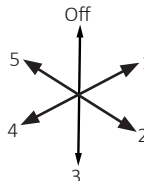
Unrestricted- 600 Six Position Stayput- Off/1/2/3/4/5				
Posn. Diag	Rating	Poles	'L'	Cat. No
Sequence- SEQ 2/6 	40A	1	62	RS3232/6
	40A	2	100	RD3262/6
	40A	3	138	RT3292/6

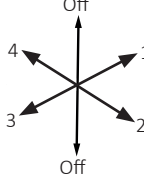
Unrestricted- 600 Six Position Stayput- Off/1/2/Off/3/4				
Posn. Diag	Rating	Poles	'L'	Cat. No
Sequence- SEQ 3/6 	40A	1	49	RS3223/6
	40A	2	74	RD3243/6
	40A	3	100	RT3263/6

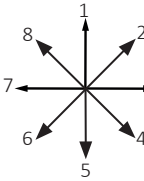
Unrestricted- 450 Eight Position Stayput- 1/2/3/4/5/6/7/8				
Posn. Diag	Rating	Poles	'L'	Cat. No
Sequence- SEQ 1/8 	6A	1	63	R6S41/8
	6A	2	105	R6D81/8
	16A	1	63	R16S41/8
	16A	2	105	R16D81/8
	20A	1	62	MS41/8
	20A	2	103	MD81/8
	40A	1	74	RS3241/8
	40A	2	125	RD3281/8
	40A	3	175	RT32121/8

Technical Data Sheet

Classic Hand Operated Rotary Switches

CDPD182
Issue 1

Classic Rotary Switches - Multi-Position

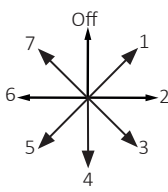
Unrestricted- 450 Eight Position Stayput- Off/1/2/3/4/5/6/7				
Posn. Diag	Rating	Poles	'L'	Cat. No
Sequence- SEQ 2/8 	6A	1	63	R6S42/8
	6A	2	105	R6D82/8
	16A	1	63	R16S42/8
	16A	2	105	R16D82/8
	20A	1	62	MS42/8
	20A	2	103	MD82/8
	40A	1	74	RS3242/8
	40A	2	125	RD3282/8
	40A	3	175	RT32122/8

Option for all sequences on this page:- NC- Electrically separate contacts.
Add suffix /NC e.g. R6S33/8/NC

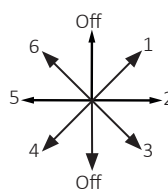
Unrestricted- 450 Eight Position Stayput- Off/1/2/3/Off/4/5/6				
Posn. Diag	Rating	Poles	'L'	Cat. No
Sequence- SEQ 3/8 	6A	1	52	R6S33/8
	6A	2	84	R6D63/8
	6A	3	115	R6T93/8
	16A	1	52	R16S33/8
	16A	2	84	R16D63/8
	16A	3	115	R16T93/8
	20A	1	51	MS33/8
	20A	2	82	MD63/8
	20A	3	113	MT93/8
	40A	1	62	RS3233/8
	40A	2	100	RD3263/8
	40A	3	138	RT3293/8

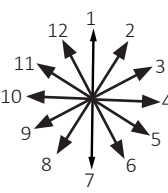
Unrestricted- 300 12 Position Stayput- 1/2/3/4/5/6/7/8/9/10/11/12				
Posn. Diag	Rating	Poles	'L'	Cat. No
Sequence- SEQ 1/12 	40A	1	100	RS3261/12
	40A	2	175	RD32121/12
	40A	3	250	RT32181/12

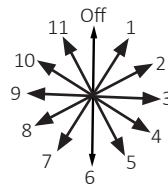
Unrestricted- 300 12 Position Stayput- Off/2/3/4/5/6/7/8/9/10/11				
Posn. Diag	Rating	Poles	'L'	Cat. No
Sequence- SEQ 2/12 	40A	1	100	RS3262/12
	40A	2	175	RD32122/12
	40A	3	250	RT32182/12

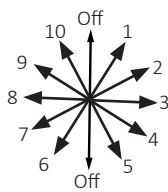
Unrestricted- 300 12 Position Stayput- Off/2/3/4/5/Off/7/8/9/10				
Posn. Diag	Rating	Poles	'L'	Cat. No
Sequence- SEQ 3/12 	40A	1	87	RS3253/12
	40A	2	150	RD32103/12
	40A	3	213	RT32153/12

Option for all sequences on this page:- NC- Electrically separate contacts.
Add suffix /NC e.g. RT32153/12/NC

Technical Data Sheet

Classic Hand Operated Rotary Switches

CDPD182
Issue 1

Classic Rotary Switches - Off / On

Unrestricted- 900 Four Position Stayput- Off/On/Off/On					
Posn. Diag	Rating	Poles	'L'	Cat. No	
Sequence- SEQ1 	6A	1	31	R6S11	
	6A	2	31	R6D11	
	6A	3	42	R6T21	
	6A	4	42	R6Q21	
	6A	5	52	R6X31	
	6A	6	52	R6Y31	
	16A	1	31	R16S11	
	16A	2	31	R16D11	
	16A	3	42	R16T21	
	16A	4	42	R16Q21	
	16A	5	52	R16X31	
	16A	6	52	R16Y31	
	20A	1	31	MS11	
	20A	2	31	MD11	
	20A	3	41	MT21	
	20A	4	41	MQ21	
	20A	5	51	MX31	
	20A	6	51	MY31	
	Options for this sequence:- EB- Early break aux. contact. (Add suffix /1EB e.g. MT21/1EB)	40A	1	35	RS3211
		40A	2	35	RD3211
	40A	3	49	RT3221	
	40A	4	49	RQ3221	
	40A	5	62	RX3231	
	40A	6	62	RY3231	

Restricted- 900 Two Position Stayput- Off/On					
Posn. Diag	Rating	Poles	'L'	Cat. No	
Sequence- SEQ1/1 	6A	1	31	R6S11/1	
	6A	2	31	R6D11/1	
	6A	3	42	R6T21/1	
	6A	4	42	R6Q21/1	
	6A	5	52	R6X31/1	
	6A	6	52	R6Y31/1	
	16A	1	31	R16S11/1	
	16A	2	31	R16D11/1	
	16A	3	42	R16T21/1	
	16A	4	42	R16Q21/1	
	16A	5	52	R16X31/1	
	16A	6	52	R16Y31/1	
	20A	1	31	MS11/1	
	20A	2	31	MD11/1	
	20A	3	41	MT21/1	
	20A	4	41	MQ21/1	
	20A	5	51	MX31/1	
	20A	6	51	MY31/1	
	Options for this sequence:- EB- Early break aux. contact. (Add suffix /1EB e.g. MT21/1EB)	40A	1	35	RS3211/1
		40A	2	35	RD3211/1
	40A	3	49	RT3221/1	
	40A	4	49	RQ3221/1	
	40A	5	62	RX3231/1	
	40A	6	62	RY3231/1	

Restricted- 900/450 Two Position Stayput- Off/On					
Posn. Diag	Rating	Poles	'L'	Cat. No	
Sequence- SEQ1/2 	6A	1	31	R6S11/2	
	6A	2	31	R6D11/2	
	6A	3	42	R6T21/2	
	6A	4	42	R6Q21/2	
	6A	5	52	R6X31/2	
	6A	6	52	R6Y31/2	
	16A	1	31	R16S11/2	
	16A	2	31	R16D11/2	
	16A	3	42	R16T21/2	
	16A	4	42	R16Q21/2	
	16A	5	52	R16X31/2	
	16A	6	52	R16Y31/2	
	20A	1	31	MS11/2	
	20A	2	31	MD11/2	
	20A	3	41	MT21/2	
	20A	4	41	MQ21/2	
	20A	5	51	MX31/2	
	20A	6	51	MY31/2	
	Options for this sequence:- EB- Early break aux. contact. (Add suffix /1EB e.g. MT21/1EB)	40A	1	35	RS3211/2
		40A	2	35	RD3211/2
	40A	3	49	RT3221/2	
Padlocking Handles See page 3 for details	40A	4	49	RQ3221/2	
	40A	5	62	RX3231/2	
	40A	6	62	RY3231/2	

Restricted- 900 Two Position Spring Return- Off/On					
Posn. Diag	Rating	Poles	'L'	Cat. No	
Sequence- SEQ1/SR 	6A	1	31	R6S11/SR	
	6A	2	31	R6D11/SR	
	6A	3	42	R6T21/SR	
	6A	4	42	R6Q21/SR	
	6A	5	52	R6X31/SR	
	6A	6	52	R6Y31/SR	
	16A	1	31	R16S11/SR	
	16A	2	31	R16D11/SR	
	16A	3	42	R16T21/SR	
	16A	4	42	R16Q21/SR	
	16A	5	52	R16X31/SR	
	16A	6	52	R16Y31/SR	
	20A	1	31	MS11/SR	
	20A	2	31	MD11/SR	
	20A	3	41	MT21/SR	
	20A	4	41	MQ21/SR	
	20A	5	51	MX31/SR	
	20A	6	51	MY31/SR	
		40A	1	35	RS3211/SR
		40A	2	35	RD3211/SR
	40A	3	49	RT3221/SR	
	40A	4	49	RQ3221/SR	
	40A	5	62	RX3231/SR	
	40A	6	62	RY3231/SR	

Technical Data Sheet

Classic Hand Operated Rotary Switches

CDPD182
Issue 1

Classic Rotary Switches - Off / On

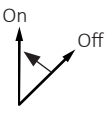
Restricted- 900 Two Position Spring Return- On/Off (7/SR)				
Posn. Diag	Rating	Poles	'L'	Cat. No
Sequence- SEQ7/SR 	6A	1	31	R6S17/SR
	6A	2	31	R6D17/SR
	6A	3	42	R6T27/SR
	6A	4	42	R6Q27/SR
	6A	5	52	R6X37/SR
	6A	6	52	R6Y37/SR
	16A	1	31	R16S17/SR
	16A	2	31	R16D17/SR
	16A	3	42	R16T27/SR
	16A	4	42	R16Q27/SR
	16A	5	52	R16X37/SR
	16A	6	52	R16Y37/SR
	20A	1	31	MS17/SR
	20A	2	31	MD17/SR
	20A	3	41	MT27/SR
	20A	4	41	MQ27/SR
	20A	5	51	MX37/SR
	20A	6	51	MY37/SR
	40A	1	35	RS3217/SR
	40A	2	35	RD3217/SR
	40A	3	49	RT3227/SR
	40A	4	49	RQ3227/SR
	40A	5	62	RX3237/SR
	40A	6	62	RY3237/SR

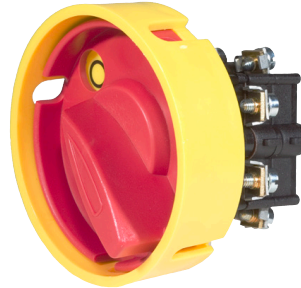

20A Mini-rotary switch fitted with the CSP1 Continental style locking handle

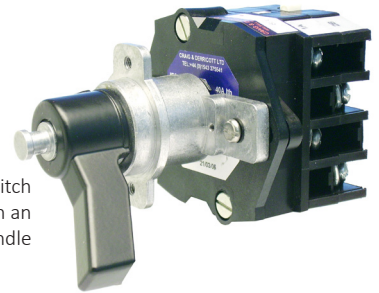

R40 rotary switch assembled with an 'SALHC' locking handle

Technical Data Sheet

Classic Hand Operated Rotary Switches

CDPD182
Issue 1

Classic Rotary Switches - Accessories



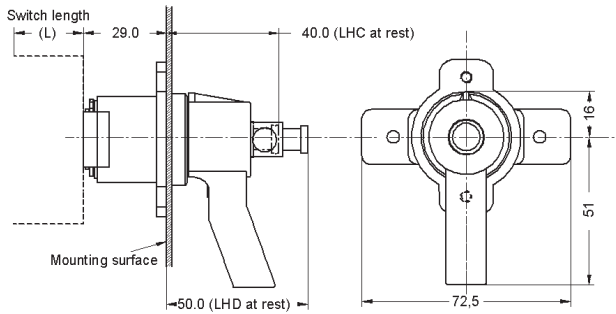

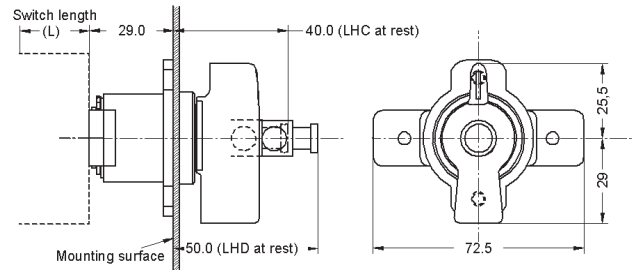

LHC/LHD Locking Handle with SA shape knob

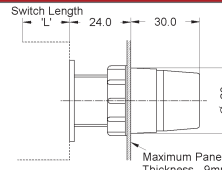

LHC/LHD Locking Handle with SM shape knob

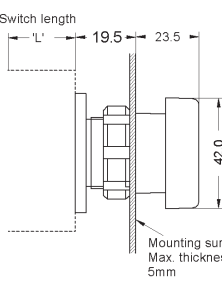

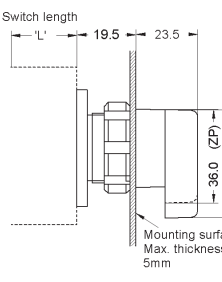
x = Not available, ✓ = OK

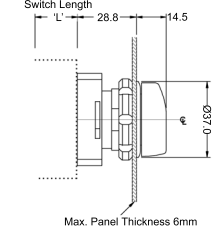
Image	Dimensions	Description	R6	R16	MR	R40	Cat. No
		IP65 Knob actuator- single hole fixing Ø22 mounting moulded plastic body Cannot be sold separately	✓	✓	✓	x	22Z/
		IP65 Knob actuator- single hole fixing Ø22 mounting die-cast aluminium body Tee bar knob with full width line	x	x	✓	x	22/ZTF
		IP65 Knob actuator- single hole fixing Ø22 mounting die-cast aluminium body Tee bar knob with half width line	x	x	✓	x	22/ZT
		IP65 Knob actuator- single hole fixing Ø22 mounting die-cast aluminium body Pointer knob with short tail	x	x	✓	x	22/KP
		IP65 Knob actuator- single hole fixing Ø22 mounting die-cast aluminium body Pointer knob with long tail	x	x	✓	x	22/ZPL
		IP65 Knob actuator- single hole fixing Ø30.5 mounting die-cast aluminium body Pointer knob Cannot be sold separately					N309B1

Technical Data Sheet

Classic Hand Operated Rotary Switches

CDPD182
Issue 1

Classic Rotary Switches - Accessories

x = Not available, ✓ = OK

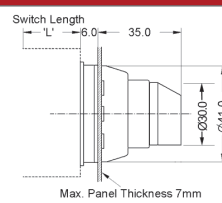

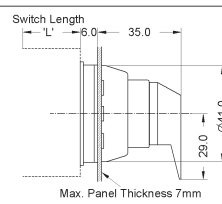

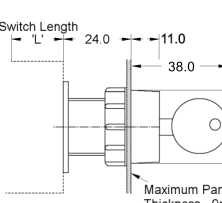

Image	Dimensions	Description	R6	R16	MR	R40	Cat. No
		IP65 Knob actuator- single hole fixing Ø32 mounting die-cast aluminium body & knob with silver anodised finish locking ring Pointer knob Cannot be sold separately	✓	✓	✓	x	Z
		IP65 Knob actuator- single hole fixing Ø32 mounting die-cast aluminium body & knob with silver anodised finish locking ring Metal pointer knob Cannot be sold separately	x	x	✓	x	Z1

Image	Dimensions	Description	R6	R16	MR	R40	Cat. No
		IP65 Key Actuator- single hole fixing. Ø22 mounting moulded body Actuators supplied with 2 off '301' keys. Key differs 302- 399 available on request Locking positions					
		12:00 o'clock SEQ 2/1 12:00 & 3:00 o'clock	✓	✓	✓	x	22K1 22K2
		12:00 o'clock only SEQ 3/4 12:00, 9:00 & 3:00 o'clock	✓	✓	✓	x	22K3 22K4
		12:00 & 6:00 o'clock SEQ 2/3 12:00/3:00/6:00/9:00 o'clock	✓	✓	✓	x	22K5 22K6
		10:30 o'clock 10:30 & 1:30 o'clock SEQ 2/2 1:30 o'clock	✓	✓	✓	x	22K9 22K10 22K11
		12:00 o'clock only SEQ 2/SR	✓	✓	✓	x	22K20
		12:00 o'clock only SEQ 3/SR	✓	✓	✓	x	22K21
				IP65 Key Actuator- single hole fixing. Ø32 mounting die-cast aluminium body Actuators supplied with 2 off 'DC800' keys. Key differs DC801- DC899 available on request Locking positions			
12:00 & 6:00 o'clock SEQ 2&3 12:00/3:00/6:00/9:00 o'clock	x			x	✓	x	K5 K6
12:00 o'clock only SEQ 2/1 12:00 & 3:00 o'clock	x			x	✓	x	K1 K2
10:30 o'clock only 10:30 & 1:30 o'clock SEQ 2/2 1:30 o'clock only	x			x	✓	x	K9 K10 K11
12:00 o'clock only SEQ 3/3	x			x	✓	x	K20
12:00 o'clock only SEQ 3/4 12:00, 9:00 & 3:00 o'clock	x			x	✓	x	K3 K4
12:00 o'clock SEQ 2/SR	x			x	✓	x	K20
12:00 o'clock SEQ 3/SR	x			x	✓	x	K21

Technical Data Sheet

Classic Hand Operated Rotary Switches

CDPD182
Issue 1

Classic Rotary Switches - Accessories

x = Not available, ✓ = OK

Image	Dimensions	Description	R6	R16	MR	R40	Cat. No
		Moulded skirted knob Ø26 Supplied as standard with R6 & R16 switch Supplied loose as spare	✓ ✓	✓ ✓	x x	x x	- MZK/B/HAN
		Moulded skirted knob Ø35 Supplied fitted to selected switch Supplied loose as spare	✓ ✓	✓ ✓	x x	✓ ✓	.../ZK ZK/B/HAN
		Moulded skirted knob Ø35 Supplied as standard with mini-rotary switch Supplied loose as spare	x x	x x	✓ ✓	x x	- SZK/B/HAN
		Moulded skirted knob Ø35 with tail Supplied as standard with R40 switch Supplied fitted to selected switch Supplied loose as spare	x ✓ ✓	x ✓ ✓	x x x	✓ x ✓	- /SK SK/B/HAN
		Moulded skirted knob Ø50 with tail Supplied fitted to selected switch Supplied loose as spare	x x	x x	x x	✓ ✓	/LK LK/B/HAN
		Moulded pistol grip handle- Black Supplied fitted to selected switch Supplied loose as spare	x x	x x	x x	✓ ✓	/BP BP/B/HAN
		Die-Cast knobs- General purpose pointer style knob Supplied fitted to selected switch Supplied loose as spare (mini-rotary) Supplied loose as spare (R40)	x x x	x x x	✓ ✓ x	✓ x ✓	/SM SM/16/HAN SM/32/HAN
		Die-Cast knobs- Pointer style knob with tail Supplied fitted to selected switch Supplied loose as spare (mini-rotary) Supplied loose as spare (R40)	x x x	x x x	✓ ✓ x	✓ x ✓	/SA SA/16/HAN SA/32/HAN

Technical Data Sheet

Classic Hand Operated Rotary Switches

CDPD182
Issue 1

Image	Dimensions	Description	R6	R16	MR	R40	Cat. No
		Die-Cast knobs- Machine Tool style (Small) Bright chrome finish with black ball knob Supplied fitted to selected switch Supplied loose as spare (mini-rotary) Supplied loose as spare (R16/R16/R40) * Only suitable for non-restricted switches	✓* x ✓*	✓* x ✓*	✓ ✓ x	✓ x ✓	/SMT SMT/16/HAN SMT/32/HAN

Image	Dimensions	Description	R6	R16	MR	R40	Cat. No
		Extended Shafts Total shaft projection (4.8 sq) 20.5 25.5 33.5 40.0 46.0 52.5 59.0 Total shaft projection (5.5 sq) 23.5 36.5 49.0 62.0 75.0 87.5 100.0	x x x x x x x x x x x x x x x x x x x x	x x x x x x x x x x x x x x x x x x x x	✓ ✓ ✓ ✓ ✓ ✓ ✓ x x x x x x x x x x x x x	x x x x x x x x x x x x x x x x x x x x	(Std. Shaft) /SS1 /SS2 /SS3 /SS4 /SS5 /SS6 (Std. Shaft) /SS2 /SS4 /SS6 /SS8 /SS10 /SS12
		Gold surfaced contacts for low power circuits Gold flashed contacts Gold plated contacts Plated contacts offer a significantly thicker deposit and are better suited to withstand mechanical wear and minor contact arcing.	✓ x	✓ x	✓ ✓	x x	/GF /GP
		IP65 Sealing Kit to enhance the standard panel mounting switches to IP65 Factory fitted to switch Supplied loose as kit (mini-rotary) Supplied loose as kit (R40)	✓ x x	✓ x x	✓ ✓ x	✓ x ✓	/G G/16/KIT G/32/KIT
		Base Mounting- Provides the facility to base mount the panel mounted switch form Base mounted form	✓	✓	✓	✓	B
		Heavy duty, all metal, padlocking faceplate. Can be made lockable in one or more position (450 indexing). Basic padlocking device	x	x	x	✓	/PL
		Additional terminal protection Individual terminal shrouds (R6/R16) Individual terminal shrouds (mini-rotary) Flexible PVC shroud* *Designed to cover the complete switch and associated wiring. Easily cut to length to suit individual switch lengths.	✓ x x	✓ x x	x ✓ ✓	x x x	SRC 0108 MR 1048 MR 0134

Technical Data Sheet

Classic Hand Operated Rotary Switches

CDPD182
Issue 1

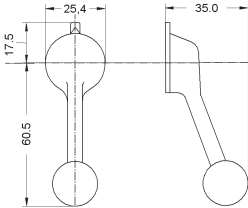
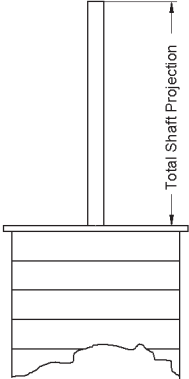
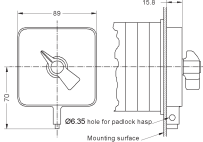
Classic Rotary Switches - Dimensions

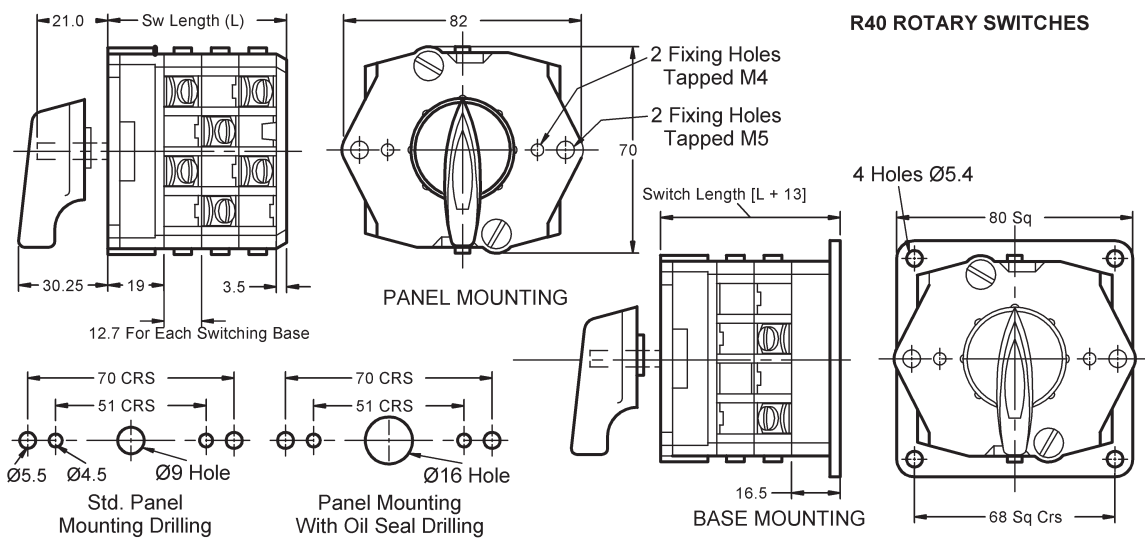
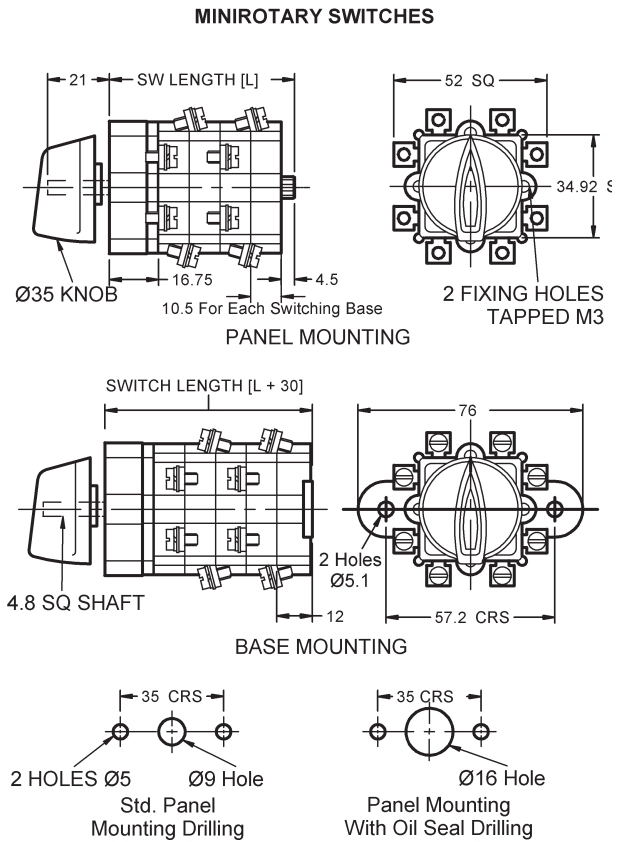
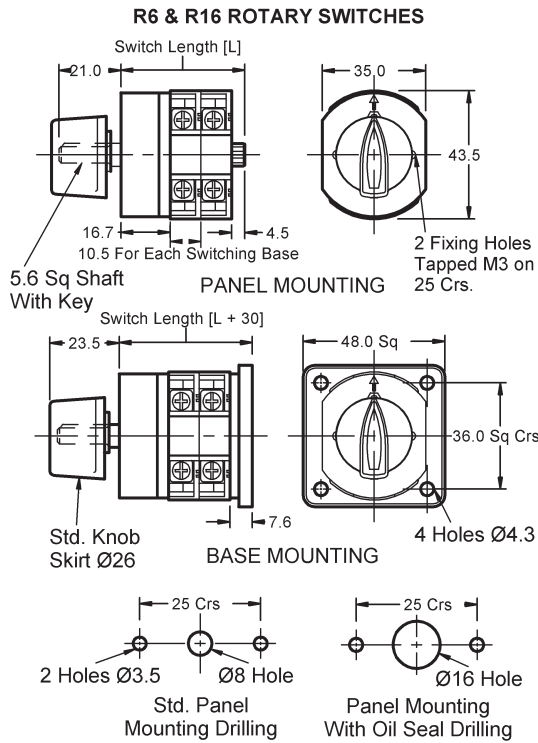

Single hole mounted components:-

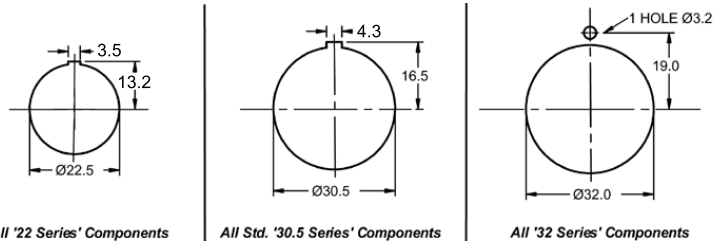



**SCATTERGOOD
& JOHNSON LTD**
ELECTRICAL ENGINEERING & FLUID CONTROL DISTRIBUTORS

Est.1899

At Scattergood & Johnson Ltd, we pride ourselves on being a technical distributor to specialist industries.

Working with a range of quality product manufacturers across a number of specialist markets, we are not your average 'box shifter' - we are your technical and supply chain partner.

We fully support every product we sell - for free! Our internal team and external sales engineers can answer any product or application question, no matter the complexity.

Backing up this technical ability is a range of 50,000+ products available from stock for nationwide next day delivery (same day if required!), or you can collect what you need from any of our trade counters around the UK.

Select your specialist interest below to learn more about how we can help.

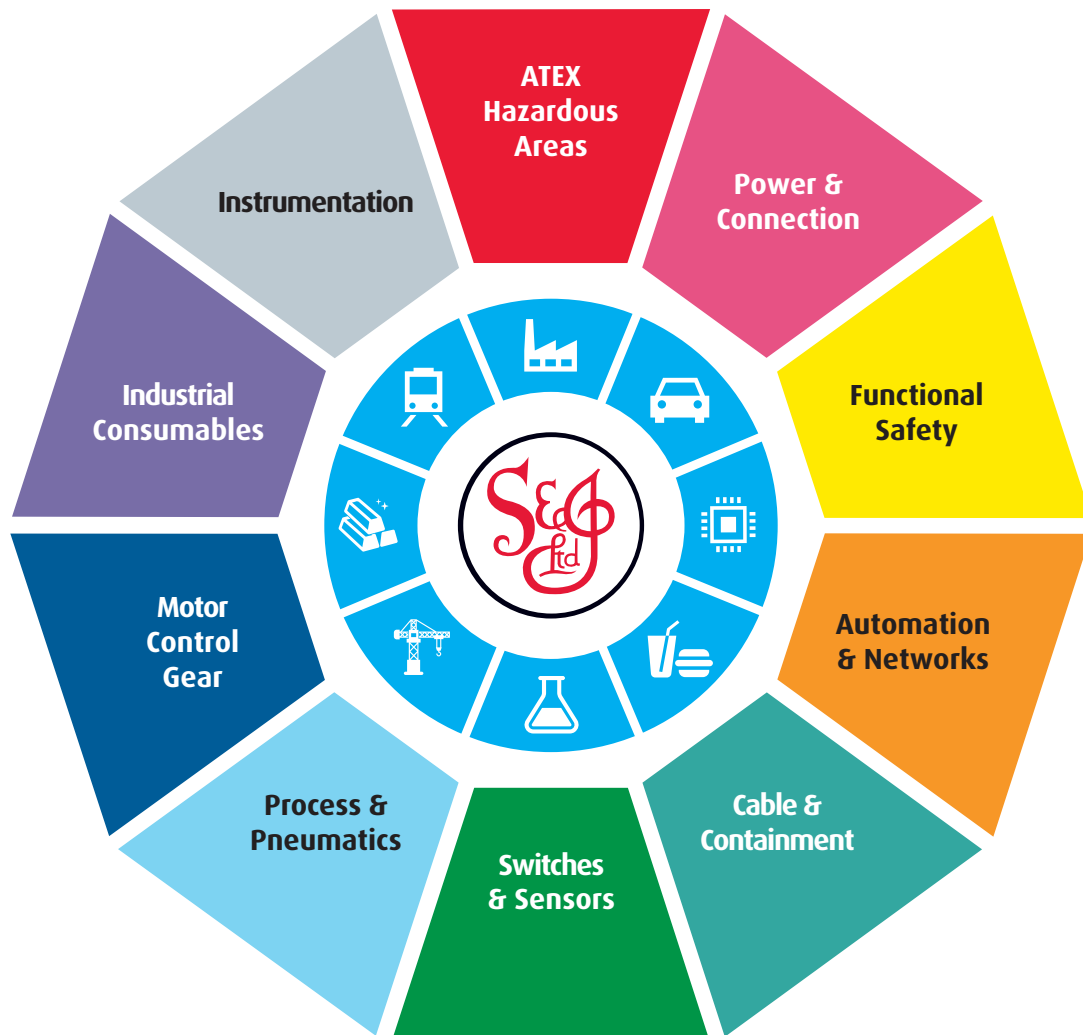

Online, In Branch and On the Road - Scattergood & Johnson Ltd, there when you need us.

www.scatts.co.uk