



Handbuch
Manual

eSIGN 24V

Funktionsbeschreibung der Signalsäule mit Konfigurationssoftware
Functional description of the signal tower with configuration software

Version: 2.0 - 06/2022

310.657.006



Deutsch	5
English	105

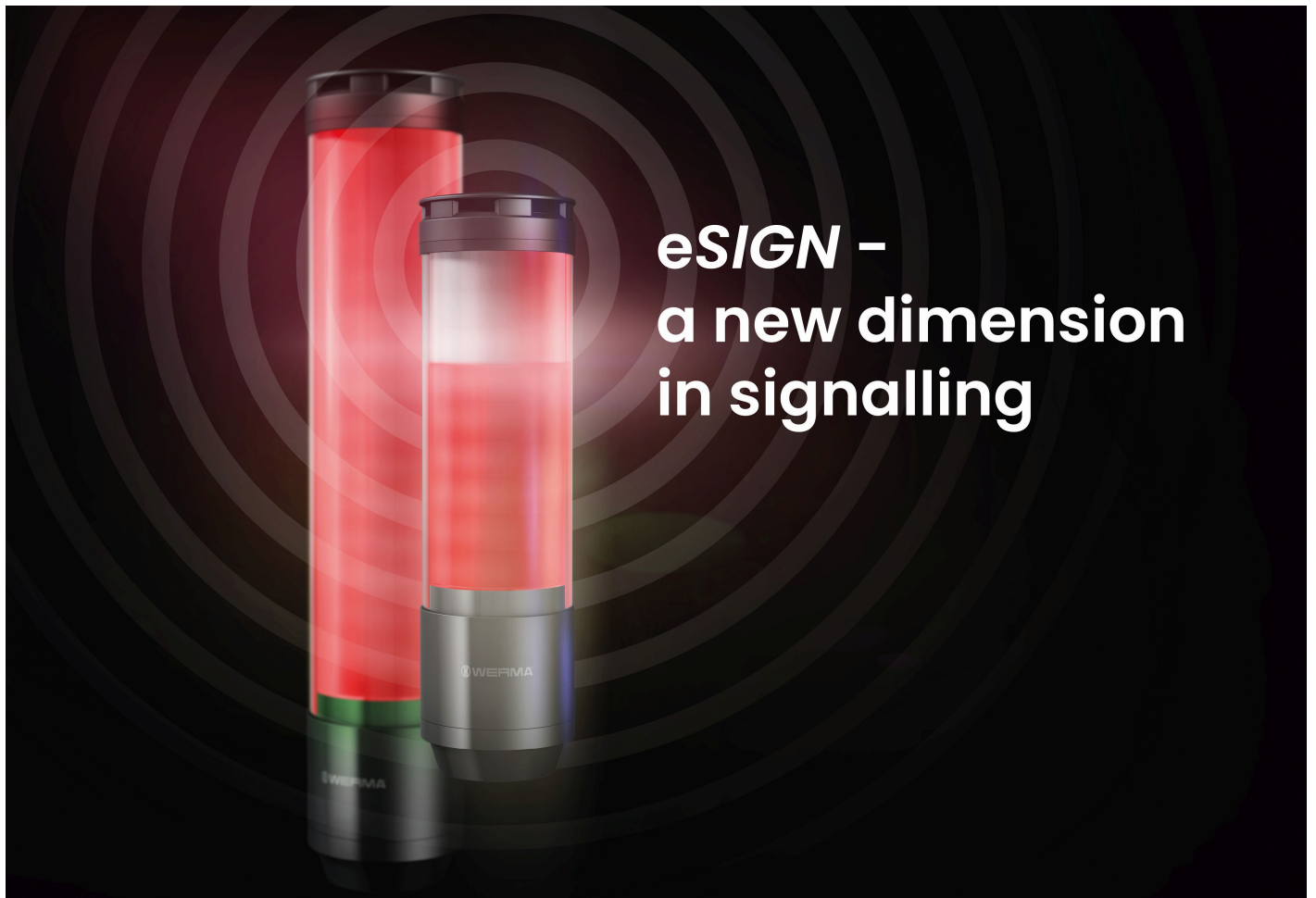

Handbuch **eSIGN 24V**

Funktionsbeschreibung der Signalsäule mit Konfigurationssoftware

Version: 2.0 - 06/2022

310.657.006

Impressum

Jegliche Erwähnung von Firmennamen dient ausschließlich zu Instruktionzwecken. Eine Bezugnahme auf tatsächlich existierende Organisationen ist, bis auf die unten stehenden Ausnahmen, nicht beabsichtigt. Folgende Firmen und Marken werden in der Hilfe genannt:

– Microsoft und Windows 10 sind Marken der Microsoft Corporation

Irrtum, Druckfehler und technische Änderungen vorbehalten.

© Copyright 2022, WERMA Signaltechnik GmbH + Co.KG.

Alle Rechte vorbehalten.

WERMA Signaltechnik GmbH + Co.KG

D-78604 Rietheim-Weilheim

Fon: +49 (0)7424 / 9557-222

Fax: +49 (0)7424 / 9557-44

support@werma.com

www.werma.com

Inhaltsverzeichnis

1	Überblick	9
1.1	Funktion	9
1.2	Hardware-Beschreibung	9
1.2.1	Übersicht Anschlussbereich	10
1.2.2	Übersicht M12-Stecker 8-polig	11
1.3	Systemanforderungen eSIGN-Konfigurationssoftware	11
2	eSIGN-Konfigurationssoftware installieren	12
3	eSIGN-Konfigurationssoftware starten	12
3.1	Überblick	13
3.1.1	Bereich Konfiguration	14
3.1.2	Bereich Geräteinformation	14
3.1.3	Bereich Support	14
3.1.4	Bereich Diese Software	14
3.1.5	Bereich Firmware	14
3.2	Sprache einstellen	14
4	Neue Konfiguration erstellen	15
4.1	Modus Autoscale	17
4.1.1	eSIGN-Variante wählen	18
4.1.2	Stufe hinzufügen oder entfernen	19
4.1.3	Stufe verschieben	19
4.1.4	Farbe wählen	20
4.1.5	Leuchteffekt wählen	21
4.1.6	Helligkeit einstellen	22
4.1.7	Sirene wählen	22
4.1.8	Pin wählen	24
4.1.9	Ansteuerung simulieren	25
4.1.10	Konfiguration abschließen	26
4.2	Modus Signalsäule	27
4.2.1	eSIGN-Variante wählen	28
4.2.2	Stufe hinzufügen oder entfernen	28
4.2.3	Stufe verschieben	29
4.2.4	Farbe wählen	29
4.2.5	Leuchteffekt wählen	31
4.2.6	Helligkeit einstellen	31
4.2.7	Sirene wählen	32
4.2.8	Pin wählen	34
4.2.9	Ansteuerung simulieren	35
4.2.10	Konfiguration abschließen	36

4.3	Modus Füllstand	37
4.3.1	eSIGN-Variante wählen	37
4.3.2	Anzahl der Signalkombinationen wählen	38
4.3.3	Farbe wählen	39
4.3.4	Füllstandanzeige konfigurieren	42
4.3.5	Ansteuerung simulieren	50
4.3.6	Konfiguration abschließen	50
4.4	Modus Individual	51
4.4.1	eSIGN-Variante wählen	51
4.4.2	Signalbilder konfigurieren	52
4.4.3	Pin wählen	60
4.4.4	Signalbild duplizieren	61
4.4.5	Signalbild hinzufügen	62
4.4.6	Signalbild löschen	62
4.4.7	Ansteuerung simulieren	62
4.4.8	Konfiguration abschließen	63
5	Konfiguration aus Beispielvorlagen übernehmen	64
6	Konfiguration von der angeschlossener eSIGN laden	66
7	Bestehende Konfiguration öffnen	67
8	eSIGN-Konfigurationssoftware aktualisieren	68
9	Firmware aktualisieren	69
10	Support	70
	Werma eSIGN - OSS-Lizenzvereinbarungen	71

1 Überblick

1.1 Funktion

Mit der neuen *eSIGN* bringen wir Licht in neue Dimensionen. Dank elektrischer Modularität lassen sich verschiedene Signalisierungsmodi mit mehreren Farben, Helligkeitsstufen und Leuchtbildern realisieren: Von der klassischen Ampel bis hin zu komplett kundenspezifischen Einstellungen. Auch variable Füllstandanzeigen oder vollflächige Signalisierungen sind mit *eSIGN* problemlos realisierbar. Das bringt nicht nur Übersicht in Ihre Prozessabläufe, sondern eröffnet ganz neue Möglichkeiten.

Mit Hilfe der WERMA *eSIGN*-Konfigurationssoftware können die einzelnen Segmente einer WERMA *eSIGN* konfiguriert und die Konfiguration auf die *eSIGN* übertragen werden.

Die Konfiguration kann mit oder ohne angeschlossener *eSIGN* durchgeführt werden. Falls keine *eSIGN* angeschlossen wird, kann die Konfiguration in einer Konfigurationsdatei gespeichert und zu einem späteren Zeitpunkt geladen und auf eine angeschlossene *eSIGN* übertragen werden.

1.2 Hardware-Beschreibung

Die Informationen zur Hardware gelten für folgende Artikelnummern:

- 657.000.55 - 9 Segmente
- 657.100.55 - 9 Segmente mit Sirene
- 657.500.55 - 15 Segmente
- 657.600.55 - 15 Segmente mit Sirene

1.2.1 Übersicht Anschlussbereich

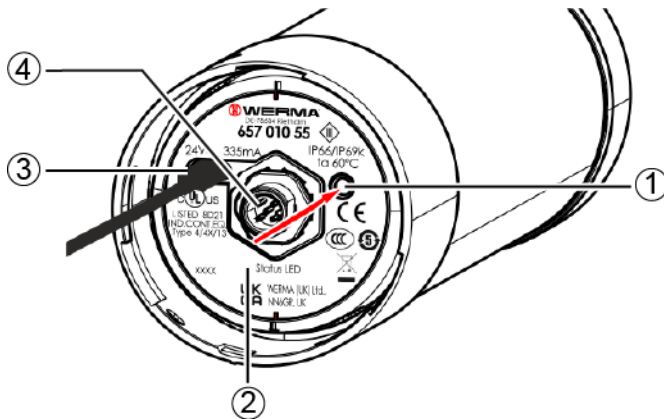

Pos.	Beschreibung
1	User-Button
2	Status-LED
3	USB-C-Anschluss
4	M12-Stecker 8-polig

LED-Status	Beschreibung
LED blinkt gelb	normaler Betrieb
LED pulsiert	Firmware-Update wird aufgespielt
LED ist aus	USB-C-Kabel nicht richtig verbunden

i Der User-Button ist in der aktuellen eSIGN-Version ohne Funktion und wird für zukünftige Funktionserweiterungen bereitgehalten.

1.2.2 Übersicht M12-Stecker 8-polig

Der Anschluss der eSIGN erfolgt über einen 8-poligen M12-Stecker mit folgender Belegung:

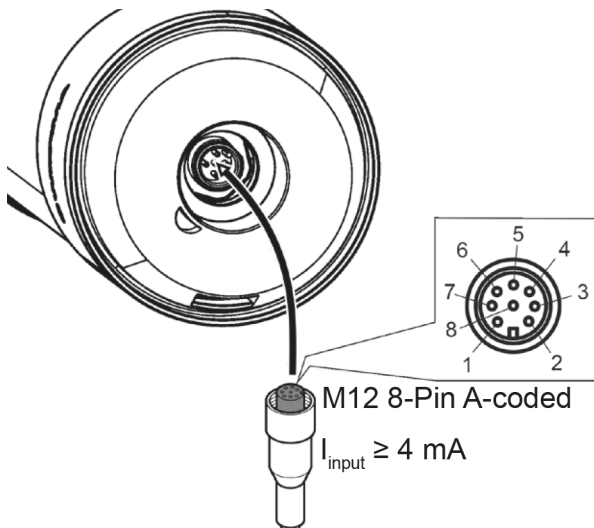

M12 Pinbelegung	Litzenfarbe M12- Kabel	Funktion
1	weiß	Signal 1
2	braun	Signal 2
3	grün	Signal 3
4	gelb	Signal 4
5	grau	Signal 5
6	rosa	Signal 6
7	blau	COM
8	rot	+24V

1.3 Systemanforderungen eSIGN-Konfigurationssoftware

Betriebssystem	Windows 10 x86/x64 Aktuelle Windows-Updates werden vorausgesetzt.
USB-Anschluss	Notwendig für die Hardware-Konfiguration.

i Unterstützte Betriebssysteme werden nur solange unterstützt, wie auch Microsoft diese über den Microsoft-Support Lifecycle unterstützt.

2 eSIGN-Konfigurationssoftware installieren

Die eSIGN-Konfigurationssoftware muss nicht installiert werden und ist als Portable lauffähig.

1. eSIGN-Konfigurationssoftware von folgender Webseite herunterladen: www.werma.com/software.

3 eSIGN-Konfigurationssoftware starten

1. Auf Werma-eSIGN-Konfigurator.exe doppelklicken.
→ Die eSIGN-Konfigurationssoftware startet.

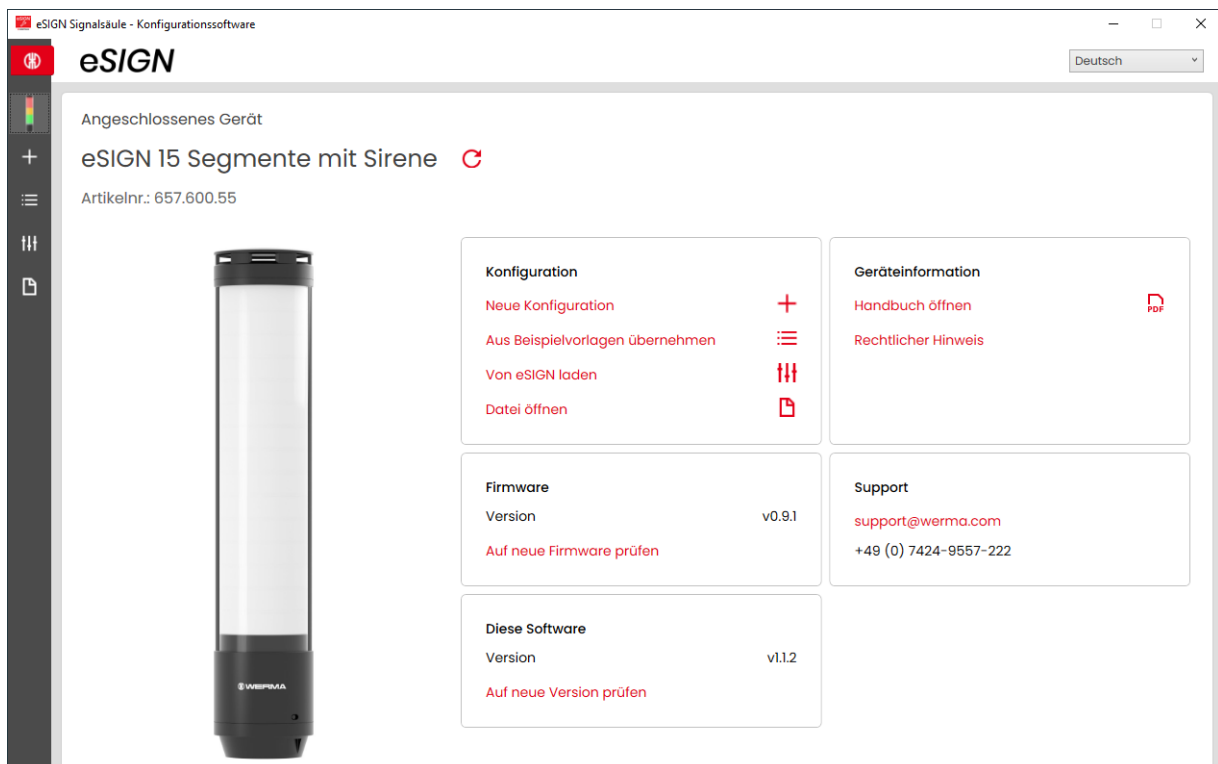

3.1 Überblick

DE

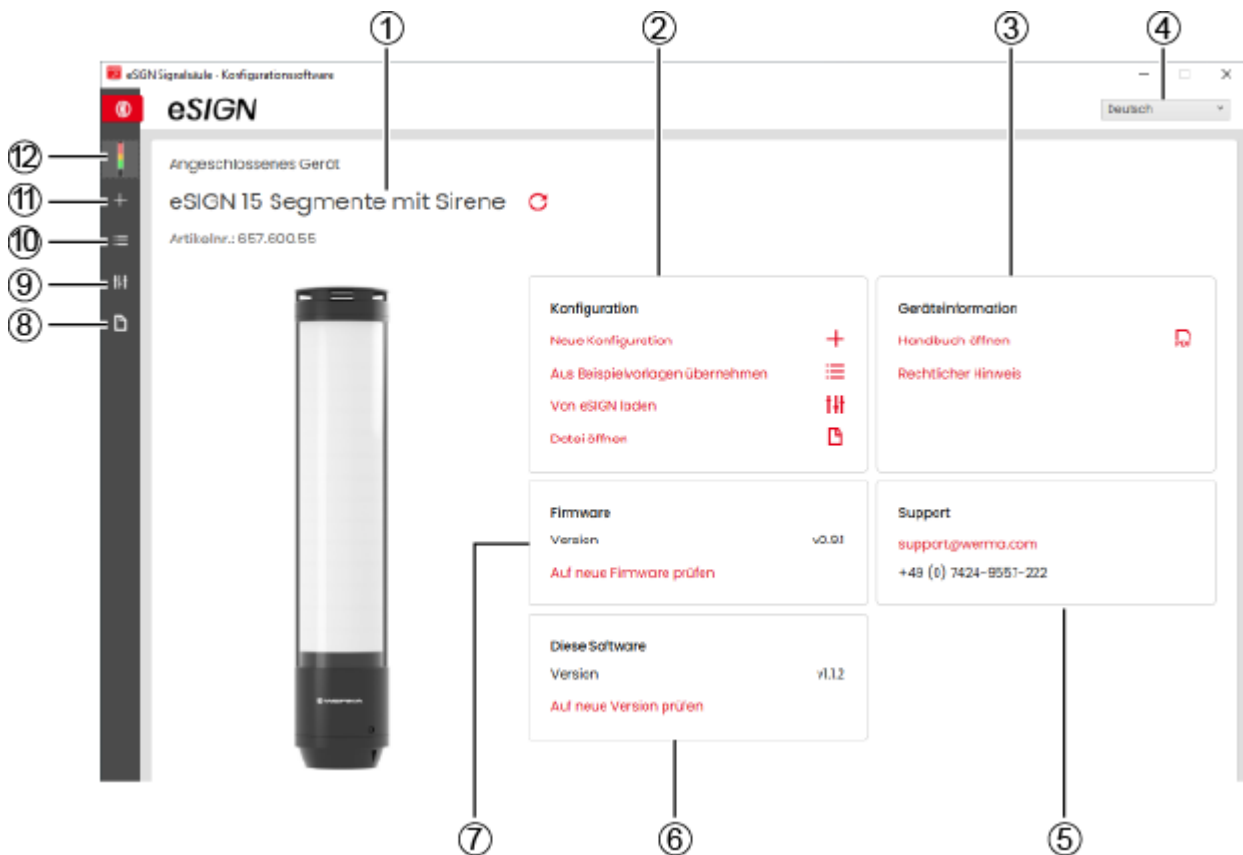

Pos.	Beschreibung
1	Variante der angeschlossenen eSIGN
2	Bereich Konfiguration
3	Bereich Geräteinformation
4	Sprache einstellen
5	Bereich Support
6	Bereich Diese Software
7	Bereich Firmware
8	Bestehende Konfiguration öffnen
9	Konfiguration von der eSIGN laden
10	Konfiguration aus Beispielvorgaben übernehmen
11	Neue Konfiguration erstellen
12	Startbildschirm aufrufen

3.1.1 Bereich Konfiguration

Im Bereich **Konfiguration** gibt es folgende Möglichkeiten, eine Konfiguration vorzunehmen:

- **Neue Konfiguration:** Eine neue Konfiguration erstellen (siehe "Neue Konfiguration erstellen", S. 15).
- **Aus Beispielvorlagen übernehmen:** Standard-Vorlagen öffnen, die sofort auf das Gerät überspielt werden können (siehe "Konfiguration aus Beispielvorlagen übernehmen", S. 64).
- **Von eSIGN laden:** Aktuelle Konfiguration (ggf. Auslieferungszustand) zur Bearbeitung öffnen (siehe "Konfiguration von der angeschlossener eSIGN laden", S. 66).
- **Datei öffnen:** Eine bestehende Konfiguration öffnen und wiederverwenden (siehe "Bestehende Konfiguration öffnen", S. 67).

3.1.2 Bereich Geräteinformation

Im Bereich **Geräteinformation** können das Handbuch und rechtliche Hinweise aufgerufen werden.

3.1.3 Bereich Support

Im Bereich **Support** werden die Kontaktinformationen des WERMA-Supports angezeigt.

3.1.4 Bereich Diese Software

Im Bereich **Diese Software** werden Informationen zur eSIGN Konfigurationssoftware angezeigt und eine Möglichkeit zur Aktualisierung der Konfigurationssoftware angeboten.

3.1.5 Bereich Firmware

Im Bereich **Firmware** werden Informationen zur Firmware der angeschlossenen eSIGN angezeigt und eine Möglichkeit zur Aktualisierung der Firmware angeboten.

3.2 Sprache einstellen

1. Im Auswahlm Menü die gewünschte Sprache wählen.

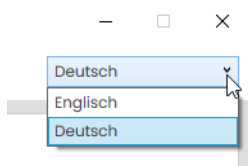

4 Neue Konfiguration erstellen

DE

 Die Konfiguration kann mit oder ohne angeschlossener eSIGN durchgeführt werden

 Die eSIGN kann gleichzeitig per USB-Kabel mit einem Computer und mit der 24V-Stromversorgung über das M12-Kabel verbunden werden.

1. eSIGN per USB-Kabel an Computer anschließen.

→ Die eSIGN-Konfigurationssoftware erkennt die angeschlossene eSIGN.

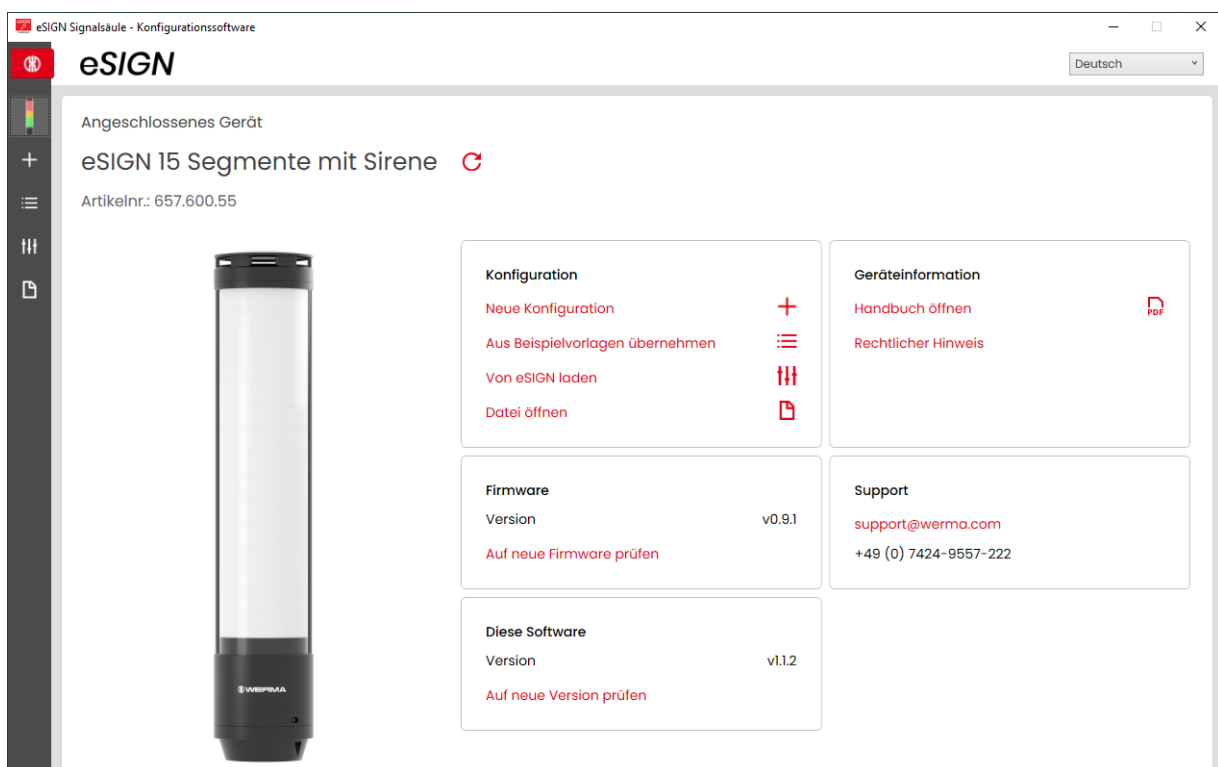

2. Falls die eSIGN-Konfigurationssoftware die angeschlossene eSIGN nicht erkennt: Auf **Angechlossenes Gerät aktualisieren** klicken.

kein Gerät verbunden



3. Im Bereich **Konfiguration** auf **Neue Konfiguration** klicken.

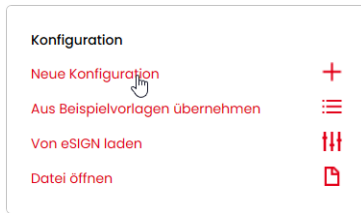

→ Der Bildschirm **Neue Konfiguration erstellen** erscheint.

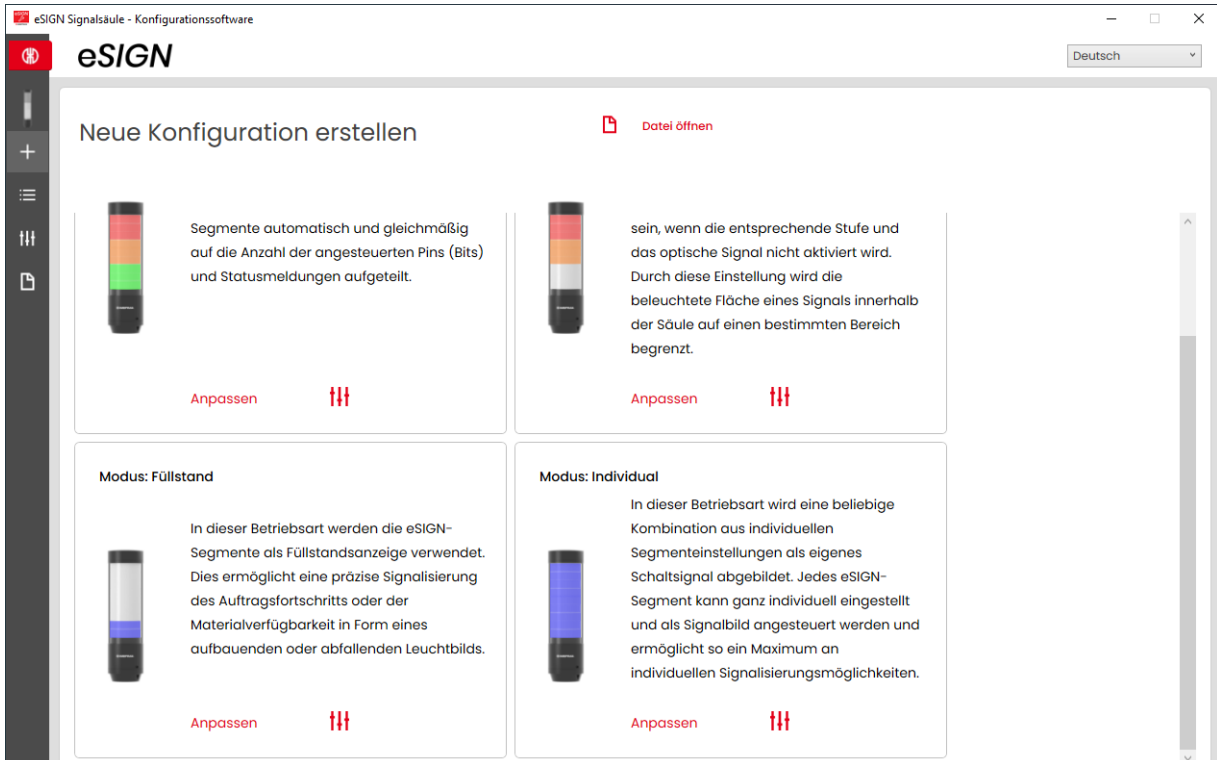

4. Je nach gewünschtem Konfigurationsmodus im Bereich **Autoscale, Signalsäule, Füllstand** oder **Individual** auf **Anpassen** klicken.

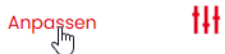

4.1 Modus Autoscale

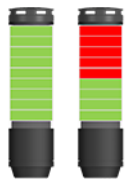

Die eSIGN-Segmente werden automatisch und gleichmäßig auf die Anzahl der angesteuerten Pins (Bits) und Statusmeldungen aufgeteilt.

Mit dieser Einstellung kann das volle Potenzial der eSIGN durch eine vollflächige Signalisierung ausgeschöpft werden. Ist z. B. nur eine Statusmeldung aktiv, wird die gesamte Fläche der eSIGN einfarbig beleuchtet, um eine maximale Sichtbarkeit zu gewährleisten.

Bei Anliegen von mehreren Signalen wird die beleuchtete Fläche anteilig aufgetrennt. Können die Segmente nicht gleichmäßig aufgeteilt werden, erhält die Farbe mit der höchsten Priorität (höchste Stelle innerhalb der Säule) das letzte Segment. Falls mehrere Segmente übrig sind, werden diese der Priorisierung nach (die Positionierung in der Säule von oben nach unten) gleichmäßig verteilt.

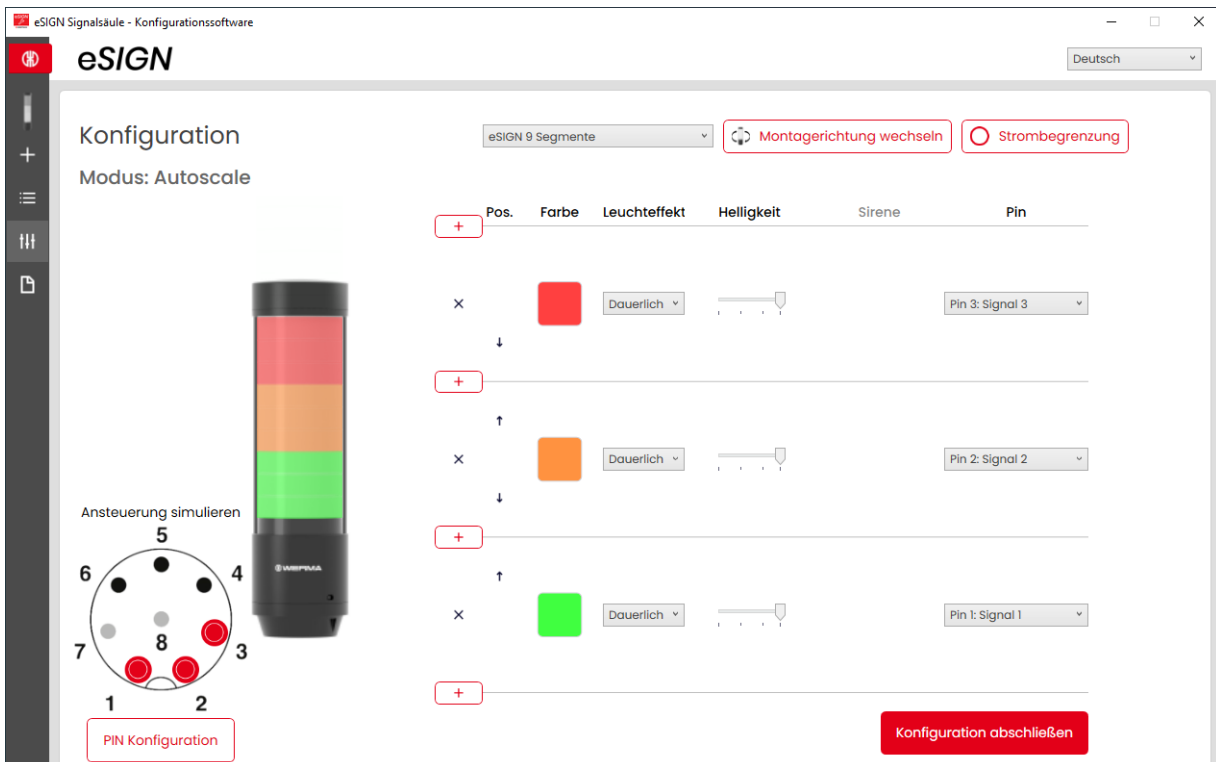

Pos.	Farbe	Leuchteffekt	Helligkeit	Sirene	Pin
x	Red	Dauerlich	Slider		Pin 3: Signal 3
+					
x	Orange	Dauerlich	Slider		Pin 2: Signal 2
+					
x	Green	Dauerlich	Slider		Pin 1: Signal 1
+					



Bei Bedarf kann die Ausrichtung der dargestellten Signalsäule über die Schaltfläche **Montagerichtung wechseln** um 180° gedreht werden.



Bei Bedarf (z. B. um die Strombegrenzungen von Steuerungsausgängen berücksichtigen zu können) kann über die Schaltfläche **Strombegrenzung** die Leistungsaufnahme der eSIGN verringert werden. In diesem Fall wird der Strombedarf der Säule auf unter 500 mA reduziert. Als Folge wird die Helligkeit der optischen Signale bzw. die Lautstärke der akustischen Signale verringert.

Der Modus **Autoscale** ist die Standard-Betriebsart bei Auslieferung und wie folgt eingestellt:

- Varianten mit 9 Segmenten:
 - 3 Stufen rot/gelb/grün
 - Dauerlicht
- Varianten mit 15 Segmenten:
 - 5 Stufen rot/gelb/grün/weiß/blau
 - Dauerlicht

Bei kundenindividuellen Versionen weicht der Auslieferungszustand von diesem Standard ab und ist gesondert dokumentiert.

4.1.1 eSIGN-Variante wählen

Falls eine eSIGN angeschlossen wurde, ist die Variante entsprechend vorausgewählt. Falls keine eSIGN angeschlossen wurde, kann die Variante der zu konfigurierenden eSIGN gewählt werden.

1. Bei Bedarf die Variante der zu konfigurierenden eSIGN wählen.

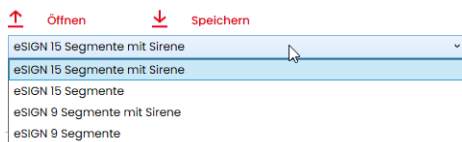

4.1.2 Stufe hinzufügen oder entfernen

Sobald im Modus **Autoscale** eine Stufe hinzugefügt oder entfernt wird, werden die einzelnen eSIGN-Segmente automatisch neu aufgeteilt und gleichmäßig auf alle Stufen verteilt. Falls die Segmente nicht gleichmäßig aufgeteilt werden können, erhält die Farbe mit der höchsten Priorität (höchste Stelle innerhalb der Säule) das letzte Segment. Falls mehrere Segmente übrig sind, werden diese der Priorisierung nach (die Positionierung in der Säule von oben nach unten) gleichmäßig verteilt.

Stufe hinzufügen

1. Auf **Hinzufügen** klicken.



×

→ Eine Stufe wurde hinzugefügt.

Stufe entfernen

1. Auf **Entfernen** klicken.



→ Eine Stufe wurde entfernt.

4.1.3 Stufe verschieben

Bei Bedarf können die einzelnen Stufen nach oben oder unten verschoben werden.

1. In der Spalte **Pos.** auf den Pfeil nach oben oder auf den Pfeil nach unten klicken, um die Stufe nach oben bzw. nach unten zu verschieben.



4.1.4 Farbe wählen

Jeder Stufe kann eine vorgegebene Standardfarbe oder eine individuelle Farbe zugewiesen werden.

1. In der Spalte **Farbe** auf das Farbfeld klicken.



→ Das Fenster **Farbe auswählen** erscheint.



2. Wählen, ob eine Standardfarbe oder eine individuelle Farbe verwendet werden soll.

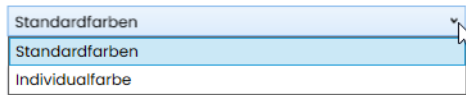

Standardfarbe

3. Auf das gewünschte Farbfeld klicken.



Folgende 8 Standardfarben stehen zur Auswahl zur Verfügung:

- rot
- gelb
- grün
- weiß
- blau
- hellgelb
- violett
- türkis

Individualfarbe

4. Gewünschte Farbe im Farbfeld auswählen oder den entsprechenden RGB-Wert in den Feldern **Rot**, **Grün** und **Blau** eingeben.

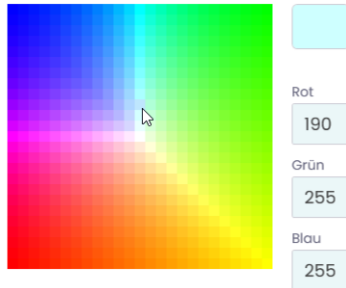

5. Auf **Farbe auswählen** klicken.



4.1.5 Leuchteffekt wählen

1. In der Spalte **Leuchteffekt** den gewünschten Leuchteffekt wählen.



Folgenden 8 Leuchteffekte stehen zur Auswahl zur Verfügung:

- Dauerlicht
- Blink 1Hz
- Blink 2 Hz
- Blink 3Hz
- Blitz 1x
- Blitz 2x
- Blitz 3x
- Rundum
- Ohne



Die Einstellung **Ohne** kann gewählt werden, falls die Stufe nur mit Sirene belegt werden soll.

4.1.6 Helligkeit einstellen

1. In der Spalte **Helligkeit** aus den 4 Optionen die gewünschte Helligkeit der Stufe einstellen.

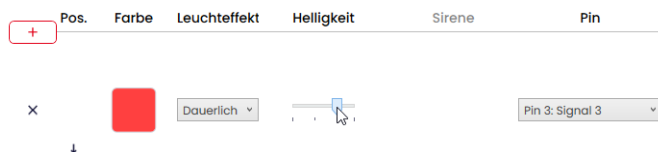

4.1.7 Sirene wählen

Falls die angeschlossene oder gewählte eSIGN eine Sirene hat, kann ein Signalton gewählt werden, der bei Aktivierung der Stufe ertönt.

i Falls Signaltöne für mehrere Stufen hinterlegt und die Stufen gleichzeitig angesteuert werden, ertönt die Sirene für die Farbe mit der höchsten Priorität (höchste Stelle innerhalb der Säule).

1. In der Spalte **Sirene** auf **Kein Ton** klicken.





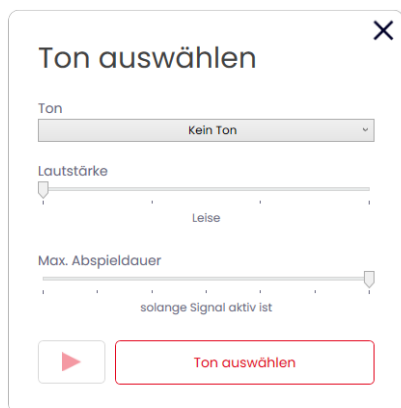





→ Das Fenster **Ton auswählen** erscheint.

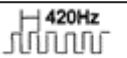
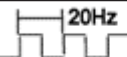

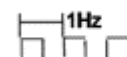
2. Den gewünschten **Ton**, die gewünschte **Lautstärke** und **Max. Abspieldauer** wählen.

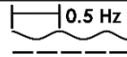
Folgenden 10 Tonarten stehen zur Auswahl zur Verfügung:

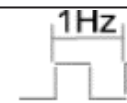
Ton	Frequenz	Beschreibung	Max. dB (A)
1	 2.7 kHz	Dauerton	104
2	 0.9 kHz	Dauerton	96
3	 2.8 kHz	Pulston	97
4	 0.9 kHz	Pulston	93
5	 2.8 kHz	Pulston	103
6	 0.9 kHz	Pulston	96
7	 2.8 kHz	Pulston	104
8	 2.3 kHz- 3.6 kHz	Wobbelton	104
9	 2.6 kHz	Dauerton	105
10	 1200 Hz 800 Hz	Wechselton	92



Die gewählten Einstellungen können über die Schaltfläche **Abspielen** (▶) getestet werden. Der wird dabei über den Computer abgespielt.

3. Auf **Ton auswählen** klicken.

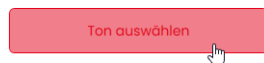

4.1.8 Pin wählen



Die Felder sind mit einer Standardbelegung vorkonfiguriert, von der unteren Stufe der Säule beginnend mit Pin 1.

Bereits verwendete Pins werden grau dargestellt. Die Belegung kann bei Bedarf beliebig verändert werden.

1. In der Spalte **Pin** den Pin des 8-poligen Steckers wählen, auf dem das Signal zum Auslösen der Stufe gesendet wird.

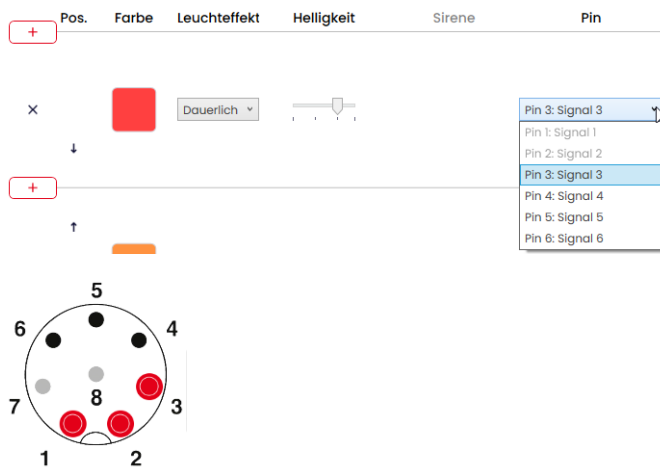

Pin-Konfiguration anpassen

Bei Bedarf kann die Zuordnung der Litzenfarbe zum Pin geändert und eine Beschreibung des Signals hinterlegt werden.

1. Unter der Pin-Übersicht auf **PIN Konfiguration** klicken.

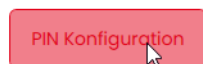

→ Das Fenster **PIN Konfiguration** erscheint.

PIN Konfiguration ✕

	Farbe	Beschreibung
Pin 1: Signal 1	<input type="text" value="WH"/>	<input type="text"/>
Pin 2: Signal 2	<input type="text" value="BN"/>	<input type="text"/>
Pin 3: Signal 3	<input type="text" value="GN"/>	<input type="text"/>
Pin 4: Signal 4	<input type="text" value="YE"/>	<input type="text"/>
Pin 5: Signal 5	<input type="text" value="GY"/>	<input type="text"/>
Pin 6: Signal 6	<input type="text" value="PK"/>	<input type="text"/>
Pin 7: COM	<input type="text" value="BU"/>	<input type="text"/>
Pin 8: +24V	<input type="text" value="RD"/>	<input type="text"/>

2. In der Spalte **Farbe** die gewünschte Litzenfarbe eingeben.
3. In der Spalte **Beschreibung** die Beschreibung des Signals eingeben.
4. Auf **Speichern** klicken.

4.1.9 Ansteuerung simulieren

Nachdem alle Einstellungen vorgenommen wurden, kann die Ansteuerung simuliert werden.

1. In der Pin-Übersicht auf den Pin klicken, der die gewünschte Stufe aktivieren soll.

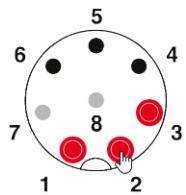

4.1.10 Konfiguration abschließen

1. Bei Bedarf weitere Änderungen an der Konfiguration vornehmen.
2. Sobald alle Stufen wie gewünscht konfiguriert sind, auf **Abschließen** klicken.
→ Das Fenster **Abschließen** erscheint.



3. Auf **Speichern** klicken, um die Konfiguration in einer Konfigurationsdatei zu speichern.
4. Auf **Auf Gerät übertragen** klicken, um die Konfiguration auf die angeschlossene eSIGN zu übertragen.
5. Auf **PDF-Konfigurationsblatt anzeigen** klicken, um eine Übersicht der aktuellen Konfiguration anzuzeigen.
6. Auf **PDF-Konfigurationsblatt speichern** klicken, um die Übersicht der aktuellen Konfiguration als PDF-Datei zu speichern.

4.2 Modus Signalsäule

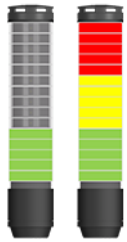

Einzelne eSIGN-Segmente können zu einer Stufe zusammengeschaltet werden. Dadurch kann eine klassische Signalsäule in elektronisch modularer Form realisiert werden. In diesem Modus haben die Stufen feste Positionen und können aus sein, wenn die entsprechende Stufe und das optische Signal nicht aktiviert wird.

Durch diese Einstellung wird die beleuchtete Fläche eines Signals innerhalb der Säule auf einen bestimmten Bereich begrenzt.

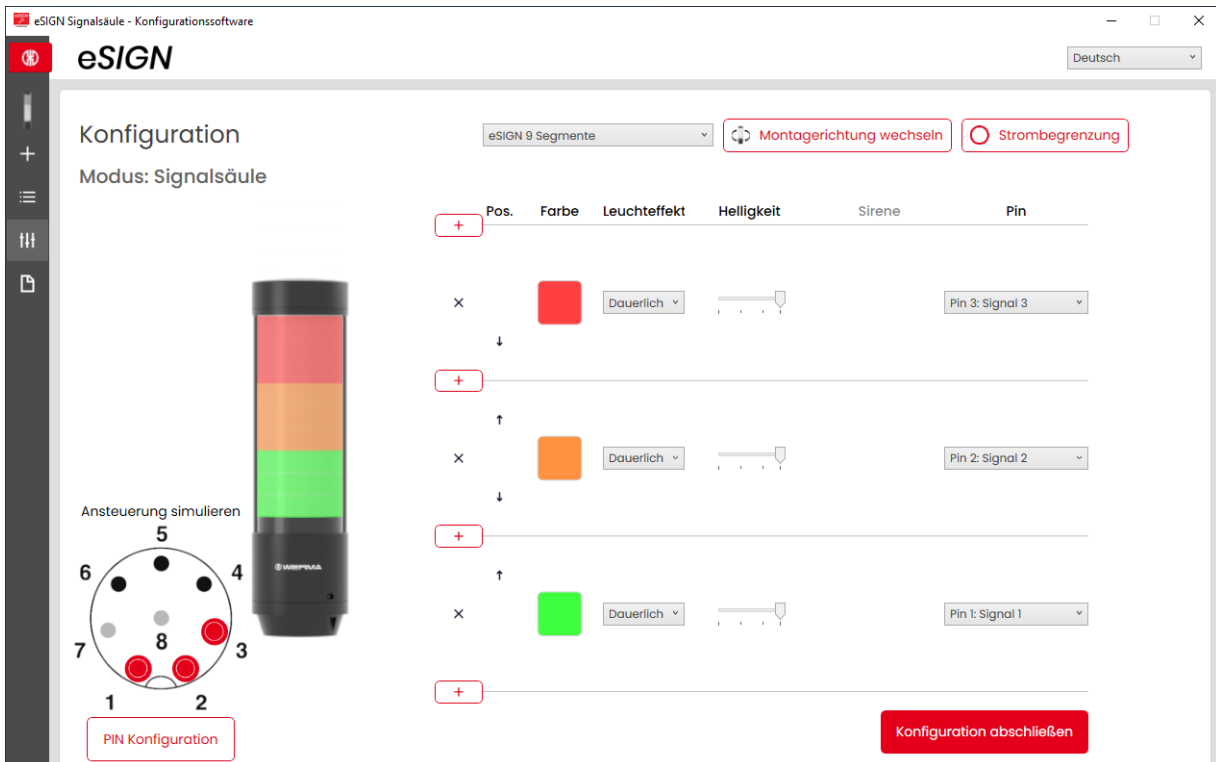

eSIGN Konfiguration

Modus: Signalsäule

eSIGN 9 Segmente Montagerichtung wechseln Strombegrenzung

Pos.	Farbe	Leuchteffekt	Helligkeit	Sirene	Pin
×	Red	Dauerlich	[Slider]		Pin 3: Signal 3
+	Orange	Dauerlich	[Slider]		Pin 2: Signal 2
×	Green	Dauerlich	[Slider]		Pin 1: Signal 1
+					

Ansteuerung simulieren

PIN Konfiguration

Konfiguration abschließen

i Bei Bedarf kann die Ausrichtung der dargestellten Signalsäule über die Schaltfläche **Montagerichtung wechseln** um 180° gedreht werden.

i Bei Bedarf (z. B. um die Strombegrenzungen von Steuerungsausgängen berücksichtigen zu können) kann über die Schaltfläche **Strombegrenzung** die Leistungsaufnahme der eSIGN verringert werden. In diesem Fall wird der Strombedarf der Säule auf unter 500 mA reduziert. Als Folge wird die Helligkeit der optischen Signale bzw. die Lautstärke der akustischen Signale verringert.

4.2.1 eSIGN-Variante wählen

Falls eine eSIGN angeschlossen wurde, ist die Variante entsprechend vorausgewählt. Falls keine eSIGN angeschlossen wurde, kann die Variante der zu konfigurierenden eSIGN gewählt werden.

1. Bei Bedarf die Variante der zu konfigurierenden eSIGN wählen.

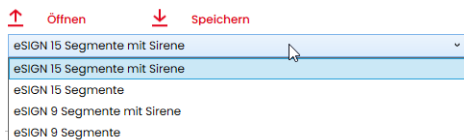

4.2.2 Stufe hinzufügen oder entfernen

Sobald im Modus **Signalsäule** eine Stufe hinzugefügt oder entfernt wird, werden die einzelnen eSIGN-Segmente automatisch neu aufgeteilt und gleichmäßig auf alle Stufen verteilt.

Stufe hinzufügen

1. Auf **Hinzufügen** klicken.



×

→ Eine Stufe wurde hinzugefügt.

Stufe entfernen

1. Auf **Entfernen** klicken.



→ Eine Stufe wurde entfernt.

4.2.3 Stufe verschieben

Bei Bedarf können die einzelnen Stufen nach oben oder unten verschoben werden.

1. In der Spalte **Pos.** auf den Pfeil nach oben oder auf den Pfeil nach unten klicken, um die Stufe nach oben bzw. nach unten zu verschieben.



4.2.4 Farbe wählen

Jeder Stufe kann eine vorgegebene Standardfarbe oder eine individuelle Farbe zugewiesen werden.

1. In der Spalte **Farbe** auf das Farbfeld klicken.



→ Das Fenster **Farbe auswählen** erscheint.



2. Wählen, ob eine Standardfarbe oder eine individuelle Farbe verwendet werden soll.

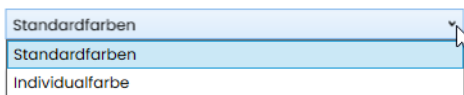

Standardfarbe

3. Auf das gewünschte Farbfeld klicken.



Folgende 8 Standardfarben stehen zur Auswahl zur Verfügung:

- rot
- gelb
- grün
- weiß
- blau
- hellgelb
- violett
- türkis

Individualfarbe

4. Gewünschte Farbe im Farbfeld auswählen oder den entsprechenden RGB-Wert in den Feldern **Rot**, **Grün** und **Blau** eingeben.

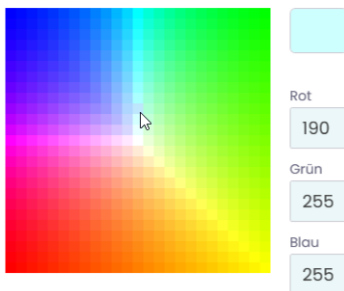

5. Auf **Farbe auswählen** klicken.

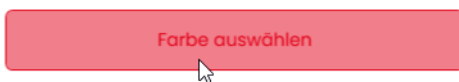

4.2.5 Leuchteffekt wählen

1. In der Spalte **Leuchteffekt** den gewünschten Leuchteffekt wählen.



Folgenden 8 Leuchteffekte stehen zur Auswahl zur Verfügung:

- Dauerlicht
- Blink 1Hz
- Blink 2 Hz
- Blink 3Hz
- Blitz 1x
- Blitz 2x
- Blitz 3x
- Rundum
- Ohne



Die Einstellung **Ohne** kann gewählt werden, falls die Stufe nur mit Sirene belegt werden soll.

4.2.6 Helligkeit einstellen

1. In der Spalte **Helligkeit** aus den 4 Optionen die gewünschte Helligkeit der Stufe einstellen.

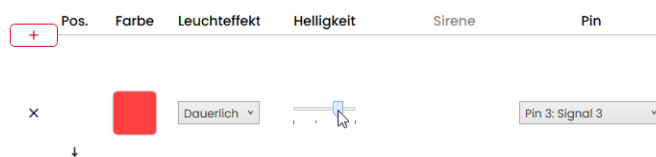

4.2.7 Sirene wählen

Falls die angeschlossene oder gewählte eSIGN eine Sirene hat, kann ein Signalton gewählt werden, der bei Aktivierung der Stufe ertönt.

- i** Falls Signaltöne für mehrere Stufen hinterlegt und die Stufen gleichzeitig angesteuert werden, ertönt die Sirene für die Farbe mit der höchsten Priorität (höchste Stelle innerhalb der Säule).

1. In der Spalte **Sirene** auf **Kein Ton** klicken.



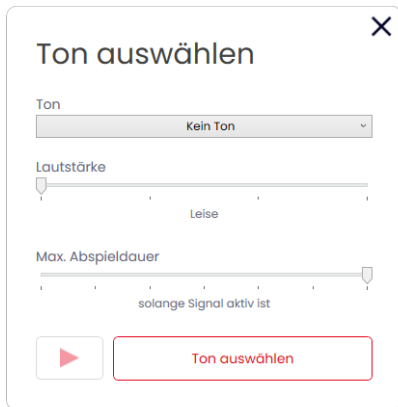

→ Das Fenster **Ton auswählen** erscheint.

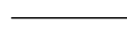
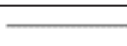
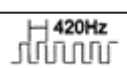
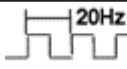
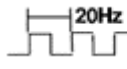
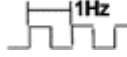

2. Den gewünschten **Ton**, die gewünschte **Lautstärke** und **Max. Abspieldauer** wählen.

Folgenden 10 Tonarten stehen zur Auswahl zur Verfügung:

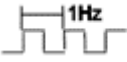
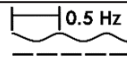
Ton	Frequenz	Beschreibung	Max. dB (A)
1	 2.7 kHz	Dauerton	104
2	 0.9 kHz	Dauerton	96
3	 420Hz 2.8 kHz	Pulston	97
4	 20Hz 0.9 kHz	Pulston	93
5	 20Hz 2.8 kHz	Pulston	103
6	 1Hz 0.9 kHz	Pulston	96

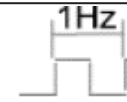
Ton	Frequenz	Beschreibung	Max. dB (A)
7	 2.8 kHz	Pulston	104
8	 2.3 kHz- 3.6 kHz	Wobbelton	104
9	 2.6 kHz	Dauerton	105
10	 1200 Hz 800 Hz	Wechselton	92

 Die gewählten Einstellungen können über die Schaltfläche **Abspielen** (▶) getestet werden. Der wird dabei über den Computer abgespielt.

3. Auf **Ton auswählen** klicken.

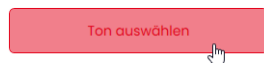

4.2.8 Pin wählen



Die Felder sind mit einer Standardbelegung vorkonfiguriert, von der unteren Stufe der Säule beginnend mit Pin 1.

Bereits verwendete Pins werden grau dargestellt. Die Belegung kann bei Bedarf beliebig verändert werden.

1. In der Spalte **Pin** den Pin des 8-poligen Steckers wählen, auf dem das Signal zum Auslösen der Stufe gesendet wird.

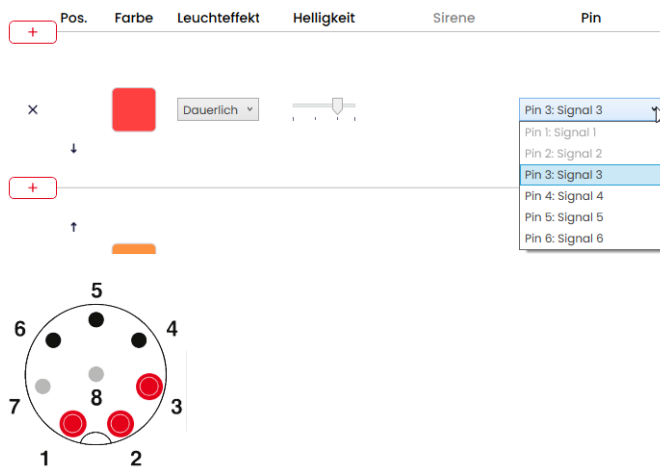

Pin-Konfiguration anpassen

Bei Bedarf kann die Zuordnung der Litzenfarbe zum Pin geändert und eine Beschreibung des Signals hinterlegt werden.

1. Unter der Pin-Übersicht auf **PIN Konfiguration** klicken.

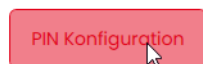

→ Das Fenster **PIN Konfiguration** erscheint.

PIN Konfiguration ✕

	Farbe	Beschreibung
Pin 1: Signal 1	<input type="text" value="WH"/>	<input type="text"/>
Pin 2: Signal 2	<input type="text" value="BN"/>	<input type="text"/>
Pin 3: Signal 3	<input type="text" value="GN"/>	<input type="text"/>
Pin 4: Signal 4	<input type="text" value="YE"/>	<input type="text"/>
Pin 5: Signal 5	<input type="text" value="GY"/>	<input type="text"/>
Pin 6: Signal 6	<input type="text" value="PK"/>	<input type="text"/>
Pin 7: COM	<input type="text" value="BU"/>	<input type="text"/>
Pin 8: +24V	<input type="text" value="RD"/>	<input type="text"/>

2. In der Spalte **Farbe** die gewünschte Litzenfarbe eingeben.
3. In der Spalte **Beschreibung** die Beschreibung des Signals eingeben.
4. Auf **Speichern** klicken.

4.2.9 Ansteuerung simulieren

Nachdem alle Einstellungen vorgenommen wurden, kann die Ansteuerung simuliert werden.

1. In der Pin-Übersicht auf den Pin klicken, der die gewünschte Stufe aktivieren soll.

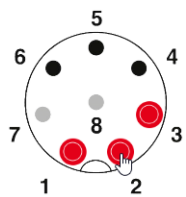

4.2.10 Konfiguration abschließen

1. Bei Bedarf weitere Änderungen an der Konfiguration vornehmen.
2. Sobald alle Stufen wie gewünscht konfiguriert sind, auf **Abschließen** klicken.
→ Das Fenster **Abschließen** erscheint.



3. Auf **Speichern** klicken, um die Konfiguration in einer Konfigurationsdatei zu speichern.
4. Auf **Auf Gerät übertragen** klicken, um die Konfiguration auf die angeschlossene eSIGN zu übertragen.
5. Auf **PDF-Konfigurationsblatt anzeigen** klicken, um eine Übersicht der aktuellen Konfiguration anzuzeigen.
6. Auf **PDF-Konfigurationsblatt speichern** klicken, um die Übersicht der aktuellen Konfiguration als PDF-Datei zu speichern.

4.3 Modus Füllstand

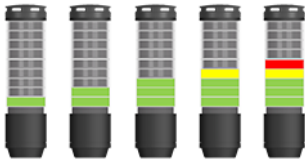

In dieser Betriebsart werden die eSIGN-Segmente als Füllstandanzeige verwendet. Dies ermöglicht eine präzise Signalisierung des Auftragsfortschritts oder der Materialverfügbarkeit in Maschinenprozessen in Form eines aufbauenden oder abfallenden Leuchtbilds.

Modus: Füllstand ✕

Gerät: eSIGN 15 Segmente mit Sirene Farben: Einzelfarbe

Anzahl der Signalkombinationen: 15

= Anzahl zugeordneter Segmente: 15
= Anzahl nicht zugeordneter Segmente: 0

Aufteilung nicht zugeordnete Segmente: Top (Füllend)

Konfiguration erstellen

4.3.1 eSIGN-Variante wählen

Falls eine eSIGN angeschlossen wurde, ist die Variante entsprechend vorausgewählt. Falls keine eSIGN angeschlossen wurde, kann die Variante der zu konfigurierenden eSIGN gewählt werden.

1. Bei Bedarf im Feld **Gerät** die Variante der eSIGN wählen.

Gerät

eSIGN 15 Segmente mit Sirene ▼

eSIGN 15 Segmente mit Sirene

eSIGN 15 Segmente

eSIGN 9 Segmente mit Sirene

eSIGN 9 Segmente

4.3.2 Anzahl der Signalkombinationen wählen

1. Im Bereich **Anzahl der Signalkombinationen** wählen, wie viele eSIGN-Segmente für die Füllstandanzeige verwendet werden sollen.

Falls nicht alle eSIGN-Segmente für die Füllstandanzeige verwendet werden:

2. Im Feld **Aufteilung nicht zugeordnete Segmente** wählen, wie die eSIGN-Segmente angezeigt werden, die nicht für die Füllstandanzeige verwendet werden sollen.

Einstellung	Beschreibung
Top (Füllend)	Nicht zugeordnete eSIGN-Segmente werden oben angeordnet und mit der obersten Stufe geschaltet.
Unten (Füllend)	Nicht zugeordnete eSIGN-Segmente werden unten angeordnet und mit der untersten Stufe geschaltet.
Top (Aus)	Nicht zugeordnete eSIGN-Segmente werden oben angeordnet und sind immer aus.
Unten (Aus)	Nicht zugeordnete eSIGN-Segmente werden unten angeordnet und sind immer aus.

4.3.3 Farbe wählen

Für die Anzeige des Füllstands kann eine einheitliche Farbe oder ein Farbverlauf gewählt werden. Bei einem Farbverlauf wird der Verlauf der Farbtöne zwischen den beiden Farben automatisch berechnet.

Bei Bedarf kann die Farbe jedes einzelnen Segments der Füllstandanzeige zu einem späteren Zeitpunkt angepasst werden.

1. Im Feld **Farben** wählen, ob der Füllstand in einer einheitlicher Farbe oder als Farbverlauf dargestellt werden soll.

Einzelfarbe

2. Auf das Farbfeld klicken, um die gewünschte Farbe zu wählen.
→ Das Fenster **Farbe auswählen** erscheint.



3. Wählen, ob eine Standardfarbe oder eine individuelle Farbe verwendet werden soll.

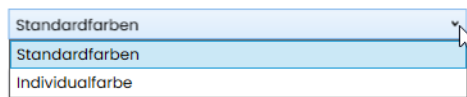

Standardfarbe

4. Auf das gewünschte Farbfeld klicken.



Folgende 8 Standardfarben stehen zur Auswahl zur Verfügung:

- rot
- gelb
- grün
- weiß
- blau
- hellgelb
- violett
- türkis

Individualfarbe

5. Gewünschte Farbe im Farbfeld auswählen oder den entsprechenden RGB-Wert in den Feldern **Rot**, **Grün** und **Blau** eingeben.

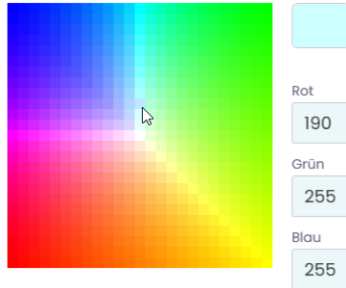

6. Auf **Farbe auswählen** klicken.



7. Auf **Konfiguration erstellen** klicken.
→ Der Bildschirm **Konfiguration** erscheint.

Farbverlauf

8. Auf die Farbfelder für die Start- und die Endfarbe des Farbverlaufs klicken.
→ Das Fenster **Farbe auswählen** erscheint.



9. Wählen, ob eine Standardfarbe oder eine individuelle Farbe verwendet werden soll.

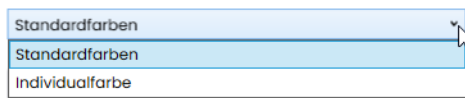

Standardfarbe

10. Auf das gewünschte Farbfeld klicken.



Individualfarbe

11. Gewünschte Farbe im Farbfeld auswählen oder den entsprechenden RGB-Wert eingeben in den Felder **Rot**, **Grün** und **Blau** eingeben.

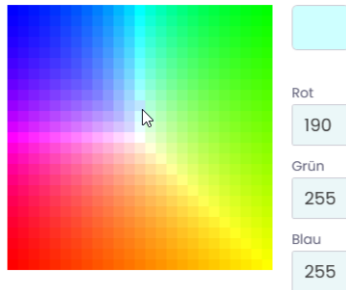

12. Auf **Farbe auswählen** klicken.

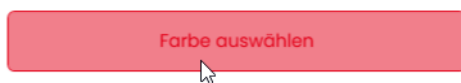

13. Auf **Konfiguration erstellen** klicken.
→ Der Bildschirm **Konfiguration** erscheint.

Segmente entfernen oder hinzufügen

Segment entfernen

1. Auf **Entfernen** klicken.

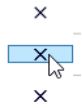

→ Das Segment wurde entfernt.

Segment hinzufügen

1. Auf **Hinzufügen** klicken.

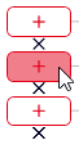

→ Das Segment wurde hinzugefügt.

Segmente verschieben

Bei Bedarf können die einzelnen Segmente nach oben oder unten verschoben werden.

1. In der Spalte **Pos.** auf den Pfeil nach oben oder auf den Pfeil nach unten klicken, um das Segment nach oben bzw. nach unten zu verschieben.

	Pos.	Farbe	Leuchteffekt	Helligkeit	Sirene	Pin		
x	↓		Dauerlich ▾		Kein Ton	6	1	
x	↑		Dauerlich ▾		Kein Ton	6	1	

Farbe wählen

Für jedes einzelne Segment kann bei Bedarf eine vorgegebene Standardfarbe gewählt oder eine individuelle Farbe zugewiesen werden.

1. In der Spalte **Farbe** auf das Farbfeld klicken.

Pos.	Farbe	Leuchteffekt	Helligkeit	Sirene	Pin
x		Dauerlich		Kein Ton	6 <input type="checkbox"/> <input type="checkbox"/> <input checked="" type="checkbox"/> <input checked="" type="checkbox"/> <input checked="" type="checkbox"/> 1
x		Dauerlich		Kein Ton	6 <input type="checkbox"/> <input type="checkbox"/> <input checked="" type="checkbox"/> <input checked="" type="checkbox"/> <input type="checkbox"/> 1

→ Das Fenster **Farbe auswählen** erscheint.

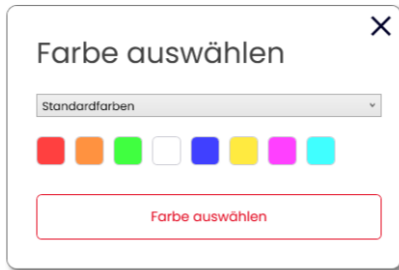

2. Wählen, ob eine Standardfarbe oder eine individuelle Farbe verwendet werden soll.

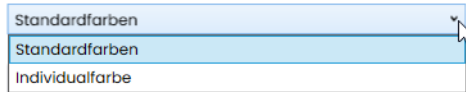

Standardfarbe

3. Auf das gewünschte Farbfeld klicken.



Folgende 8 Standardfarben stehen zur Auswahl zur Verfügung:

- rot
- gelb
- grün
- weiß
- blau
- hellgelb
- violett
- türkis

Individualfarbe

4. Gewünschte Farbe im Farbfeld auswählen oder den entsprechenden RGB-Wert in den Feldern **Rot**, **Grün** und **Blau** eingeben.

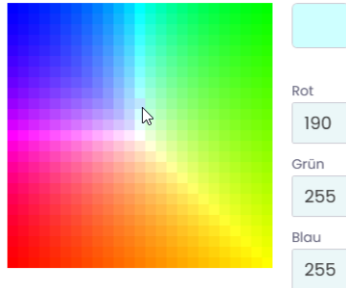

5. Auf **Farbe auswählen** klicken.

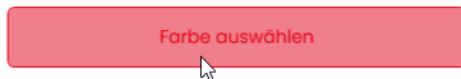

Leuchteffekt wählen

1. In der Spalte **Leuchteffekt** den gewünschten Leuchteffekt wählen.

Pos.	Farbe	Leuchteffekt	Helligkeit	Sirene	Pin
x	↓	Dauerlich	—	Kein Ton	6 <input type="checkbox"/> 1 <input checked="" type="checkbox"/>
x	↓	Dauerlicht	—	Kein Ton	6 <input type="checkbox"/> 1 <input checked="" type="checkbox"/>
x	↓	Blink: 1Hz	—	Kein Ton	6 <input type="checkbox"/> 1 <input checked="" type="checkbox"/>
x	↓	Blink: 2Hz	—	Kein Ton	6 <input type="checkbox"/> 1 <input checked="" type="checkbox"/>
x	↓	Blink: 3Hz	—	Kein Ton	6 <input type="checkbox"/> 1 <input checked="" type="checkbox"/>
x	↓	Blitz: 1x	—	Kein Ton	6 <input type="checkbox"/> 1 <input checked="" type="checkbox"/>
x	↓	Blitz: 2x	—	Kein Ton	6 <input type="checkbox"/> 1 <input checked="" type="checkbox"/>
x	↓	Blitz: 3x	—	Kein Ton	6 <input type="checkbox"/> 1 <input checked="" type="checkbox"/>
x	↓	Rundum	—	Kein Ton	6 <input type="checkbox"/> 1 <input checked="" type="checkbox"/>
x	↓	Ohne	—	Kein Ton	6 <input type="checkbox"/> 1 <input checked="" type="checkbox"/>

Folgenden 8 Leuchteffekte stehen zur Auswahl zur Verfügung:

- Dauerlicht
- Blink 1Hz
- Blink 2Hz
- Blink 3Hz
- Blitz 1x
- Blitz 2x
- Blitz 3x
- Rundum
- Ohne



Die Einstellung **Ohne** kann gewählt werden, falls die Stufe nur mit Sirene belegt werden soll.

Helligkeit einstellen

1. In der Spalte **Helligkeit** aus den 4 Optionen die gewünschte Helligkeit der Stufe einstellen.



Sirene wählen

Falls die angeschlossene oder gewählte eSIGN eine Sirene hat, kann ein Signalton gewählt werden, der bei Aktivierung des Segments ertönt.

i Falls Signaltöne für mehrere Stufen hinterlegt und die Stufen gleichzeitig angesteuert werden, ertönt die Sirene für die Farbe mit der höchsten Priorität (höchste Stelle innerhalb der Säule).

1. In der Spalte **Sirene** auf **Kein Ton** klicken.





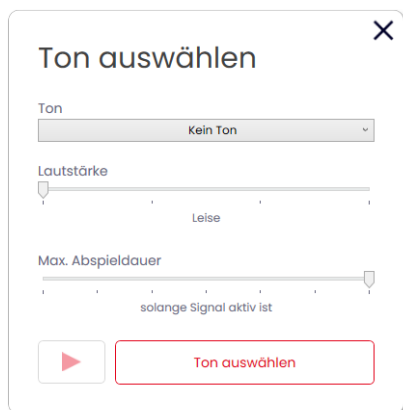

→ Das Fenster **Ton auswählen** erscheint.

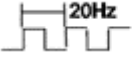
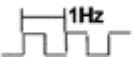

2. Den gewünschten **Ton**, die gewünschte **Lautstärke** und **Max. Abspieldauer** wählen.

Folgenden 10 Tonarten stehen zur Auswahl zur Verfügung:

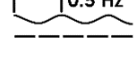
Ton	Frequenz	Beschreibung	Max. dB (A)
1	2.7 kHz	Dauerton	104
2	0.9 kHz	Dauerton	96
3	420Hz 2.8 kHz	Pulston	97
4	20Hz 0.9 kHz	Pulston	93

Ton	Frequenz	Beschreibung	Max. dB (A)
5	 2.8 kHz	Pulston	103
6	 0.9 kHz	Pulston	96
7	 2.8 kHz	Pulston	104
8	 2.3 kHz- 3.6 kHz	Wobbelton	104
9	 2.6 kHz	Dauerton	105
10	 1200 Hz 800 Hz	Wechselton	92

 Die gewählten Einstellungen können über die Schaltfläche **Abspielen** (▶) getestet werden. Der wird dabei über den Computer abgespielt.

3. Auf **Ton auswählen** klicken.

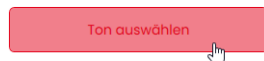

Pin wählen

i Die Felder sind mit einer Standardbelegung vorkonfiguriert, von der unteren Stufe der Säule beginnend mit Pin 1.

Bereits verwendete Pins werden grau dargestellt. Die Belegung kann bei Bedarf beliebig verändert werden.

Die Ansteuerung der Füllstandanzeige erfolgt über eine Bit-Codierung. Die Kontrollkästchen in der Spalte **Pin** entsprechen den 6 Pins bzw. Signalleitungen. Das Setzen eines Hakens in einem oder mehreren Kontrollkästchen zeigt an, dass diese Pins bzw. Signalleitungen angesteuert werden müssen, um die entsprechende Einstellung zu aktivieren.

Beispiel:

Für die Darstellung der kompletten Säule in grün müssen die Pins 1-4 angesteuert werden.

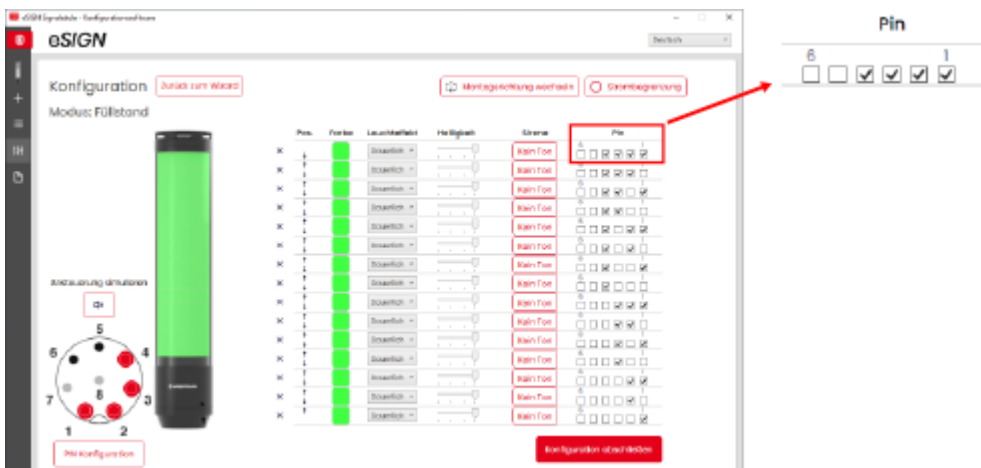

1. In der Spalte **Pin** die Pins des 8-poligen Steckers wählen, auf dem das Signal zum Auslösen der Stufe gesendet wird.

Pos.	Farbe	Leuchteffekt	Helligkeit	Sirene	Pin										
x	↓		Dauerlich	Kein Ton	<table border="0"> <tr> <td>8</td><td><input type="checkbox"/></td> <td>6</td><td><input checked="" type="checkbox"/></td> <td>4</td><td><input checked="" type="checkbox"/></td> <td>2</td><td><input checked="" type="checkbox"/></td> <td>1</td><td><input checked="" type="checkbox"/></td> </tr> </table>	8	<input type="checkbox"/>	6	<input checked="" type="checkbox"/>	4	<input checked="" type="checkbox"/>	2	<input checked="" type="checkbox"/>	1	<input checked="" type="checkbox"/>
8	<input type="checkbox"/>	6	<input checked="" type="checkbox"/>	4	<input checked="" type="checkbox"/>	2	<input checked="" type="checkbox"/>	1	<input checked="" type="checkbox"/>						
x	↑		Dauerlich	Kein Ton	<table border="0"> <tr> <td>8</td><td><input type="checkbox"/></td> <td>6</td><td><input checked="" type="checkbox"/></td> <td>4</td><td><input checked="" type="checkbox"/></td> <td>2</td><td><input checked="" type="checkbox"/></td> <td>1</td><td><input type="checkbox"/></td> </tr> </table>	8	<input type="checkbox"/>	6	<input checked="" type="checkbox"/>	4	<input checked="" type="checkbox"/>	2	<input checked="" type="checkbox"/>	1	<input type="checkbox"/>
8	<input type="checkbox"/>	6	<input checked="" type="checkbox"/>	4	<input checked="" type="checkbox"/>	2	<input checked="" type="checkbox"/>	1	<input type="checkbox"/>						

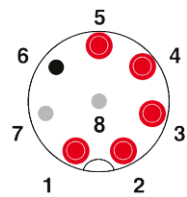

Pin-Konfiguration anpassen

Bei Bedarf kann die Zuordnung der Litzenfarbe zum Pin geändert und eine Beschreibung des Signals hinterlegt werden.

1. Unter der Pin-Übersicht auf **PIN Konfiguration** klicken.

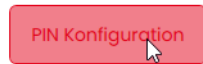

→ Das Fenster **PIN Konfiguration** erscheint.

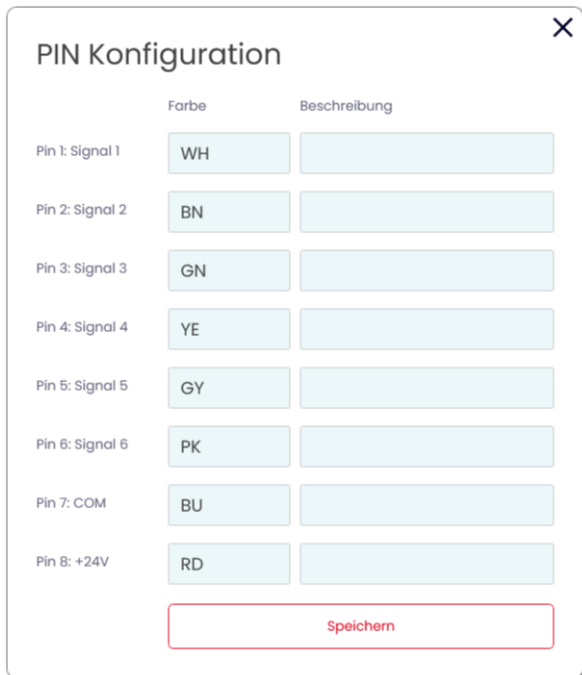

	Farbe	Beschreibung
Pin 1: Signal 1	WH	
Pin 2: Signal 2	BN	
Pin 3: Signal 3	GN	
Pin 4: Signal 4	YE	
Pin 5: Signal 5	GY	
Pin 6: Signal 6	PK	
Pin 7: COM	BU	
Pin 8: +24V	RD	

Speichern

2. In der Spalte **Farbe** die gewünschte Litzenfarbe eingeben.
3. In der Spalte **Beschreibung** die Beschreibung des Signals eingeben.
4. Auf **Speichern** klicken.

4.3.5 Ansteuerung simulieren

Nachdem alle Einstellungen vorgenommen wurden, kann die Ansteuerung simuliert werden.

1. In der Pin-Übersicht auf den Pin klicken, der die gewünschte Stufe aktivieren soll.

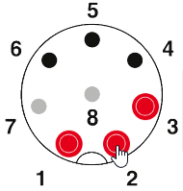

4.3.6 Konfiguration abschließen

1. Bei Bedarf weitere Änderungen an der Konfiguration vornehmen.
2. Sobald alle Stufen wie gewünscht konfiguriert sind, auf **Abschließen** klicken.
→ Das Fenster **Abschließen** erscheint.

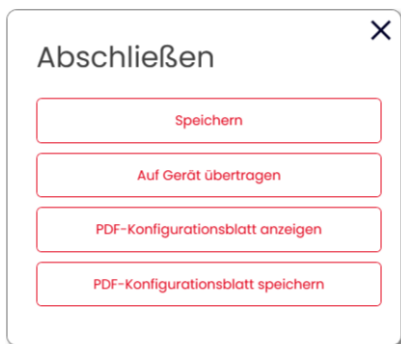

3. Auf **Speichern** klicken, um die Konfiguration in einer Konfigurationsdatei zu speichern.
4. Auf **Auf Gerät übertragen** klicken, um die Konfiguration auf die angeschlossene eSIGN zu übertragen.
5. Auf **PDF-Konfigurationsblatt anzeigen** klicken, um eine Übersicht der aktuellen Konfiguration anzuzeigen.
6. Auf **PDF-Konfigurationsblatt speichern** klicken, um die Übersicht der aktuellen Konfiguration als PDF-Datei zu speichern.

4.4 Modus Individual



In dieser Betriebsart wird eine beliebige Kombination aus individuellen Segmenteinstellungen als eigenes Schaltsignal abgebildet. Jedes eSIGN-Segment kann individuell eingestellt und die Gesamteinstellung für die komplette Säule als ein Signalbild angesteuert werden. Der Modus **Individual** ermöglicht auf diese Art und Weise ein Maximum an individuellen Signalisierungsmöglichkeiten.

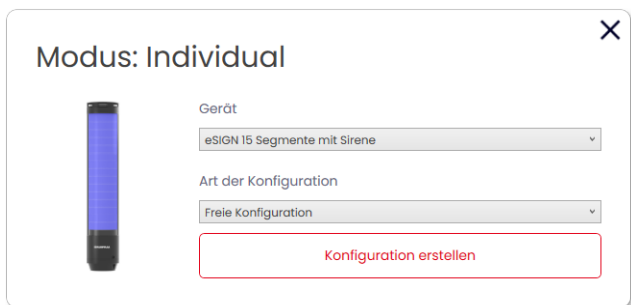

4.4.1 eSIGN-Variante wählen

Falls eine eSIGN angeschlossen wurde, ist die Variante entsprechend vorausgewählt. Falls keine eSIGN angeschlossen wurde, kann die Variante der zu konfigurierenden eSIGN gewählt werden.

1. Bei Bedarf im Feld **Gerät** die Variante der eSIGN wählen.

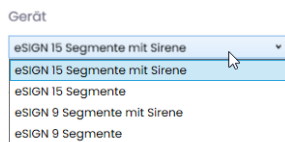

2. Auf **Konfiguration erstellen** klicken.
→ Der Bildschirm **Konfiguration** erscheint.

4.4.2 Signalbilder konfigurieren

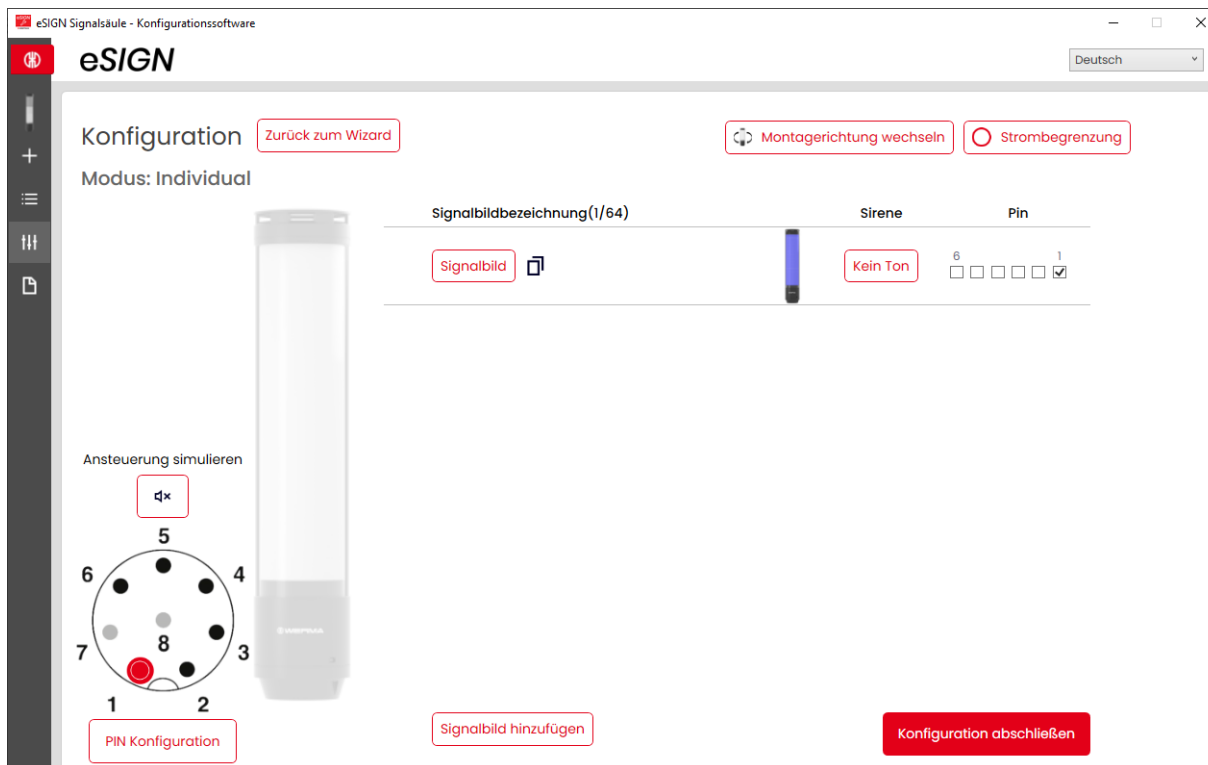

- i** Bei Bedarf kann die Ausrichtung der dargestellten Signalsäule über die Schaltfläche **Montagerichtung wechseln** um 180° gedreht werden.
- i** Bei Bedarf (z. B. um die Strombegrenzungen von Steuerungsausgängen berücksichtigen zu können) kann über die Schaltfläche **Strombegrenzung** die Leistungsaufnahme der eSIGN verringert werden. In diesem Fall wird der Strombedarf der Säule auf unter 500 mA reduziert. Als Folge wird die Helligkeit der optischen Signale bzw. die Lautstärke der akustischen Signale verringert.
- i** Bei Bedarf kann über den Link **Zurück zum Wizard** die Konfiguration der eSIGN-Variante erneut aufgerufen und angepasst werden.

Signalbild anpassen



Es können bis zu 64 Signalbilder konfiguriert und auf eine eSIGN übertragen werden.

Ein Signalbild besteht aus den einzelnen optischen Einstellungen jedes Segments und ggf. einem Signalton.

1. Auf **Signalbild** klicken.

Signalbildbezeichnung(1/64)



→ Das Fenster **Signalbild** erscheint.

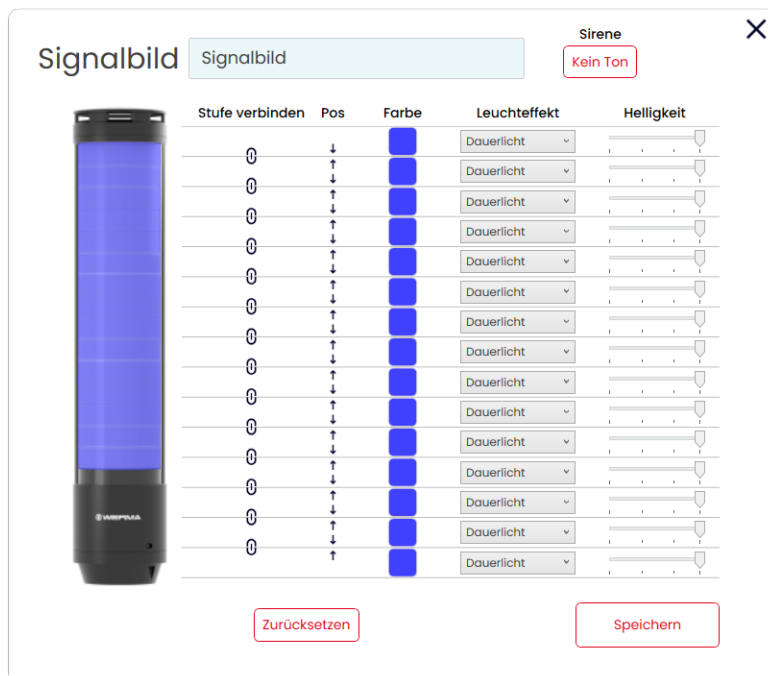

Bei Bedarf kann das aktuelle Signalbild über die Schaltfläche **Zurücksetzen** auf die Standardeinstellungen zurückgesetzt werden.

Signalbild benennen

1. Im Feld **Signalbild** eine Bezeichnung für das aktuelle Signalbild eingeben.

Sirene wählen

Falls die angeschlossene oder gewählte eSIGN eine Sirene hat, kann ein Signalton gewählt werden, der bei Aktivierung des Signalbilds ertönt.

1. Im Feld **Sirene** auf **Kein Ton** klicken.

Sirene



→ Das Fenster **Ton auswählen** erscheint.

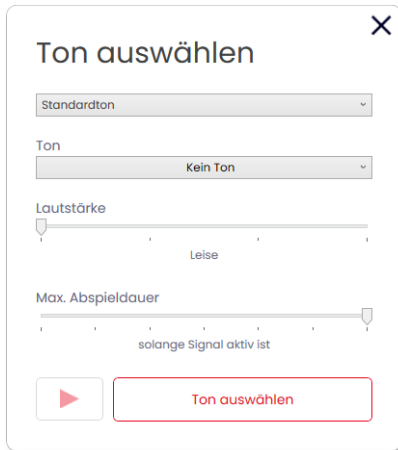



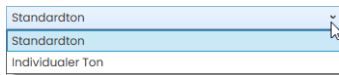



2. Wählen, ob ein Standardton oder eine individueller Ton verwendet werden soll.

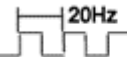
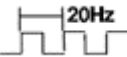
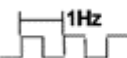

Standardton

3. Den gewünschten **Ton**, die gewünschte **Lautstärke** und **Max. Abspieldauer** wählen.

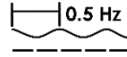
Folgenden 10 Tonarten stehen zur Auswahl zur Verfügung:

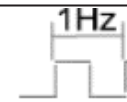
Ton	Frequenz	Beschreibung	Max. dB (A)
1	 2.7 kHz	Dauerton	104
2	 0.9 kHz	Dauerton	96
3	 2.8 kHz	Pulston	97
4	 0.9 kHz	Pulston	93
5	 2.8 kHz	Pulston	103
6	 0.9 kHz	Pulston	96
7	 2.8 kHz	Pulston	104
8	 2.3 kHz- 3.6 kHz	Wobbelton	104
9	 2.6 kHz	Dauerton	105
10	 1200 Hz 800 Hz	Wechselton	92



Die gewählten Einstellungen können über die Schaltfläche **Abspielen** (▶) getestet werden. Der wird dabei über den Computer abgespielt.

4. Auf **Ton auswählen** klicken.

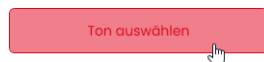

Individualer Ton

Ton auswählen
✕

Individualer Ton

Grafische Parameterbeschreibung

Lautstärke

Leise

Tonart

Dauerton

Haltedauer Frequenz 2(ms) ?

0

Frequenz 1 (Hz) ?

1000

Folge/Anzahl ?

0

Pause bis Wiederholung (ms) ?

0

Pause zwischen Zyklen (ms) ?

0

Ton auswählen

1. Einstellungen wie gewünscht vornehmen.



Die Option **Individualer Ton** bietet die Möglichkeit, aus verschiedenen Parametern, einen kundenindividuellen Ton zu generieren.

Weiterführende Informationen zu den einzelnen Einstellungen können über die Schaltfläche **Grafische Parameterbeschreibung** und durch Klick auf **?** aufgerufen werden.

Über die Schaltfläche **Grafische Parameterbeschreibung** kann folgendes Bild abgerufen werden, um die Auswirkung der einzelnen Einstellungen zu verdeutlichen:

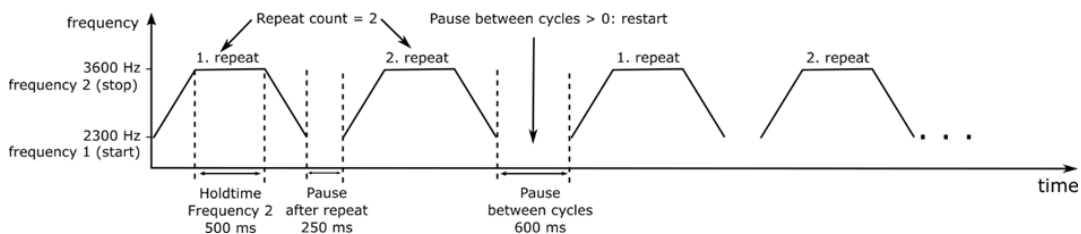

2. Auf **Ton auswählen** klicken.



Segmente verbinden oder trennen

Bei Bedarf können mehrere Segmente zu einer Stufe verbunden und wieder getrennt werden.

Segmente verbinden

1. In der Spalte **Stufen verbinden** auf das Symbol **Stufen verbinden** klicken.



Segmente trennen

1. In der Spalte **Stufen verbinden** auf das Symbol **Stufen trennen** klicken.



Stufen verschieben

Bei Bedarf können die einzelnen Stufen nach oben oder unten verschoben werden.

1. In der Spalte **Pos.** auf den Pfeil nach oben oder auf den Pfeil nach unten klicken, um die Stufe nach oben bzw. nach unten zu verschieben.

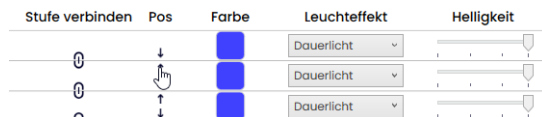

Farbe wählen

Für jedes einzelne Segment kann bei Bedarf eine vorgegebene Standardfarbe gewählt oder eine individuelle Farbe zugewiesen werden.

1. In der Spalte **Farbe** auf das Farbfeld klicken.



→ Das Fenster **Farbe auswählen** erscheint.



DE

2. Wählen, ob eine Standardfarbe oder eine individuelle Farbe verwendet werden soll.

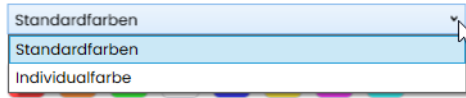

Standardfarbe

3. Auf das gewünschte Farbfeld klicken.



Folgende 8 Standardfarben stehen zur Auswahl zur Verfügung:

- rot
- gelb
- grün
- weiß
- blau
- hellgelb
- violett
- türkis

Individualfarbe

4. Gewünschte Farbe im Farbfeld auswählen oder den entsprechenden RGB-Wert in den Feldern **Rot**, **Grün** und **Blau** eingeben.

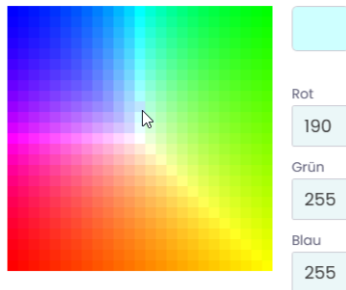

5. Auf **Farbe auswählen** klicken.



Leuchteffekt wählen

1. In der Spalte **Leuchteffekt** den gewünschten Leuchteffekt wählen.

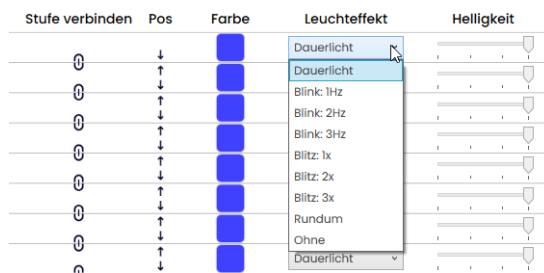

Folgenden 8 Leuchteffekte stehen zur Auswahl zur Verfügung:

- Dauerlicht
- Blink 1Hz
- Blink 2Hz
- Blink 3Hz
- Blitz 1x
- Blitz 2x
- Blitz 3x
- Rundum
- Ohne

Helligkeit einstellen

1. In der Spalte **Helligkeit** aus den 4 Optionen die gewünschte Helligkeit der Stufe einstellen.

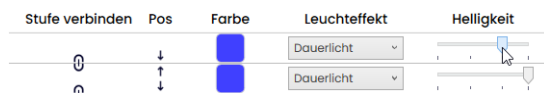

Sobald alle Einstellungen vorgenommen wurden:

2. Auf **Speichern** klicken.

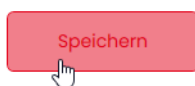

4.4.3 Pin wählen

- i** Die Felder sind mit einer Standardbelegung vorkonfiguriert.
Die Belegung kann bei Bedarf beliebig verändert werden.

Die Ansteuerung der einzelnen Signaltbilder erfolgt über eine Bit-Codierung. Die Kontrollkästchen in der Spalte **Pin** entsprechen den 6 Pins bzw. Signalleitungen. Das Setzen eines Hakens in einem oder mehreren Kontrollkästchen zeigt an, dass diese Pins bzw. Signalleitungen angesteuert werden müssen, um das entsprechende Signaltbild zu aktivieren.

Beispiel:

Für die Aktivierung des Signaltbilds **Signalbild_01** müssen die Pins 1-4 angesteuert werden.

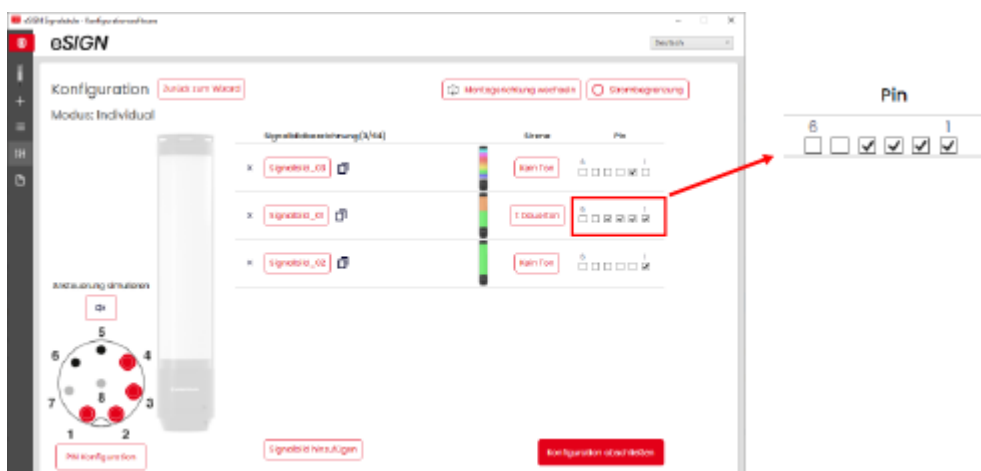

1. In der Spalte **Pin** die Pins des 8-poligen Steckers wählen, auf dem das Signal zum Auslösen des Signaltbilds gesendet wird.

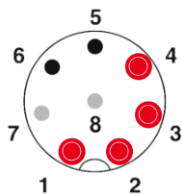
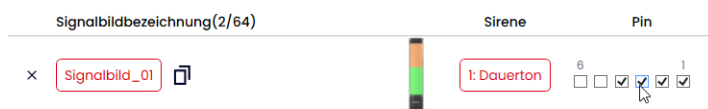

Pin-Konfiguration anpassen

Bei Bedarf kann die Zuordnung der Litzenfarbe zum Pin geändert und eine Beschreibung des Signals hinterlegt werden.

1. Unter der Pin-Übersicht auf **PIN Konfiguration** klicken.

PIN Konfiguration

→ Das Fenster **PIN Konfiguration** erscheint.

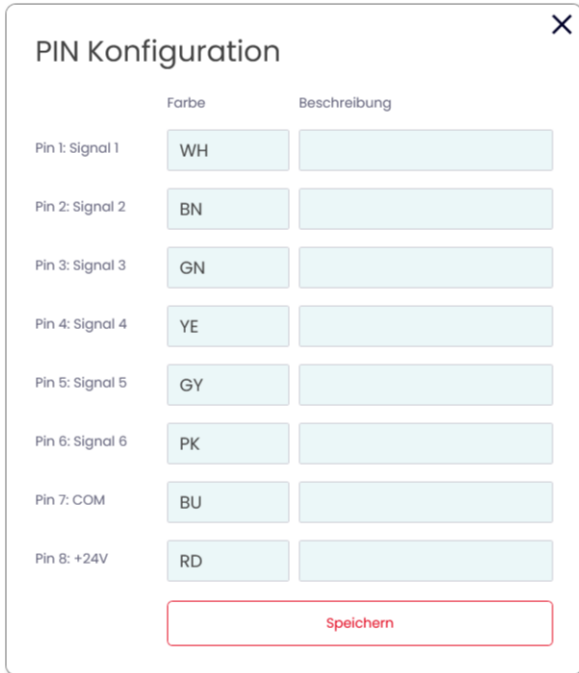

	Farbe	Beschreibung
Pin 1: Signal 1	WH	
Pin 2: Signal 2	BN	
Pin 3: Signal 3	GN	
Pin 4: Signal 4	YE	
Pin 5: Signal 5	GY	
Pin 6: Signal 6	PK	
Pin 7: COM	BU	
Pin 8: +24V	RD	

Speichern

2. In der Spalte **Farbe** die gewünschte Litzenfarbe eingeben.
3. In der Spalte **Beschreibung** die Beschreibung des Signals eingeben.
4. Auf **Speichern** klicken.

4.4.4 Signalbild duplizieren



Es können bis zu 64 Signalbilder konfiguriert und auf eine eSIGN übertragen werden.

Ein Signalbild besteht aus den einzelnen optischen Einstellungen jedes Segments und ggf. einem Signalton.

1. In der Zeile des gewünschten Signalbilds auf **Duplizieren** klicken.



2. Das Signalbild wie beschrieben konfigurieren.

4.4.5 Signalbild hinzufügen



Es können bis zu 64 Signalbilder konfiguriert und auf eine eSIGN übertragen werden.

Ein Signalbild besteht aus den einzelnen optischen Einstellungen jedes Segments und ggf. einem Signalton.

1. Auf **Signalbild hinzufügen** klicken.

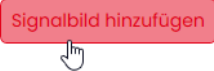

2. Das Signalbild wie beschrieben konfigurieren.

4.4.6 Signalbild löschen

1. In der Zeile des gewünschten Signalbilds auf **Entfernen** klicken.



4.4.7 Ansteuerung simulieren

Nachdem alle Einstellungen vorgenommen wurden, kann die Ansteuerung simuliert werden.

1. In der Pin-Übersicht auf den Pin klicken, der das gewünschte Signalbild aktivieren soll.

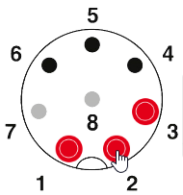

4.4.8 Konfiguration abschließen

1. Bei Bedarf weitere Änderungen an der Konfiguration vornehmen.
2. Sobald alle Signalbilder wie gewünscht konfiguriert sind, auf **Abschließen** klicken.
→ Das Fenster **Abschließen** erscheint.



3. Auf **Speichern** klicken, um die Konfiguration in einer Konfigurationsdatei zu speichern.
4. Auf **Auf Gerät übertragen** klicken, um die Konfiguration auf die angeschlossene eSIGN zu übertragen.
5. Auf **PDF-Konfigurationsblatt anzeigen** klicken, um eine Übersicht der aktuellen Konfiguration anzuzeigen.
6. Auf **PDF-Konfigurationsblatt speichern** klicken, um die Übersicht der aktuellen Konfiguration als PDF-Datei zu speichern.

5 Konfiguration aus Beispielvorlagen übernehmen

Die eSIGN-Konfigurationssoftware stellt verschiedene vordefinierte Konfigurationen bereit, die direkt auf eine angeschlossene eSIGN übertragen oder als Grundlage für eigene Konfigurationen verwendet werden können.

1. Im Bereich **Konfiguration** auf **Aus Beispielvorlagen übernehmen** klicken.

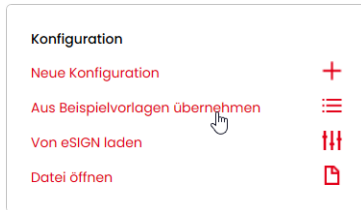

→ Das Fenster **Konfiguration aus Beispielvorlagen übernehmen** erscheint.

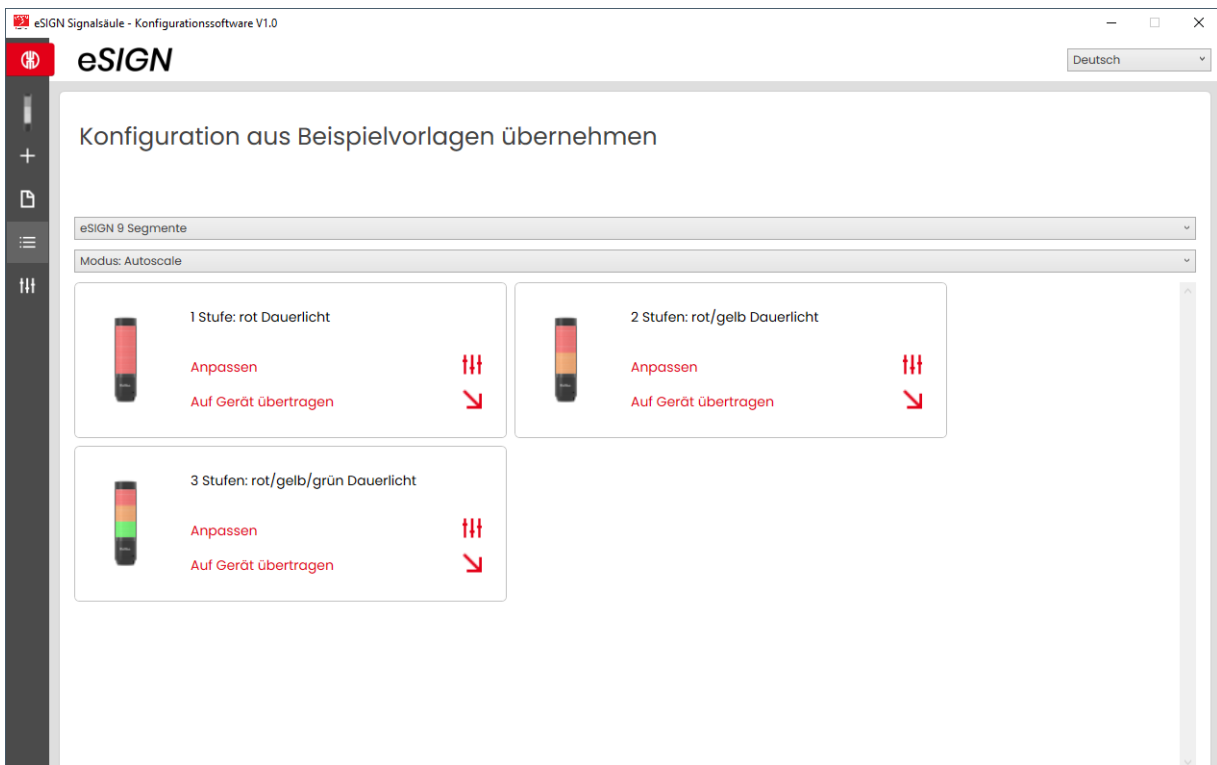

2. Variante der eSIGN wählen.
3. Modus wählen.
→ Die verfügbaren Vorlagen werden angezeigt.
4. In der gewünschten Vorlage auf **Anpassen** klicken, um die Vorlage zu laden und weiter zu bearbeiten.

5. Auf **Auf Gerät übertragen** klicken, um die Vorlage zu laden und direkt auf die angeschlossene eSIGN zu übertragen.

 Für weitere Informationen zur Konfiguration, siehe "*Neue Konfiguration erstellen*", S. 15.

6 Konfiguration von der angeschlossener eSIGN laden

Falls eine eSIGN am Computer angeschlossen ist, bietet die eSIGN-Konfigurationssoftware die Möglichkeit, die aktuelle Konfiguration (ggf. Auslieferungszustand) zur Bearbeitung zu öffnen. Falls keine eSIGN angeschlossen ist, ist dieser Menüpunkt verblasst.

1. Im Bereich **Konfiguration** auf **Von eSIGN laden** klicken.

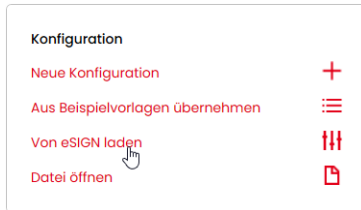

→ Das Fenster **Konfiguration** erscheint im eingestellten Modus und ist bereits mit der aktuellen Konfiguration befüllt.



Für weitere Informationen zur Konfiguration, siehe "Neue Konfiguration erstellen", S. 15.

7 Bestehende Konfiguration öffnen

1. Im Bereich **Konfiguration** auf **Datei öffnen** klicken.

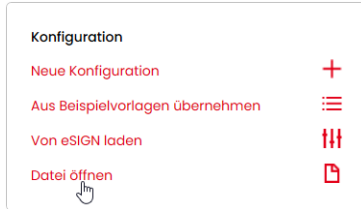

2. Gewünschte Konfigurationsdatei wählen und auf **Öffnen** klicken.



Alternativ kann über das Seitenmenü die zuletzt verwendete Konfigurationen angezeigt werden (siehe "Überblick", S. 13).

8 eSIGN-Konfigurationssoftware aktualisieren



Um eine Software-Aktualisierung durchführen zu können, muss der Computer mit dem Internet verbunden sein.

1. Im Bereich Diese Software auf **Auf neue Version prüfen** klicken.

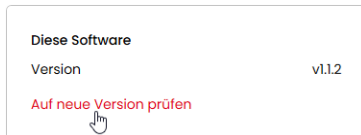

- Die eSIGN-Konfigurationssoftware sucht nach Software-Aktualisierungen.
- Falls eine Aktualisierung gefunden wurde, erscheint eine entsprechende Meldung.

9 Firmware aktualisieren

-  Um eine Firmware-Aktualisierung durchführen zu können, muss der Computer mit dem Internet verbunden sein und eine eSIGN angeschlossen sein.

1. Im Bereich Firmware auf **Auf neue Firmware prüfen** klicken.



- Die eSIGN-Konfigurationssoftware sucht nach Firmware-Aktualisierungen für die angeschlossene eSIGN.
- Falls eine Aktualisierung gefunden wurde, erscheint eine entsprechende Meldung.

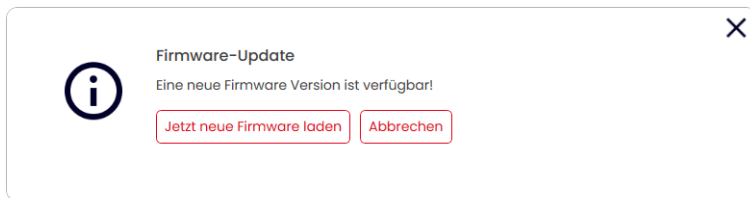

2. Auf **Jetzt neue Firmware laden** klicken.
- Die neue Firmware wird auf die angeschlossene eSIGN übertragen.

10 Support



WERMA Signaltechnik GmbH + Co.KG

D-78604 Rietheim-Weilheim

Support : +49 (0)7424 / 9557-222

Fax: +49 (0)7424 / 9557-44

support@werma.com

www.werma.com

Werma eSIGN - OSS-Lizenzvereinbarungen

INFORMATIONEN UND VERMERKE IN BEZUG AUF DIE IM GERÄT ENTHALTENEN OPEN SOURCE SOFTWAREKOMPONENTEN

Die folgende Auflistung enthält alle im Steuerungssystem der Werma eSIGN Signalsäule verwendeten Open Source Softwarekomponenten, inklusive der verwendeten Lizenzbedingung(en) unter welchen die Software genutzt werden darf sowie eventuell vorhandene Urhebervermerke.

Das Steuerungssystem der Werma eSIGN Signalsäule enthält folgende Open Source Softwarekomponenten:

INFORMATIONEN UND VERMERKE IN BEZUG AUF DIE IM GERÄT

ENTHALTENEN OPEN SOURCE SOFTWAREKOMPONENTEN	1
I. Newlib	1
II. Xtensa header files	26
III. Original parts of FreeRTOS.....	26
IV. FatFS library.....	27
V. SPIFFS library.....	27
VI. TLSF allocator Two Level Segregated Fit memory allocator.....	28
VII. HTTP Parser Based on src/http/nginx_http_parse.c	29
VIII. miniz.....	29
IX. tinyuf2.....	30
X. cJSON	31
XI. Xtensa libhal	31
XII. TinyBasic Plus	32
XIII. wpa_supplicant	32
XIV. TJpgDec.....	33
XV. tinyusb.....	34

Nachfolgend wird jeder Open Source Softwarekomponente der jeweils zutreffende Lizenztext zugeordnet.

I. **Newlib**

The newlib subdirectory is a collection of software from several sources.

Each file may have its own copyright/license that is embedded in the source file. Unless otherwise noted in the body of the source file(s), the

following copyright notices will apply to the contents of the newlib subdirectory:

1. Red Hat Incorporated

Copyright © 1994-2009 Red Hat, Inc. All rights reserved.

This copyrighted material is made available to anyone wishing to use, modify, copy, or redistribute it subject to the terms and conditions of the BSD License. This program is distributed in the hope that it will be useful, but WITHOUT ANY WARRANTY expressed or implied, including the implied warranties of MERCHANTABILITY or FITNESS FOR A PARTICULAR PURPOSE. A copy of this license is available at <http://www.opensource.org/licenses>. Any Red Hat trademarks that are incorporated in the source code or documentation are not subject to the BSD License and may only be used or replicated with the express permission of Red Hat, Inc.

2. University of California, Berkeley

Copyright © 1981-2000 The Regents of the University of California. All rights reserved.

Redistribution and use in source and binary forms, with or without modification, are permitted provided that the following conditions are met:

- Redistributions of source code must retain the above copyright notice, this list of conditions and the following disclaimer.
- Redistributions in binary form must reproduce the above copyright notice, this list of conditions and the following disclaimer in the documentation and/or other materials provided with the distribution.
- Neither the name of the University nor the names of its contributors may be used to endorse or promote products derived from this software without specific prior written permission.

THIS SOFTWARE IS PROVIDED BY THE COPYRIGHT HOLDERS AND CONTRIBUTORS "AS IS" AND ANY EXPRESS OR IMPLIED WARRANTIES, INCLUDING, BUT NOT LIMITED TO, THE IMPLIED WARRANTIES OF MERCHANTABILITY AND FITNESS FOR A PARTICULAR PURPOSE ARE DISCLAIMED. IN NO EVENT SHALL THE COPYRIGHT OWNER OR CONTRIBUTORS BE LIABLE FOR ANY

DIRECT, INDIRECT, INCIDENTAL, SPECIAL, EXEMPLARY, OR CONSEQUENTIAL DAMAGES (INCLUDING, BUT NOT LIMITED TO, PROCUREMENT OF SUBSTITUTE GOODS OR SERVICES; LOSS OF USE, DATA, OR PROFITS; OR BUSINESS INTERRUPTION) HOWEVER CAUSED AND ON ANY THEORY OF LIABILITY, WHETHER IN CONTRACT, STRICT LIABILITY, OR TORT (INCLUDING NEGLIGENCE OR OTHERWISE) ARISING IN ANY WAY OUT OF THE USE OF THIS SOFTWARE, EVEN IF ADVISED OF THE POSSIBILITY OF SUCH DAMAGE.

3. David M. Gay (AT&T 1991, Lucent 1998)

The author of this software is David M. Gay.

Copyright © 1991 by AT&T.

Permission to use, copy, modify, and distribute this software for any purpose without fee is hereby granted, provided that this entire notice is included in all copies of any software which is or includes a copy or modification of this software and in all copies of the supporting documentation for such software.

THIS SOFTWARE IS BEING PROVIDED "AS IS", WITHOUT ANY EXPRESS OR IMPLIED WARRANTY. IN PARTICULAR, NEITHER THE AUTHOR NOR AT&T MAKES ANY REPRESENTATION OR WARRANTY OF ANY KIND CONCERNING THE MERCHANTABILITY OF THIS SOFTWARE OR ITS FITNESS FOR ANY PARTICULAR PURPOSE.

The author of this software is David M. Gay.

Copyright © 1998-2001 by Lucent Technologies All Rights Reserved

Permission to use, copy, modify, and distribute this software and its documentation for any purpose and without fee is hereby granted, provided that the above copyright notice appear in all copies and that both that the copyright notice and this permission notice and warranty disclaimer appear in supporting documentation, and that the name of Lucent or any of its entities not be used in advertising or publicity pertaining to distribution of the software without specific, written prior permission.

LUCENT DISCLAIMS ALL WARRANTIES WITH REGARD TO THIS SOFTWARE, INCLUDING ALL IMPLIED WARRANTIES OF MERCHANTABILITY AND FITNESS. IN NO EVENT SHALL LUCENT OR ANY OF ITS ENTITIES BE LIABLE FOR ANY SPECIAL, INDIRECT OR CONSEQUENTIAL DAMAGES OR ANY DAMAGES WHATSOEVER RESULTING FROM LOSS OF USE, DATA OR PROFITS, WHETHER IN AN ACTION OF CONTRACT, NEGLIGENCE OR OTHER TORTIOUS ACTION, ARISING OUT OF OR IN CONNECTION WITH THE USE OR PERFORMANCE OF THIS SOFTWARE.

4. Advanced Micro Devices

Copyright 1989, 1990 Advanced Micro Devices, Inc.

This software is the property of Advanced Micro Devices, Inc (AMD) which specifically grants the user the right to modify, use and distribute this software provided this notice is not removed or altered. All other rights are reserved by AMD.

AMD MAKES NO WARRANTY OF ANY KIND, EXPRESS OR IMPLIED, WITH REGARD TO THIS SOFTWARE. IN NO EVENT SHALL AMD BE LIABLE FOR INCIDENTAL OR CONSEQUENTIAL DAMAGES IN CONNECTION WITH OR ARISING FROM THE FURNISHING, PERFORMANCE, OR USE OF THIS SOFTWARE.

So that all may benefit from your experience, please report any problems or suggestions about this software to the 29K Technical Support Center at 800-29-29-AMD (800-292-9263) in the USA, or 0800-89-1131 in the UK, or 0031-11-1129 in Japan, toll free. The direct dial number is 512-462-4118.

Advanced Micro Devices, Inc.
29K Support Products
Mail Stop 573
5900 E. Ben White Blvd.
Austin, TX 78741
800-292-9263

5. [blank]

6. [blank]

7. Sun Microsystems

Copyright © 1993 by Sun Microsystems, Inc. All rights reserved.

Developed at SunPro, a Sun Microsystems, Inc. business. Permission to use, copy, modify, and distribute this software is freely granted, provided that this notice is preserved.

8. Hewlett Packard

© Copyright 1986 HEWLETT-PACKARD COMPANY

To anyone who acknowledges that this file is provided "AS IS" without any express or implied warranty: permission to use, copy, modify, and distribute this file for any purpose is hereby granted without fee, provided that the above copyright notice and this notice appears in all copies, and that the name of Hewlett-Packard Company not be used in advertising or publicity pertaining to distribution of the software without specific, written prior permission. Hewlett-Packard Company makes no representations about the suitability of this software for any purpose.

9. Hans-Peter Nilsson

Copyright © 2001 Hans-Peter Nilsson

Permission to use, copy, modify, and distribute this software is freely granted, provided that the above copyright notice, this notice and the following disclaimer are preserved with no changes.

THIS SOFTWARE IS PROVIDED ``AS IS" AND WITHOUT ANY EXPRESS OR IMPLIED WARRANTIES, INCLUDING, WITHOUT LIMITATION, THE IMPLIED WARRANTIES OF MERCHANTABILITY AND FITNESS FOR A PARTICULAR PURPOSE.

10. Stephane Carrez (m68hc11-elf/m68hc12-elf targets only)

Copyright © 1999, 2000, 2001, 2002 Stephane Carrez (stcarrez@nerim.fr)

The authors hereby grant permission to use, copy, modify, distribute, and license this software and its documentation for any purpose, provided that existing copyright notices are retained in all copies and that this notice is included verbatim in any distributions. No written agreement, license, or royalty fee is required for any of the authorized uses. Modifications to this software may be copyrighted by their authors and need not follow the licensing terms described here, provided that the new terms are clearly indicated on the first page of each file where they apply.

11. Christopher G. Demetriou

Copyright © 2001 Christopher G. Demetriou All rights reserved.

Redistribution and use in source and binary forms, with or without modification, are permitted provided that the following conditions are met:

1. Redistributions of source code must retain the above copyright notice, this list of conditions and the following disclaimer.
2. Redistributions in binary form must reproduce the above copyright notice, this list of conditions and the following disclaimer in the documentation and/or other materials provided with the distribution.
3. The name of the author may not be used to endorse or promote products derived from this software without specific prior written permission.

THIS SOFTWARE IS PROVIDED BY THE AUTHOR ``AS IS" AND ANY EXPRESS OR IMPLIED WARRANTIES, INCLUDING, BUT NOT LIMITED TO, THE IMPLIED WARRANTIES OF MERCHANTABILITY AND FITNESS FOR A PARTICULAR PURPOSE ARE DISCLAIMED. IN NO EVENT SHALL THE AUTHOR BE LIABLE FOR ANY DIRECT, INDIRECT, INCIDENTAL, SPECIAL, EXEMPLARY, OR CONSEQUENTIAL DAMAGES (INCLUDING, BUT NOT LIMITED TO, PROCUREMENT OF SUBSTITUTE GOODS OR SERVICES; LOSS OF USE, DATA, OR PROFITS; OR BUSINESS INTERRUPTION) HOWEVER CAUSED AND ON ANY THEORY OF LIABILITY, WHETHER IN CONTRACT, STRICT LIABILITY, OR TORT (INCLUDING NEGLIGENCE OR OTHERWISE) ARISING IN ANY WAY OUT OF THE USE OF THIS SOFTWARE, EVEN IF ADVISED OF THE POSSIBILITY OF SUCH DAMAGE.

12. SuperH, Inc.

Copyright 2002 SuperH, Inc. All rights reserved

This software is the property of SuperH, Inc (SuperH) which specifically grants the user the right to modify, use and distribute this software provided this notice is not removed or altered. All other rights are reserved by SuperH.

SUPERH MAKES NO WARRANTY OF ANY KIND, EXPRESS OR IMPLIED, WITH REGARD TO THIS SOFTWARE. IN NO EVENT SHALL SUPERH BE LIABLE FOR INDIRECT, SPECIAL, INCIDENTAL OR CONSEQUENTIAL DAMAGES IN CONNECTION WITH OR ARISING FROM THE FURNISHING, PERFORMANCE, OR USE OF THIS SOFTWARE.

So that all may benefit from your experience, please report any problems or suggestions about this software to the SuperH Support Center via e-mail at softwaresupport@superh.com.

SuperH, Inc.
405 River Oaks Parkway
San Jose
CA 95134
USA

13. Royal Institute of Technology

Copyright © 1999 Kungliga Tekniska Högskolan
(Royal Institute of Technology, Stockholm, Sweden).

All rights reserved.

Redistribution and use in source and binary forms, with or without modification, are permitted provided that the following conditions are met:

1. Redistributions of source code must retain the above copyright notice, this list of conditions and the following disclaimer.
2. Redistributions in binary form must reproduce the above copyright notice, this list of conditions and the following disclaimer in the documentation and/or other materials provided with the distribution.

3. Neither the name of KTH nor the names of its contributors may be used to endorse or promote products derived from this software without specific prior written permission.

THIS SOFTWARE IS PROVIDED BY KTH AND ITS CONTRIBUTORS ``AS IS" AND ANY EXPRESS OR IMPLIED WARRANTIES, INCLUDING, BUT NOT LIMITED TO, THE IMPLIED WARRANTIES OF MERCHANTABILITY AND FITNESS FOR A PARTICULAR PURPOSE ARE DISCLAIMED. IN NO EVENT SHALL KTH OR ITS CONTRIBUTORS BE LIABLE FOR ANY DIRECT, INDIRECT, INCIDENTAL, SPECIAL, EXEMPLARY, OR CONSEQUENTIAL DAMAGES (INCLUDING, BUT NOT LIMITED TO, PROCUREMENT OF SUBSTITUTE GOODS OR SERVICES; LOSS OF USE, DATA, OR PROFITS; OR BUSINESS INTERRUPTION) HOWEVER CAUSED AND ON ANY THEORY OF LIABILITY, WHETHER IN CONTRACT, STRICT LIABILITY, OR TORT (INCLUDING NEGLIGENCE OR OTHERWISE) ARISING IN ANY WAY OUT OF THE USE OF THIS SOFTWARE, EVEN IF ADVISED OF THE POSSIBILITY OF SUCH DAMAGE.

14. Alexey Zelkin

Copyright © 2000, 2001 Alexey Zelkin <phantom@FreeBSD.org> All rights reserved.

Redistribution and use in source and binary forms, with or without modification, are permitted provided that the following conditions are met:

1. Redistributions of source code must retain the above copyright notice, this list of conditions and the following disclaimer.
2. Redistributions in binary form must reproduce the above copyright notice, this list of conditions and the following disclaimer in the documentation and/or other materials provided with the distribution.

THIS SOFTWARE IS PROVIDED BY THE AUTHOR AND CONTRIBUTORS ``AS IS" AND ANY EXPRESS OR IMPLIED WARRANTIES, INCLUDING, BUT NOT LIMITED TO, THE IMPLIED WARRANTIES OF MERCHANTABILITY AND FITNESS FOR A PARTICULAR PURPOSE ARE DISCLAIMED. IN NO EVENT SHALL THE AUTHOR OR CONTRIBUTORS BE LIABLE FOR ANY DIRECT, INDIRECT, INCIDENTAL, SPECIAL, EXEMPLARY, OR CONSEQUENTIAL DAMAGES (INCLUDING, BUT NOT LIMITED TO, PROCUREMENT OF SUBSTITUTE GOODS OR SERVICES; LOSS OF USE, DATA, OR PROFITS; OR BUSINESS INTERRUPTION) HOWEVER

CAUSED AND ON ANY THEORY OF LIABILITY, WHETHER IN CONTRACT, STRICT LIABILITY, OR TORT (INCLUDING NEGLIGENCE OR OTHERWISE) ARISING IN ANY WAY OUT OF THE USE OF THIS SOFTWARE, EVEN IF ADVISED OF THE POSSIBILITY OF SUCH DAMAGE.

15. Andrey A. Chernov

Copyright © 1997 by Andrey A. Chernov, Moscow, Russia. All rights reserved.

Redistribution and use in source and binary forms, with or without modification, are permitted provided that the following conditions are met:

1. Redistributions of source code must retain the above copyright notice, this list of conditions and the following disclaimer.
2. Redistributions in binary form must reproduce the above copyright notice, this list of conditions and the following disclaimer in the documentation and/or other materials provided with the distribution.

THIS SOFTWARE IS PROVIDED BY THE AUTHOR ``AS IS" AND ANY EXPRESS OR IMPLIED WARRANTIES, INCLUDING, BUT NOT LIMITED TO, THE IMPLIED WARRANTIES OF MERCHANTABILITY AND FITNESS FOR A PARTICULAR PURPOSE ARE DISCLAIMED. IN NO EVENT SHALL THE REGENTS OR CONTRIBUTORS BE LIABLE FOR ANY DIRECT, INDIRECT, INCIDENTAL, SPECIAL, EXEMPLARY, OR CONSEQUENTIAL DAMAGES (INCLUDING, BUT NOT LIMITED TO, PROCUREMENT OF SUBSTITUTE GOODS OR SERVICES; LOSS OF USE, DATA, OR PROFITS; OR BUSINESS INTERRUPTION) HOWEVER CAUSED AND ON ANY THEORY OF LIABILITY, WHETHER IN CONTRACT, STRICT LIABILITY, OR TORT (INCLUDING NEGLIGENCE OR OTHERWISE) ARISING IN ANY WAY OUT OF THE USE OF THIS SOFTWARE, EVEN IF ADVISED OF THE POSSIBILITY OF SUCH DAMAGE.

16. FreeBSD

Copyright © 1997-2002 FreeBSD Project. All rights reserved.

Redistribution and use in source and binary forms, with or without modification, are permitted provided that the following conditions are met:

1. Redistributions of source code must retain the above copyright notice, this list of conditions and the following disclaimer.
2. Redistributions in binary form must reproduce the above copyright notice, this list of conditions and the following disclaimer in the documentation and/or other materials provided with the distribution.

THIS SOFTWARE IS PROVIDED BY THE AUTHOR AND CONTRIBUTORS ``AS IS'' AND ANY EXPRESS OR IMPLIED WARRANTIES, INCLUDING, BUT NOT LIMITED TO, THE IMPLIED WARRANTIES OF MERCHANTABILITY AND FITNESS FOR A PARTICULAR PURPOSE ARE DISCLAIMED. IN NO EVENT SHALL THE AUTHOR OR CONTRIBUTORS BE LIABLE FOR ANY DIRECT, INDIRECT, INCIDENTAL, SPECIAL, EXEMPLARY, OR CONSEQUENTIAL DAMAGES (INCLUDING, BUT NOT LIMITED TO, PROCUREMENT OF SUBSTITUTE GOODS OR SERVICES; LOSS OF USE, DATA, OR PROFITS; OR BUSINESS INTERRUPTION) HOWEVER CAUSED AND ON ANY THEORY OF LIABILITY, WHETHER IN CONTRACT, STRICT LIABILITY, OR TORT (INCLUDING NEGLIGENCE OR OTHERWISE) ARISING IN ANY WAY OUT OF THE USE OF THIS SOFTWARE, EVEN IF ADVISED OF THE POSSIBILITY OF SUCH DAMAGE.

17. S. L. Moshier

Author: S. L. Moshier.

Copyright © 1984,2000 S.L. Moshier

Permission to use, copy, modify, and distribute this software for any purpose without fee is hereby granted, provided that this entire notice is included in all copies of any software which is or includes a copy or modification of this software and in all copies of the supporting documentation for such software.

THIS SOFTWARE IS BEING PROVIDED "AS IS", WITHOUT ANY EXPRESS OR IMPLIED WARRANTY. IN PARTICULAR, THE AUTHOR MAKES NO REPRESENTATION OR WARRANTY OF ANY KIND CONCERNING THE MERCHANTABILITY OF THIS SOFTWARE OR ITS FITNESS FOR ANY PARTICULAR PURPOSE.

18. Citrus Project

Copyright © 1999 Citrus Project, All rights reserved.

Redistribution and use in source and binary forms, with or without modification, are permitted provided that the following conditions are met:

1. Redistributions of source code must retain the above copyright notice, this list of conditions and the following disclaimer.
2. Redistributions in binary form must reproduce the above copyright notice, this list of conditions and the following disclaimer in the documentation and/or other materials provided with the distribution.

THIS SOFTWARE IS PROVIDED BY THE AUTHOR AND CONTRIBUTORS ``AS IS'' AND ANY EXPRESS OR IMPLIED WARRANTIES, INCLUDING, BUT NOT LIMITED TO, THE IMPLIED WARRANTIES OF MERCHANTABILITY AND FITNESS FOR A PARTICULAR PURPOSE ARE DISCLAIMED. IN NO EVENT SHALL THE AUTHOR OR CONTRIBUTORS BE LIABLE FOR ANY DIRECT, INDIRECT, INCIDENTAL, SPECIAL, EXEMPLARY, OR CONSEQUENTIAL DAMAGES (INCLUDING, BUT NOT LIMITED TO, PROCUREMENT OF SUBSTITUTE GOODS OR SERVICES; LOSS OF USE, DATA, OR PROFITS; OR BUSINESS INTERRUPTION) HOWEVER CAUSED AND ON ANY THEORY OF LIABILITY, WHETHER IN CONTRACT, STRICT LIABILITY, OR TORT (INCLUDING NEGLIGENCE OR OTHERWISE) ARISING IN ANY WAY OUT OF THE USE OF THIS SOFTWARE, EVEN IF ADVISED OF THE POSSIBILITY OF SUCH DAMAGE.

19. Todd C. Miller

Copyright © 1998 Todd C. Miller <Todd.Miller@courtesan.com>

All rights reserved.

Redistribution and use in source and binary forms, with or without modification, are permitted provided that the following conditions are met:

1. Redistributions of source code must retain the above copyright notice, this list of conditions and the following disclaimer.
2. Redistributions in binary form must reproduce the above copyright notice, this list of conditions and the following disclaimer in the documentation and/or other materials provided with the distribution.

3. The name of the author may not be used to endorse or promote products derived from this software without specific prior written permission.

THIS SOFTWARE IS PROVIDED ``AS IS" AND ANY EXPRESS OR IMPLIED WARRANTIES, INCLUDING, BUT NOT LIMITED TO, THE IMPLIED WARRANTIES OF MERCHANTABILITY AND FITNESS FOR A PARTICULAR PURPOSE ARE DISCLAIMED. IN NO EVENT SHALL THE AUTHOR BE LIABLE FOR ANY DIRECT, INDIRECT, INCIDENTAL, SPECIAL, EXEMPLARY, OR CONSEQUENTIAL DAMAGES (INCLUDING, BUT NOT LIMITED TO, PROCUREMENT OF SUBSTITUTE GOODS OR SERVICES; LOSS OF USE, DATA, OR PROFITS; OR BUSINESS INTERRUPTION) HOWEVER CAUSED AND ON ANY THEORY OF LIABILITY, WHETHER IN CONTRACT, STRICT LIABILITY, OR TORT (INCLUDING NEGLIGENCE OR OTHERWISE) ARISING IN ANY WAY OUT OF THE USE OF THIS SOFTWARE, EVEN IF ADVISED OF THE POSSIBILITY OF SUCH DAMAGE.

20. DJ Delorie (i386)

Copyright © 1991 DJ Delorie All rights reserved.

Redistribution, modification, and use in source and binary forms is permitted provided that the above copyright notice and following paragraph are duplicated in all such forms.

This file is distributed WITHOUT ANY WARRANTY; without even the implied warranty of MERCHANTABILITY or FITNESS FOR A PARTICULAR PURPOSE.

21. Free Software Foundation LGPL License (*-linux* targets only)

Copyright © 1990-1999, 2000, 2001 Free Software Foundation, Inc.

This file is part of the GNU C Library.

Contributed by Mark Kettenis <kettenis@phys.uva.nl>, 1997.

The GNU C Library is free software; you can redistribute it and/or modify it under the terms of the GNU Lesser General Public License as published by the Free Software Foundation; either version 2.1 of the License, or (at your option) any later version.

The GNU C Library is distributed in the hope that it will be useful, but WITHOUT ANY WARRANTY; without even the implied warranty of MERCHANTABILITY or FITNESS FOR A PARTICULAR PURPOSE. See the GNU Lesser General Public License for more details.

You should have received a copy of the GNU Lesser General Public License along with the GNU C Library; if not, write to the Free Software Foundation, Inc., 51 Franklin Street, Fifth Floor, Boston, MA 02110-1301 USA.

22. Xavier Leroy LGPL License (i[3456]86-*-linux* targets only)

Copyright © 1996 Xavier Leroy (Xavier.Leroy@inria.fr)

This program is free software; you can redistribute it and/or modify it under the terms of the GNU Library General Public License as published by the Free Software Foundation; either version 2 of the License, or (at your option) any later version.

This program is distributed in the hope that it will be useful, but WITHOUT ANY WARRANTY; without even the implied warranty of MERCHANTABILITY or FITNESS FOR A PARTICULAR PURPOSE. See the GNU Library General Public License for more details.

23. Intel (i960)

Copyright © 1993 Intel Corporation

Intel hereby grants you permission to copy, modify, and distribute this software and its documentation. Intel grants this permission provided that the above copyright notice appears in all copies and that both the copyright notice and this permission notice appear in supporting documentation. In addition, Intel grants this permission provided that you prominently mark as "not part of the original" any modifications made to this software or documentation, and that the name of Intel Corporation not be used in advertising or publicity pertaining to distribution of the software or the documentation without specific, written prior permission.

Intel Corporation provides this AS IS, WITHOUT ANY WARRANTY, EXPRESS OR IMPLIED, INCLUDING, WITHOUT LIMITATION, ANY WARRANTY OF MERCHANTABILITY OR FITNESS FOR A PARTICULAR PURPOSE. Intel makes no

guarantee or representations regarding the use of, or the results of the use of, the software and documentation in terms of correctness, accuracy, reliability, currentness, or otherwise; and you rely on the software, documentation and results solely at your own risk.

IN NO EVENT SHALL INTEL BE LIABLE FOR ANY LOSS OF USE, LOSS OF BUSINESS, LOSS OF PROFITS, INDIRECT, INCIDENTAL, SPECIAL OR CONSEQUENTIAL DAMAGES OF ANY KIND. IN NO EVENT SHALL INTEL'S TOTAL LIABILITY EXCEED THE SUM PAID TO INTEL FOR THE PRODUCT LICENSED HEREUNDER.

24. Hewlett-Packard (hppa targets only)

© Copyright 1986 HEWLETT-PACKARD COMPANY

To anyone who acknowledges that this file is provided "AS IS" without any express or implied warranty: permission to use, copy, modify, and distribute this file for any purpose is hereby granted without fee, provided that the above copyright notice and this notice appears in all copies, and that the name of Hewlett-Packard Company not be used in advertising or publicity pertaining to distribution of the software without specific, written prior permission. Hewlett-Packard Company makes no representations about the suitability of this software for any purpose.

25. Henry Spencer (only *-linux targets)

Copyright 1992, 1993, 1994 Henry Spencer. All rights reserved.

This software is not subject to any license of the American Telephone and Telegraph Company or of the Regents of the University of California.

Permission is granted to anyone to use this software for any purpose on any computer system, and to alter it and redistribute it, subject to the following restrictions:

1. The author is not responsible for the consequences of use of this software, no matter how awful, even if they arise from flaws in it.
2. The origin of this software must not be misrepresented, either by explicit claim or by omission. Since few users ever read sources, credits must appear in the documentation.

3. Altered versions must be plainly marked as such, and must not be misrepresented as being the original software. Since few users ever read sources, credits must appear in the documentation.
4. This notice may not be removed or altered.

26. Mike Barcroft

Copyright © 2001 Mike Barcroft <mike@FreeBSD.org> All rights reserved.

Redistribution and use in source and binary forms, with or without modification, are permitted provided that the following conditions are met:

1. Redistributions of source code must retain the above copyright notice, this list of conditions and the following disclaimer.
2. Redistributions in binary form must reproduce the above copyright notice, this list of conditions and the following disclaimer in the documentation and/or other materials provided with the distribution.

THIS SOFTWARE IS PROVIDED BY THE AUTHOR AND CONTRIBUTORS ``AS IS'' AND ANY EXPRESS OR IMPLIED WARRANTIES, INCLUDING, BUT NOT LIMITED TO, THE IMPLIED WARRANTIES OF MERCHANTABILITY AND FITNESS FOR A PARTICULAR PURPOSE ARE DISCLAIMED. IN NO EVENT SHALL THE AUTHOR OR CONTRIBUTORS BE LIABLE FOR ANY DIRECT, INDIRECT, INCIDENTAL, SPECIAL, EXEMPLARY, OR CONSEQUENTIAL DAMAGES (INCLUDING, BUT NOT LIMITED TO, PROCUREMENT OF SUBSTITUTE GOODS OR SERVICES; LOSS OF USE, DATA, OR PROFITS; OR BUSINESS INTERRUPTION) HOWEVER CAUSED AND ON ANY THEORY OF LIABILITY, WHETHER IN CONTRACT, STRICT LIABILITY, OR TORT (INCLUDING NEGLIGENCE OR OTHERWISE) ARISING IN ANY WAY OUT OF THE USE OF THIS SOFTWARE, EVEN IF ADVISED OF THE POSSIBILITY OF SUCH DAMAGE.

27. Konstantin Chuguev (--enable-newlib-iconv)

Copyright © 1999, 2000 Konstantin Chuguev. All rights reserved.

Redistribution and use in source and binary forms, with or without modification, are permitted provided that the following conditions are met:

1. Redistributions of source code must retain the above copyright notice, this list of conditions and the following disclaimer.
2. Redistributions in binary form must reproduce the above copyright notice, this list of conditions and the following disclaimer in the documentation and/or other materials provided with the distribution.

THIS SOFTWARE IS PROVIDED BY THE AUTHOR AND CONTRIBUTORS ``AS IS'' AND ANY EXPRESS OR IMPLIED WARRANTIES, INCLUDING, BUT NOT LIMITED TO, THE IMPLIED WARRANTIES OF MERCHANTABILITY AND FITNESS FOR A PARTICULAR PURPOSE ARE DISCLAIMED. IN NO EVENT SHALL THE AUTHOR OR CONTRIBUTORS BE LIABLE FOR ANY DIRECT, INDIRECT, INCIDENTAL, SPECIAL, EXEMPLARY, OR CONSEQUENTIAL DAMAGES (INCLUDING, BUT NOT LIMITED TO, PROCUREMENT OF SUBSTITUTE GOODS OR SERVICES; LOSS OF USE, DATA, OR PROFITS; OR BUSINESS INTERRUPTION) HOWEVER CAUSED AND ON ANY THEORY OF LIABILITY, WHETHER IN CONTRACT, STRICT LIABILITY, OR TORT (INCLUDING NEGLIGENCE OR OTHERWISE) ARISING IN ANY WAY OUT OF THE USE OF THIS SOFTWARE, EVEN IF ADVISED OF THE POSSIBILITY OF SUCH DAMAGE.

iconv (Charset Conversion Library) v2.0

28. Artem Bityuckiy (--enable-newlib-iconv)

Copyright © 2003, Artem B. Bityuckiy, SoftMine Corporation.

Rights transferred to Franklin Electronic Publishers.

Redistribution and use in source and binary forms, with or without modification, are permitted provided that the following conditions are met:

1. Redistributions of source code must retain the above copyright notice, this list of conditions and the following disclaimer.
2. Redistributions in binary form must reproduce the above copyright notice, this list of conditions and the following disclaimer in the documentation and/or other materials provided with the distribution.

THIS SOFTWARE IS PROVIDED BY THE AUTHOR AND CONTRIBUTORS ``AS IS'' AND ANY EXPRESS OR IMPLIED WARRANTIES, INCLUDING, BUT NOT LIMITED TO, THE IMPLIED WARRANTIES OF MERCHANTABILITY AND FITNESS FOR A

PARTICULAR PURPOSE ARE DISCLAIMED. IN NO EVENT SHALL THE AUTHOR OR CONTRIBUTORS BE LIABLE FOR ANY DIRECT, INDIRECT, INCIDENTAL, SPECIAL, EXEMPLARY, OR CONSEQUENTIAL DAMAGES (INCLUDING, BUT NOT LIMITED TO, PROCUREMENT OF SUBSTITUTE GOODS OR SERVICES; LOSS OF USE, DATA, OR PROFITS; OR BUSINESS INTERRUPTION) HOWEVER CAUSED AND ON ANY THEORY OF LIABILITY, WHETHER IN CONTRACT, STRICT LIABILITY, OR TORT (INCLUDING NEGLIGENCE OR OTHERWISE) ARISING IN ANY WAY OUT OF THE USE OF THIS SOFTWARE, EVEN IF ADVISED OF THE POSSIBILITY OF SUCH DAMAGE.

29. IBM, Sony, Toshiba (only spu-* targets)

© Copyright 2001,2006, International Business Machines Corporation, Sony Computer Entertainment, Incorporated, Toshiba Corporation, All rights reserved.

Redistribution and use in source and binary forms, with or without modification, are permitted provided that the following conditions are met:

- Redistributions of source code must retain the above copyright notice, this list of conditions and the following disclaimer.
- Redistributions in binary form must reproduce the above copyright notice, this list of conditions and the following disclaimer in the documentation and/or other materials provided with the distribution.
- Neither the names of the copyright holders nor the names of their contributors may be used to endorse or promote products derived from this software without specific prior written permission.

THIS SOFTWARE IS PROVIDED BY THE COPYRIGHT HOLDERS AND CONTRIBUTORS "AS IS" AND ANY EXPRESS OR IMPLIED WARRANTIES, INCLUDING, BUT NOT LIMITED TO, THE IMPLIED WARRANTIES OF MERCHANTABILITY AND FITNESS FOR A PARTICULAR PURPOSE ARE DISCLAIMED. IN NO EVENT SHALL THE COPYRIGHT OWNER OR CONTRIBUTORS BE LIABLE FOR ANY DIRECT, INDIRECT, INCIDENTAL, SPECIAL, EXEMPLARY, OR CONSEQUENTIAL DAMAGES (INCLUDING, BUT NOT LIMITED TO, PROCUREMENT OF SUBSTITUTE GOODS OR SERVICES; LOSS OF USE, DATA, OR PROFITS; OR BUSINESS INTERRUPTION) HOWEVER CAUSED AND ON ANY THEORY OF LIABILITY, WHETHER IN CONTRACT, STRICT LIABILITY, OR TORT (INCLUDING

NEGLIGENCE OR OTHERWISE) ARISING IN ANY WAY OUT OF THE USE OF THIS SOFTWARE, EVEN IF ADVISED OF THE POSSIBILITY OF SUCH DAMAGE.

30. Alex Tatmanjants (targets using libc/posix)

Copyright © 1995 Alex Tatmanjants <alex@elvisti.kiev.ua> at Electronni Visti IA, Kiev, Ukraine. All rights reserved.

Redistribution and use in source and binary forms, with or without modification, are permitted provided that the following conditions are met:

1. Redistributions of source code must retain the above copyright notice, this list of conditions and the following disclaimer.
2. Redistributions in binary form must reproduce the above copyright notice, this list of conditions and the following disclaimer in the documentation and/or other materials provided with the distribution.

THIS SOFTWARE IS PROVIDED BY THE AUTHOR ``AS IS" AND ANY EXPRESS OR IMPLIED WARRANTIES, INCLUDING, BUT NOT LIMITED TO, THE IMPLIED WARRANTIES OF MERCHANTABILITY AND FITNESS FOR A PARTICULAR PURPOSE ARE DISCLAIMED. IN NO EVENT SHALL THE AUTHOR BE LIABLE FOR ANY DIRECT, INDIRECT, INCIDENTAL, SPECIAL, EXEMPLARY, OR CONSEQUENTIAL DAMAGES (INCLUDING, BUT NOT LIMITED TO, PROCUREMENT OF SUBSTITUTE GOODS OR SERVICES; LOSS OF USE, DATA, OR PROFITS; OR BUSINESS INTERRUPTION) HOWEVER CAUSED AND ON ANY THEORY OF LIABILITY, WHETHER IN CONTRACT, STRICT LIABILITY, OR TORT (INCLUDING NEGLIGENCE OR OTHERWISE) ARISING IN ANY WAY OUT OF THE USE OF THIS SOFTWARE, EVEN IF ADVISED OF THE POSSIBILITY OF SUCH DAMAGE.

31. M. Warner Losh (targets using libc/posix)

Copyright © 1998, M. Warner Losh <imp@freebsd.org> All rights reserved.

Redistribution and use in source and binary forms, with or without modification, are permitted provided that the following conditions are met:

1. Redistributions of source code must retain the above copyright notice, this list of conditions and the following disclaimer.

2. Redistributions in binary form must reproduce the above copyright notice, this list of conditions and the following disclaimer in the documentation and/or other materials provided with the distribution.

THIS SOFTWARE IS PROVIDED BY THE AUTHOR AND CONTRIBUTORS ``AS IS" AND ANY EXPRESS OR IMPLIED WARRANTIES, INCLUDING, BUT NOT LIMITED TO, THE IMPLIED WARRANTIES OF MERCHANTABILITY AND FITNESS FOR A PARTICULAR PURPOSE ARE DISCLAIMED. IN NO EVENT SHALL THE AUTHOR OR CONTRIBUTORS BE LIABLE FOR ANY DIRECT, INDIRECT, INCIDENTAL, SPECIAL, EXEMPLARY, OR CONSEQUENTIAL DAMAGES (INCLUDING, BUT NOT LIMITED TO, PROCUREMENT OF SUBSTITUTE GOODS OR SERVICES; LOSS OF USE, DATA, OR PROFITS; OR BUSINESS INTERRUPTION) HOWEVER CAUSED AND ON ANY THEORY OF LIABILITY, WHETHER IN CONTRACT, STRICT LIABILITY, OR TORT (INCLUDING NEGLIGENCE OR OTHERWISE) ARISING IN ANY WAY OUT OF THE USE OF THIS SOFTWARE, EVEN IF ADVISED OF THE POSSIBILITY OF SUCH DAMAGE.

32. Andrey A. Chernov (targets using libc/posix)

Copyright © 1996 by Andrey A. Chernov, Moscow, Russia. All rights reserved.

Redistribution and use in source and binary forms, with or without modification, are permitted provided that the following conditions are met:

1. Redistributions of source code must retain the above copyright notice, this list of conditions and the following disclaimer.
2. Redistributions in binary form must reproduce the above copyright notice, this list of conditions and the following disclaimer in the documentation and/or other materials provided with the distribution.

THIS SOFTWARE IS PROVIDED BY THE AUTHOR ``AS IS" AND ANY EXPRESS OR IMPLIED WARRANTIES, INCLUDING, BUT NOT LIMITED TO, THE IMPLIED WARRANTIES OF MERCHANTABILITY AND FITNESS FOR A PARTICULAR PURPOSE ARE DISCLAIMED. IN NO EVENT SHALL THE REGENTS OR CONTRIBUTORS BE LIABLE FOR ANY DIRECT, INDIRECT, INCIDENTAL, SPECIAL, EXEMPLARY, OR CONSEQUENTIAL DAMAGES (INCLUDING, BUT NOT LIMITED TO, PROCUREMENT OF SUBSTITUTE GOODS OR SERVICES; LOSS OF USE, DATA, OR PROFITS; OR BUSINESS INTERRUPTION) HOWEVER CAUSED AND ON

ANY THEORY OF LIABILITY, WHETHER IN CONTRACT, STRICT LIABILITY, OR TORT (INCLUDING NEGLIGENCE OR OTHERWISE) ARISING IN ANY WAY OUT OF THE USE OF THIS SOFTWARE, EVEN IF ADVISED OF THE POSSIBILITY OF SUCH DAMAGE.

33. Daniel Eischen (targets using libc/posix)

Copyright © 2001 Daniel Eischen <deischen@FreeBSD.org>. All rights reserved.

Redistribution and use in source and binary forms, with or without modification, are permitted provided that the following conditions are met:

1. Redistributions of source code must retain the above copyright notice, this list of conditions and the following disclaimer.
2. Redistributions in binary form must reproduce the above copyright notice, this list of conditions and the following disclaimer in the documentation and/or other materials provided with the distribution.

THIS SOFTWARE IS PROVIDED BY THE AUTHOR AND CONTRIBUTORS ``AS IS'' AND ANY EXPRESS OR IMPLIED WARRANTIES, INCLUDING, BUT NOT LIMITED TO, THE IMPLIED WARRANTIES OF MERCHANTABILITY AND FITNESS FOR A PARTICULAR PURPOSE ARE DISCLAIMED. IN NO EVENT SHALL THE REGENTS OR CONTRIBUTORS BE LIABLE FOR ANY DIRECT, INDIRECT, INCIDENTAL, SPECIAL, EXEMPLARY, OR CONSEQUENTIAL DAMAGES (INCLUDING, BUT NOT LIMITED TO, PROCUREMENT OF SUBSTITUTE GOODS OR SERVICES; LOSS OF USE, DATA, OR PROFITS; OR BUSINESS INTERRUPTION) HOWEVER CAUSED AND ON ANY THEORY OF LIABILITY, WHETHER IN CONTRACT, STRICT LIABILITY, OR TORT (INCLUDING NEGLIGENCE OR OTHERWISE) ARISING IN ANY WAY OUT OF THE USE OF THIS SOFTWARE, EVEN IF ADVISED OF THE POSSIBILITY OF SUCH DAMAGE.

34. Jon Beniston (only lm32-* targets)

Contributed by Jon Beniston <jon@beniston.com> Redistribution and use in source and binary forms, with or without modification, are permitted provided that the following conditions are met:

1. Redistributions of source code must retain the above copyright notice, this list of conditions and the following disclaimer.

2. Redistributions in binary form must reproduce the above copyright notice, this list of conditions and the following disclaimer in the documentation and/or other materials provided with the distribution.

THIS SOFTWARE IS PROVIDED BY THE AUTHOR AND CONTRIBUTORS ``AS IS" AND ANY EXPRESS OR IMPLIED WARRANTIES, INCLUDING, BUT NOT LIMITED TO, THE IMPLIED WARRANTIES OF MERCHANTABILITY AND FITNESS FOR A PARTICULAR PURPOSE ARE DISCLAIMED. IN NO EVENT SHALL THE AUTHOR OR CONTRIBUTORS BE LIABLE FOR ANY DIRECT, INDIRECT, INCIDENTAL, SPECIAL, EXEMPLARY, OR CONSEQUENTIAL DAMAGES (INCLUDING, BUT NOT LIMITED TO, PROCUREMENT OF SUBSTITUTE GOODS OR SERVICES; LOSS OF USE, DATA, OR PROFITS; OR BUSINESS INTERRUPTION) HOWEVER CAUSED AND ON ANY THEORY OF LIABILITY, WHETHER IN CONTRACT, STRICT LIABILITY, OR TORT (INCLUDING NEGLIGENCE OR OTHERWISE) ARISING IN ANY WAY OUT OF THE USE OF THIS SOFTWARE, EVEN IF ADVISED OF THE POSSIBILITY OF SUCH DAMAGE.

35. ARM Ltd (arm and thumb variant targets only)

Copyright © 2009 ARM Ltd All rights reserved.

Redistribution and use in source and binary forms, with or without modification, are permitted provided that the following conditions are met:

1. Redistributions of source code must retain the above copyright notice, this list of conditions and the following disclaimer.
2. Redistributions in binary form must reproduce the above copyright notice, this list of conditions and the following disclaimer in the documentation and/or other materials provided with the distribution.
3. The name of the company may not be used to endorse or promote products derived from this software without specific prior written permission.

THIS SOFTWARE IS PROVIDED BY ARM LTD ``AS IS" AND ANY EXPRESS OR IMPLIED WARRANTIES, INCLUDING, BUT NOT LIMITED TO, THE IMPLIED WARRANTIES OF MERCHANTABILITY AND FITNESS FOR A PARTICULAR PURPOSE ARE DISCLAIMED. IN NO EVENT SHALL ARM LTD BE LIABLE FOR ANY DIRECT, INDIRECT, INCIDENTAL, SPECIAL, EXEMPLARY, OR CONSEQUENTIAL DAMAGES (INCLUDING, BUT NOT LIMITED TO, PROCUREMENT OF SUBSTITUTE

GOODS OR SERVICES; LOSS OF USE, DATA, OR PROFITS; OR BUSINESS INTERRUPTION) HOWEVER CAUSED AND ON ANY THEORY OF LIABILITY, WHETHER IN CONTRACT, STRICT LIABILITY, OR TORT (INCLUDING NEGLIGENCE OR OTHERWISE) ARISING IN ANY WAY OUT OF THE USE OF THIS SOFTWARE, EVEN IF ADVISED OF THE POSSIBILITY OF SUCH DAMAGE.

36. Xilinx, Inc. (microblaze-* and powerpc-* targets)

Copyright © 2004, 2009 Xilinx, Inc. All rights reserved.

Redistribution and use in source and binary forms, with or without modification, are permitted provided that the following conditions are met:

1. Redistributions source code must retain the above copyright notice, this list of conditions and the following disclaimer.
2. Redistributions in binary form must reproduce the above copyright notice, this list of conditions and the following disclaimer in the documentation and/or other materials provided with the distribution.
3. Neither the name of Xilinx nor the names of its contributors may be used to endorse or promote products derived from this software without specific prior written permission.

THIS SOFTWARE IS PROVIDED BY THE COPYRIGHT HOLDER AND CONTRIBUTORS "AS IS" AND ANY EXPRESS OR IMPLIED WARRANTIES, INCLUDING, BUT NOT LIMITED TO, THE IMPLIED WARRANTIES OF MERCHANTABILITY AND FITNESS FOR A PARTICULAR PURPOSE ARE DISCLAIMED. IN NO EVENT SHALL THE COPYRIGHT HOLDER OR CONTRIBUTORS BE LIABLE FOR ANY DIRECT, INDIRECT, INCIDENTAL, SPECIAL, EXEMPLARY, OR CONSEQUENTIAL DAMAGES (INCLUDING, BUT NOT LIMITED TO, PROCUREMENT OF SUBSTITUTE GOODS OR SERVICES; LOSS OF USE, DATA, OR PROFITS; OR BUSINESS INTERRUPTION) HOWEVER CAUSED AND ON ANY THEORY OF LIABILITY, WHETHER IN CONTRACT, STRICT LIABILITY, OR TORT (INCLUDING NEGLIGENCE OR OTHERWISE) ARISING IN ANY WAY OUT OF THE USE OF THIS SOFTWARE, EVEN IF ADVISED OF THE POSSIBILITY OF SUCH DAMAGE.

37. Texas Instruments Incorporated (tic6x-*, *-tirtos targets)

Copyright © 1996-2010,2014 Texas Instruments Incorporated

<http://www.ti.com/>

Redistribution and use in source and binary forms, with or without modification, are permitted provided that the following conditions are met:

1. Redistributions of source code must retain the above copyright notice, this list of conditions and the following disclaimer.
2. Redistributions in binary form must reproduce the above copyright notice, this list of conditions and the following disclaimer in the documentation and/or other materials provided with the distribution.
3. Neither the name of Texas Instruments Incorporated nor the names of its contributors may be used to endorse or promote products derived from this software without specific prior written permission.

THIS SOFTWARE IS PROVIDED BY THE COPYRIGHT HOLDERS AND CONTRIBUTORS "AS IS" AND ANY EXPRESS OR IMPLIED WARRANTIES, INCLUDING, BUT NOT LIMITED TO, THE IMPLIED WARRANTIES OF MERCHANTABILITY AND FITNESS FOR A PARTICULAR PURPOSE ARE DISCLAIMED. IN NO EVENT SHALL THE COPYRIGHT OWNER OR CONTRIBUTORS BE LIABLE FOR ANY DIRECT, INDIRECT, INCIDENTAL, SPECIAL, EXEMPLARY, OR CONSEQUENTIAL DAMAGES (INCLUDING, BUT NOT LIMITED TO, PROCUREMENT OF SUBSTITUTE GOODS OR SERVICES; LOSS OF USE, DATA, OR PROFITS; OR BUSINESS INTERRUPTION) HOWEVER CAUSED AND ON ANY THEORY OF LIABILITY, WHETHER IN CONTRACT, STRICT LIABILITY, OR TORT (INCLUDING NEGLIGENCE OR OTHERWISE) ARISING IN ANY WAY OUT OF THE USE OF THIS SOFTWARE, EVEN IF ADVISED OF THE POSSIBILITY OF SUCH DAMAGE.

38. National Semiconductor (cr16-* and crx-* targets)

Copyright (c) 2004 National Semiconductor Corporation

The authors hereby grant permission to use, copy, modify, distribute, and license this software and its documentation for any purpose, provided that existing copyright notices are retained in all copies and that this notice is included verbatim in any distributions. No written agreement, license, or royalty fee is required for any of the authorized uses. Modifications to this software may be copyrighted by their authors and need not follow the licensing terms described here, provided that the new terms are clearly indicated on the first page of each file where they apply.

39. Adapteva, Inc. (epiphany-* targets)

Copyright © 2011, Adapteva, Inc. All rights reserved.

Redistribution and use in source and binary forms, with or without modification, are permitted provided that the following conditions are met:

- Redistributions of source code must retain the above copyright notice, this list of conditions and the following disclaimer.
- Redistributions in binary form must reproduce the above copyright notice, this list of conditions and the following disclaimer in the documentation and/or other materials provided with the distribution.
- Neither the name of Adapteva nor the names of its contributors may be used to endorse or promote products derived from this software without specific prior written permission.

THIS SOFTWARE IS PROVIDED BY THE COPYRIGHT HOLDERS AND CONTRIBUTORS "AS IS" AND ANY EXPRESS OR IMPLIED WARRANTIES, INCLUDING, BUT NOT LIMITED TO, THE IMPLIED WARRANTIES OF MERCHANTABILITY AND FITNESS FOR A PARTICULAR PURPOSE ARE DISCLAIMED. IN NO EVENT SHALL THE COPYRIGHT HOLDER OR CONTRIBUTORS BE LIABLE FOR ANY DIRECT, INDIRECT, INCIDENTAL, SPECIAL, EXEMPLARY, OR CONSEQUENTIAL DAMAGES (INCLUDING, BUT NOT LIMITED TO, PROCUREMENT OF SUBSTITUTE GOODS OR SERVICES; LOSS OF USE, DATA, OR PROFITS; OR BUSINESS INTERRUPTION) HOWEVER CAUSED AND ON ANY THEORY OF LIABILITY, WHETHER IN CONTRACT, STRICT LIABILITY, OR TORT (INCLUDING NEGLIGENCE OR OTHERWISE) ARISING IN ANY WAY OUT OF THE USE OF THIS SOFTWARE, EVEN IF ADVISED OF THE POSSIBILITY OF SUCH DAMAGE.

40. Altera Corporation (nios2-* targets)

Copyright © 2003 Altera Corporation All rights reserved.

Redistribution and use in source and binary forms, with or without modification, are permitted provided that the following conditions are met:

- Redistributions of source code must retain the above copyright notice, this list of conditions and the following disclaimer.

- Redistributions in binary form must reproduce the above copyright notice, this list of conditions and the following disclaimer in the documentation and/or other materials provided with the distribution.
- Neither the name of Altera Corporation nor the names of its contributors may be used to endorse or promote products derived from this software without specific prior written permission.

THIS SOFTWARE IS PROVIDED BY ALTERA CORPORATION, THE COPYRIGHT HOLDER, AND ITS CONTRIBUTORS "AS IS" AND ANY EXPRESS OR IMPLIED WARRANTIES, INCLUDING, BUT NOT LIMITED TO, THE IMPLIED WARRANTIES OF MERCHANTABILITY AND FITNESS FOR A PARTICULAR PURPOSE ARE DISCLAIMED. IN NO EVENT SHALL THE COPYRIGHT HOLDER OR CONTRIBUTORS BE LIABLE FOR ANY DIRECT, INDIRECT, INCIDENTAL, SPECIAL, EXEMPLARY, OR CONSEQUENTIAL DAMAGES (INCLUDING, BUT NOT LIMITED TO, PROCUREMENT OF SUBSTITUTE GOODS OR SERVICES; LOSS OF USE, DATA, OR PROFITS; OR BUSINESS INTERRUPTION) HOWEVER CAUSED AND ON ANY THEORY OF LIABILITY, WHETHER IN CONTRACT, STRICT LIABILITY, OR TORT (INCLUDING NEGLIGENCE OR OTHERWISE) ARISING IN ANY WAY OUT OF THE USE OF THIS SOFTWARE, EVEN IF ADVISED OF THE POSSIBILITY OF SUCH DAMAGE.

41. Ed Schouten - Free BSD

Copyright © 2008 Ed Schouten <ed@FreeBSD.org> All rights reserved.

Redistribution and use in source and binary forms, with or without modification, are permitted provided that the following conditions are met:

1. Redistributions of source code must retain the above copyright notice, this list of conditions and the following disclaimer.
2. Redistributions in binary form must reproduce the above copyright notice, this list of conditions and the following disclaimer in the documentation and/or other materials provided with the distribution.

THIS SOFTWARE IS PROVIDED BY THE AUTHOR AND CONTRIBUTORS ``AS IS'' AND ANY EXPRESS OR IMPLIED WARRANTIES, INCLUDING, BUT NOT LIMITED TO, THE IMPLIED WARRANTIES OF MERCHANTABILITY AND FITNESS FOR A PARTICULAR PURPOSE ARE DISCLAIMED. IN NO EVENT SHALL THE AUTHOR OR CONTRIBUTORS BE LIABLE FOR ANY DIRECT, INDIRECT, INCIDENTAL,

SPECIAL, EXEMPLARY, OR CONSEQUENTIAL DAMAGES (INCLUDING, BUT NOT LIMITED TO, PROCUREMENT OF SUBSTITUTE GOODS OR SERVICES; LOSS OF USE, DATA, OR PROFITS; OR BUSINESS INTERRUPTION) HOWEVER CAUSED AND ON ANY THEORY OF LIABILITY, WHETHER IN CONTRACT, STRICT LIABILITY, OR TORT (INCLUDING NEGLIGENCE OR OTHERWISE) ARISING IN ANY WAY OUT OF THE USE OF THIS SOFTWARE, EVEN IF ADVISED OF THE POSSIBILITY OF SUCH DAMAGE.

II. Xtensa header files

Copyright (c) 2001-2014 Cadence Design Systems, Inc.

Permission is hereby granted, free of charge, to any person obtaining a copy of this software and associated documentation files (the "Software"), to deal in the Software without restriction, including without limitation the rights to use, copy, modify, merge, publish, distribute, sublicense, and/or sell copies of the Software, and to permit persons to whom the Software is furnished to do so, subject to the following conditions:

The above copyright notice and this permission notice shall be included in all copies or substantial portions of the Software.

THE SOFTWARE IS PROVIDED "AS IS", WITHOUT WARRANTY OF ANY KIND, EXPRESS OR IMPLIED, INCLUDING BUT NOT LIMITED TO THE WARRANTIES OF MERCHANTABILITY, FITNESS FOR A PARTICULAR PURPOSE AND NONINFRINGEMENT. IN NO EVENT SHALL THE AUTHORS OR COPYRIGHT HOLDERS BE LIABLE FOR ANY CLAIM, DAMAGES OR OTHER LIABILITY, WHETHER IN AN ACTION OF CONTRACT, TORT OR OTHERWISE, ARISING FROM, OUT OF OR IN CONNECTION WITH THE SOFTWARE OR THE USE OR OTHER DEALINGS IN THE SOFTWARE.

III. Original parts of FreeRTOS

MIT License

Permission is hereby granted, free of charge, to any person obtaining a copy of this software and associated documentation files (the "Software"), to deal in the Software without restriction, including without limitation the rights to use, copy, modify, merge, publish, distribute, sublicense, and/or sell copies of the Software, and to permit persons to

whom the Software is furnished to do so, subject to the following conditions:

The above copyright notice and this permission notice shall be included in all copies or substantial portions of the Software.

THE SOFTWARE IS PROVIDED "AS IS", WITHOUT WARRANTY OF ANY KIND, EXPRESS OR IMPLIED, INCLUDING BUT NOT LIMITED TO THE WARRANTIES OF MERCHANTABILITY, FITNESS FOR A PARTICULAR PURPOSE AND NONINFRINGEMENT. IN NO EVENT SHALL THE AUTHORS OR COPYRIGHT HOLDERS BE LIABLE FOR ANY CLAIM, DAMAGES OR OTHER LIABILITY, WHETHER IN AN ACTION OF CONTRACT, TORT OR OTHERWISE, ARISING FROM, OUT OF OR IN CONNECTION WITH THE SOFTWARE OR THE USE OR OTHER DEALINGS IN THE SOFTWARE.

IV. FatFS library

Copyright © 2018, ChaN, all right reserved.

FatFs module is an open source software. Redistribution and use of FatFs in source and binary forms, with or without modification, are permitted provided that the following condition is met:

1. Redistributions of source code must retain the above copyright notice, this condition and the following disclaimer.

This software is provided by the copyright holder and contributors "AS IS" and any warranties related to this software are DISCLAIMED.

The copyright owner or contributors be NOT LIABLE for any damages caused by use of this software.

V. SPIFFS library

The MIT License (MIT)

Copyright © 2013-2017 Peter Andersson (pelleplutt1976<at>gmail.com)

Permission is hereby granted, free of charge, to any person obtaining a copy of this software and associated documentation files (the "Software"), to deal in the Software without restriction, including without limitation the rights to use, copy, modify, merge, publish, distribute,

sublicense, and/or sell copies of the Software, and to permit persons to whom the Software is furnished to do so, subject to the following conditions:

The above copyright notice and this permission notice shall be included in all copies or substantial portions of the Software.

THE SOFTWARE IS PROVIDED "AS IS", WITHOUT WARRANTY OF ANY KIND, EXPRESS OR IMPLIED, INCLUDING BUT NOT LIMITED TO THE WARRANTIES OF MERCHANTABILITY, FITNESS FOR A PARTICULAR PURPOSE AND NONINFRINGEMENT. IN NO EVENT SHALL THE AUTHORS OR COPYRIGHT HOLDERS BE LIABLE FOR ANY CLAIM, DAMAGES OR OTHER LIABILITY, WHETHER IN AN ACTION OF CONTRACT, TORT OR OTHERWISE, ARISING FROM, OUT OF OR IN CONNECTION WITH THE SOFTWARE OR THE USE OR OTHER DEALINGS IN THE SOFTWARE.

VI. TLSF allocator Two Level Segregated Fit memory allocator

Copyright © 2006-2016, Matthew Conte All rights reserved.

Redistribution and use in source and binary forms, with or without modification, are permitted provided that the following conditions are met:

- Redistributions of source code must retain the above copyright notice, this list of conditions and the following disclaimer.
- Redistributions in binary form must reproduce the above copyright notice, this list of conditions and the following disclaimer in the documentation and/or other materials provided with the distribution.
- Neither the name of the copyright holder nor the names of its contributors may be used to endorse or promote products derived from this software without specific prior written permission.

THIS SOFTWARE IS PROVIDED BY THE COPYRIGHT HOLDERS AND CONTRIBUTORS "AS IS" AND ANY EXPRESS OR IMPLIED WARRANTIES, INCLUDING, BUT NOT LIMITED TO, THE IMPLIED WARRANTIES OF MERCHANTABILITY AND FITNESS FOR A PARTICULAR PURPOSE ARE DISCLAIMED. IN NO EVENT SHALL MATTHEW CONTE BE LIABLE FOR ANY DIRECT, INDIRECT, INCIDENTAL, SPECIAL, EXEMPLARY, OR CONSEQUENTIAL DAMAGES (INCLUDING, BUT NOT LIMITED TO, PROCUREMENT OF SUBSTITUTE GOODS OR

SERVICES; LOSS OF USE, DATA, OR PROFITS; OR BUSINESS INTERRUPTION) HOWEVER CAUSED AND ON ANY THEORY OF LIABILITY, WHETHER IN CONTRACT, STRICT LIABILITY, OR TORT (INCLUDING NEGLIGENCE OR OTHERWISE) ARISING IN ANY WAY OUT OF THE USE OF THIS SOFTWARE, EVEN IF ADVISED OF THE POSSIBILITY OF SUCH DAMAGE.

VII. HTTP Parser Based on src/http/nginx_http_parse.c

Based on src/http/nginx_http_parse.c from NGINX copyright Igor Sysoev

Additional changes are licensed under the same terms as NGINX and copyright Joyent, Inc. and other Node contributors. All rights reserved.

Permission is hereby granted, free of charge, to any person obtaining a copy of this software and associated documentation files (the "Software"), to deal in the Software without restriction, including without limitation the rights to use, copy, modify, merge, publish, distribute, sublicense, and/or sell copies of the Software, and to permit persons to whom the Software is furnished to do so, subject to the following conditions:

The above copyright notice and this permission notice shall be included in all copies or substantial portions of the Software.

THE SOFTWARE IS PROVIDED "AS IS", WITHOUT WARRANTY OF ANY KIND, EXPRESS OR IMPLIED, INCLUDING BUT NOT LIMITED TO THE WARRANTIES OF MERCHANTABILITY, FITNESS FOR A PARTICULAR PURPOSE AND NONINFRINGEMENT. IN NO EVENT SHALL THE AUTHORS OR COPYRIGHT HOLDERS BE LIABLE FOR ANY CLAIM, DAMAGES OR OTHER LIABILITY, WHETHER IN AN ACTION OF CONTRACT, TORT OR OTHERWISE, ARISING FROM, OUT OF OR IN CONNECTION WITH THE SOFTWARE OR THE USE OR OTHER DEALINGS IN THE SOFTWARE.

VIII. miniz

Copyright 2013-2014 RAD Game Tools and Valve Software

Copyright 2010-2014 Rich Geldreich and Tenacious Software LLC

All Rights Reserved.

Permission is hereby granted, free of charge, to any person obtaining a copy of this software and associated documentation files (the "Software"), to deal in the Software without restriction, including without limitation the rights to use, copy, modify, merge, publish, distribute, sublicense, and/or sell copies of the Software, and to permit persons to whom the Software is furnished to do so, subject to the following conditions:

The above copyright notice and this permission notice shall be included in all copies or substantial portions of the Software.

THE SOFTWARE IS PROVIDED "AS IS", WITHOUT WARRANTY OF ANY KIND, EXPRESS OR IMPLIED, INCLUDING BUT NOT LIMITED TO THE WARRANTIES OF MERCHANTABILITY, FITNESS FOR A PARTICULAR PURPOSE AND NONINFRINGEMENT. IN NO EVENT SHALL THE AUTHORS OR COPYRIGHT HOLDERS BE LIABLE FOR ANY CLAIM, DAMAGES OR OTHER LIABILITY, WHETHER IN AN ACTION OF CONTRACT, TORT OR OTHERWISE, ARISING FROM, OUT OF OR IN CONNECTION WITH THE SOFTWARE OR THE USE OR OTHER DEALINGS IN THE SOFTWARE.

IX. tinyuf2

Copyright (c) 2020 Ha Thach

Permission is hereby granted, free of charge, to any person obtaining a copy of this software and associated documentation files (the "Software"), to deal in the Software without restriction, including without limitation the rights to use, copy, modify, merge, publish, distribute, sublicense, and/or sell copies of the Software, and to permit persons to whom the Software is furnished to do so, subject to the following conditions:

The above copyright notice and this permission notice shall be included in all copies or substantial portions of the Software.

THE SOFTWARE IS PROVIDED "AS IS", WITHOUT WARRANTY OF ANY KIND, EXPRESS OR IMPLIED, INCLUDING BUT NOT LIMITED TO THE WARRANTIES OF MERCHANTABILITY, FITNESS FOR A PARTICULAR PURPOSE AND NONINFRINGEMENT. IN NO EVENT SHALL THE AUTHORS OR COPYRIGHT HOLDERS BE LIABLE FOR ANY CLAIM, DAMAGES OR OTHER LIABILITY, WHETHER IN AN

ACTION OF CONTRACT, TORT OR OTHERWISE, ARISING FROM, OUT OF OR IN CONNECTION WITH THE SOFTWARE OR THE USE OR OTHER DEALINGS IN THE SOFTWARE.

X. cJSON

Copyright (c) 2009-2017 Dave Gamble and cJSON contributors

Permission is hereby granted, free of charge, to any person obtaining a copy of this software and associated documentation files (the "Software"), to deal in the Software without restriction, including without limitation the rights to use, copy, modify, merge, publish, distribute, sublicense, and/or sell copies of the Software, and to permit persons to whom the Software is furnished to do so, subject to the following conditions:

The above copyright notice and this permission notice shall be included in all copies or substantial portions of the Software.

THE SOFTWARE IS PROVIDED "AS IS", WITHOUT WARRANTY OF ANY KIND, EXPRESS OR IMPLIED, INCLUDING BUT NOT LIMITED TO THE WARRANTIES OF MERCHANTABILITY, FITNESS FOR A PARTICULAR PURPOSE AND NONINFRINGEMENT. IN NO EVENT SHALL THE AUTHORS OR COPYRIGHT HOLDERS BE LIABLE FOR ANY CLAIM, DAMAGES OR OTHER LIABILITY, WHETHER IN AN ACTION OF CONTRACT, TORT OR OTHERWISE, ARISING FROM, OUT OF OR IN CONNECTION WITH THE SOFTWARE OR THE USE OR OTHER DEALINGS IN THE SOFTWARE.

XI. Xtensa libhal

Copyright (c) 2003, 2006, 2010 Tensilica Inc.

Permission is hereby granted, free of charge, to any person obtaining a copy of this software and associated documentation files (the "Software"), to deal in the Software without restriction, including without limitation the rights to use, copy, modify, merge, publish, distribute, sublicense, and/or sell copies of the Software, and to permit persons to whom the Software is furnished to do so, subject to the following conditions:

The above copyright notice and this permission notice shall be included in all copies or substantial portions of the Software.

THE SOFTWARE IS PROVIDED "AS IS", WITHOUT WARRANTY OF ANY KIND, EXPRESS OR IMPLIED, INCLUDING BUT NOT LIMITED TO THE WARRANTIES OF MERCHANTABILITY, FITNESS FOR A PARTICULAR PURPOSE AND NONINFRINGEMENT. IN NO EVENT SHALL THE AUTHORS OR COPYRIGHT HOLDERS BE LIABLE FOR ANY CLAIM, DAMAGES OR OTHER LIABILITY, WHETHER IN AN ACTION OF CONTRACT, TORT OR OTHERWISE, ARISING FROM, OUT OF OR IN CONNECTION WITH THE SOFTWARE OR THE USE OR OTHER DEALINGS IN THE SOFTWARE.

XII. TinyBasic Plus

Copyright (c) 2012-2013

Permission is hereby granted, free of charge, to any person obtaining a copy of this software and associated documentation files (the "Software"), to deal in the Software without restriction, including without limitation the rights to use, copy, modify, merge, publish, distribute, sublicense, and/or sell copies of the Software, and to permit persons to whom the Software is furnished to do so, subject to the following conditions:

The above copyright notice and this permission notice shall be included in all copies or substantial portions of the Software.

THE SOFTWARE IS PROVIDED "AS IS", WITHOUT WARRANTY OF ANY KIND, EXPRESS OR IMPLIED, INCLUDING BUT NOT LIMITED TO THE WARRANTIES OF MERCHANTABILITY, FITNESS FOR A PARTICULAR PURPOSE AND NONINFRINGEMENT. IN NO EVENT SHALL THE AUTHORS OR COPYRIGHT HOLDERS BE LIABLE FOR ANY CLAIM, DAMAGES OR OTHER LIABILITY, WHETHER IN AN ACTION OF CONTRACT, TORT OR OTHERWISE, ARISING FROM, OUT OF OR IN CONNECTION WITH THE SOFTWARE OR THE USE OR OTHER DEALINGS IN THE SOFTWARE.

XIII. wpa_suppliant

Copyright (c) 2003-2022, Jouni Malinen <j@w1.fi> and contributors

All Rights Reserved.

This software may be distributed, used, and modified under the terms of BSD license:

Redistribution and use in source and binary forms, with or without modification, are permitted provided that the following conditions are met:

1. Redistributions of source code must retain the above copyright notice, this list of conditions and the following disclaimer.
2. Redistributions in binary form must reproduce the above copyright notice, this list of conditions and the following disclaimer in the documentation and/or other materials provided with the distribution.
3. Neither the name(s) of the above-listed copyright holder(s) nor the names of its contributors may be used to endorse or promote products derived from this software without specific prior written permission.

THIS SOFTWARE IS PROVIDED BY THE COPYRIGHT HOLDERS AND CONTRIBUTORS "AS IS" AND ANY EXPRESS OR IMPLIED WARRANTIES, INCLUDING, BUT NOT LIMITED TO, THE IMPLIED WARRANTIES OF MERCHANTABILITY AND FITNESS FOR A PARTICULAR PURPOSE ARE DISCLAIMED. IN NO EVENT SHALL THE COPYRIGHT OWNER OR CONTRIBUTORS BE LIABLE FOR ANY DIRECT, INDIRECT, INCIDENTAL, SPECIAL, EXEMPLARY, OR CONSEQUENTIAL DAMAGES (INCLUDING, BUT NOT LIMITED TO, PROCUREMENT OF SUBSTITUTE GOODS OR SERVICES; LOSS OF USE, DATA, OR PROFITS; OR BUSINESS INTERRUPTION) HOWEVER CAUSED AND ON ANY THEORY OF LIABILITY, WHETHER IN CONTRACT, STRICT LIABILITY, OR TORT (INCLUDING NEGLIGENCE OR OTHERWISE) ARISING IN ANY WAY OUT OF THE USE OF THIS SOFTWARE, EVEN IF ADVISED OF THE POSSIBILITY OF SUCH DAMAGE.

XIV. TjpgDec

Copyright (C) 2011, ChaN, all right reserved.

The TjpgDec module is a free software and there is NO WARRANTY.

No restriction on use. You can use, modify and redistribute it for personal, non-profit or commercial products UNDER YOUR RESPONSIBILITY.

Redistributions of source code must retain the above copyright notice.

XV. tinyusb

Copyright (c) 2018, hathach (tinyusb.org)

Permission is hereby granted, free of charge, to any person obtaining a copy of this software and associated documentation files (the "Software"), to deal in the Software without restriction, including without limitation the rights to use, copy, modify, merge, publish, distribute, sublicense, and/or sell copies of the Software, and to permit persons to whom the Software is furnished to do so, subject to the following conditions:

The above copyright notice and this permission notice shall be included in all copies or substantial portions of the Software.

THE SOFTWARE IS PROVIDED "AS IS", WITHOUT WARRANTY OF ANY KIND, EXPRESS OR IMPLIED, INCLUDING BUT NOT LIMITED TO THE WARRANTIES OF MERCHANTABILITY, FITNESS FOR A PARTICULAR PURPOSE AND NONINFRINGEMENT. IN NO EVENT SHALL THE AUTHORS OR COPYRIGHT HOLDERS BE LIABLE FOR ANY CLAIM, DAMAGES OR OTHER LIABILITY, WHETHER IN AN ACTION OF CONTRACT, TORT OR OTHERWISE, ARISING FROM, OUT OF OR IN CONNECTION WITH THE SOFTWARE OR THE USE OR OTHER DEALINGS IN THE SOFTWARE.

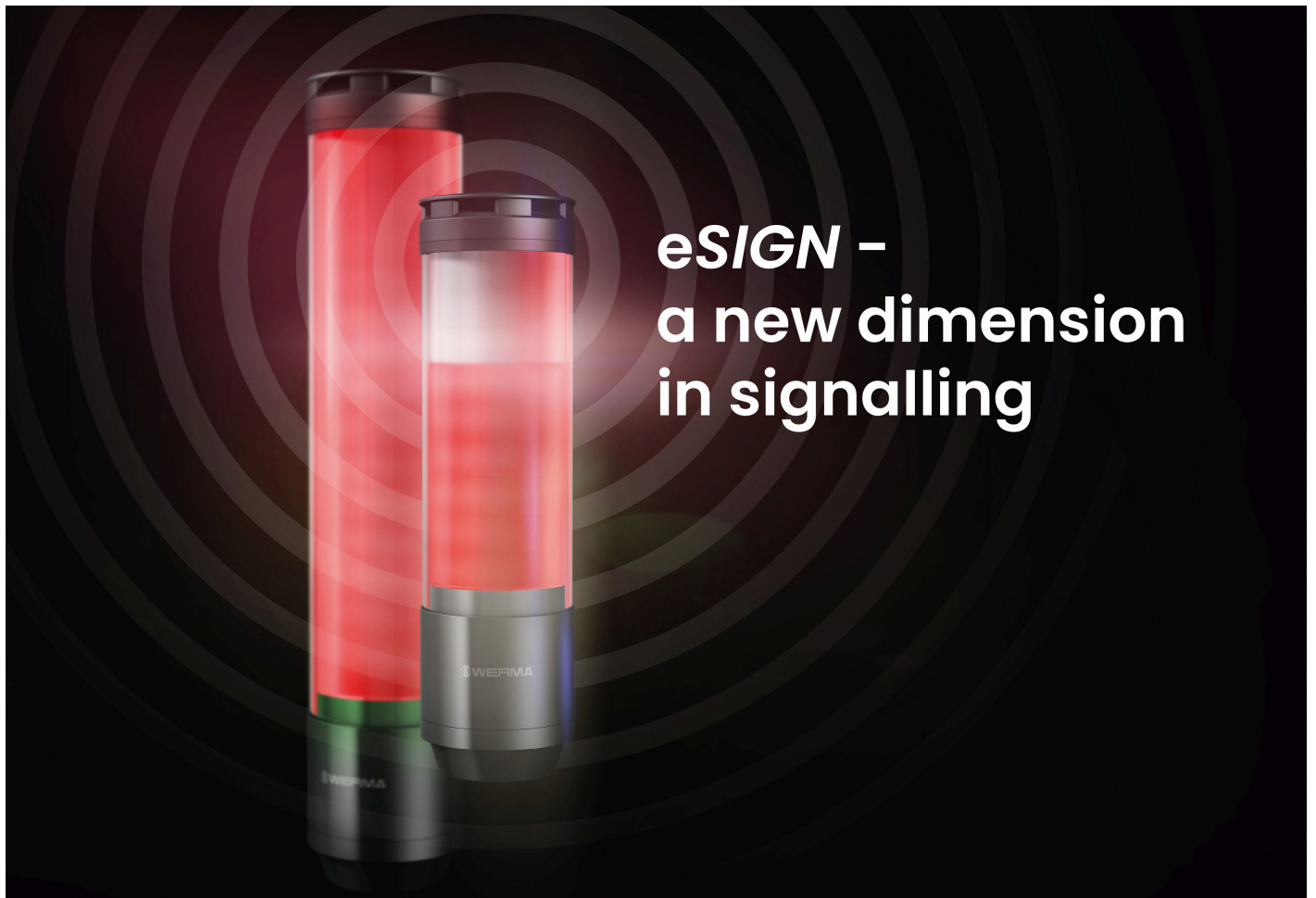

Manual

eSIGN 24 V

Functional description of the signal tower with configuration software

Version: 2.0 - 06/2022

310.657.006

Legal notice

Any mention of company names is solely for instruction purposes. Reference to existing organisations is not intended, except for the companies below. The following companies and brands are mentioned in the Manual:

- Microsoft and Windows 10 are trademarks of the Microsoft Corporation

WERMA reserves the right to make technical changes to the product and accepts no responsibility for any mistakes or printing errors in this documentation.

© Copyright 2022, WERMA Signaltechnik GmbH + Co.KG.

All rights reserved.

WERMA Signaltechnik GmbH + Co.KG

78604 Riethem-Weilheim, Germany

Phone: +49 (0)7424 / 9557-222

Fax: +49 (0)7424 / 9557-44

support@werma.com

www.werma.com

Table of contents

1 Overview	109
1.1 Function	109
1.2 Hardware description	109
1.2.1 Overview of the connection area	110
1.2.2 Overview of the 8-pin M12 connector	111
1.3 System requirements for the eSIGN configuration software	111
2 Installing the eSIGN configuration software	112
3 Starting the eSIGN configuration software	112
3.1 Overview	113
3.1.1 Configuration Area	114
3.1.2 Device Information Area	114
3.1.3 Support Area	114
3.1.4 This Software Area	114
3.1.5 Firmware Area	114
3.2 Setting the language	114
4 Creating a new configuration	115
4.1 Autoscale mode	117
4.1.1 Selecting the eSIGN variant	118
4.1.2 Adding or removing a tier	119
4.1.3 Moving a tier	119
4.1.4 Selecting a colour	120
4.1.5 Selecting a light effect	121
4.1.6 Setting the brightness	122
4.1.7 Selecting the siren	122
4.1.8 Selecting a pin	124
4.1.9 Simulating signal inputs	125
4.1.10 Finalising the configuration	126
4.2 Signal tower mode	127
4.2.1 Selecting the eSIGN variant	128
4.2.2 Adding or removing a tier	128
4.2.3 Moving a tier	129
4.2.4 Selecting a colour	129
4.2.5 Selecting a light effect	131
4.2.6 Setting the brightness	131
4.2.7 Selecting the siren	132
4.2.8 Selecting a pin	134
4.2.9 Simulating signal inputs	135
4.2.10 Finalising the configuration	136

4.3	Filling Level mode	137
4.3.1	Selecting the eSIGN variant	137
4.3.2	Selecting the number of signal combinations	138
4.3.3	Selecting a colour	139
4.3.4	Configuring the filling level indicator	142
4.3.5	Simulating signal inputs	150
4.3.6	Finalising the configuration	150
4.4	Individual mode	151
4.4.1	Selecting the eSIGN variant	151
4.4.2	Configuring signal effects	152
4.4.3	Selecting a pin	160
4.4.4	Duplicating the signal effect	161
4.4.5	Adding a signal effect	162
4.4.6	Deleting a signal effect	162
4.4.7	Simulating signal inputs	162
4.4.8	Finalising the configuration	163
5	Creating a configuration from sample templates	164
6	Loading the configuration of the connected eSIGN	166
7	Opening the existing configuration	167
8	Updating eSIGN configuration software	168
9	Updating the firmware	169
10	Support	170
	Werma eSIGN - OSS-Licence agreements	171

1 Overview

1.1 Function

The new *eSIGN* brings new dimensions to light. Electronic modularity enables the product to create a variety of signal modes with various colours, brightness levels and light effects, from the classic signal tower to completely customised settings. *eSIGN* can also switch with ease between variable filling level indications or full-surface signalling. In addition to providing you with an overview of your process cycles, this also opens up completely new options.

The WERMA *eSIGN* configuration software can be used to configure the individual segments and to transfer the configuration to the *eSIGN*.

The configuration can be performed with or without connecting an *eSIGN*. If no *eSIGN* is connected, the configuration can be saved in a configuration file and later loaded and transferred to a connected *eSIGN*.

1.2 Hardware description

The hardware information applies to the following part numbers:

- 657.000.55 - 9 segments
- 657.100.55 - 9 segments with siren
- 657.500.55 - 15 segments
- 657.600.55 - 15 segments with siren

1.2.1 Overview of the connection area

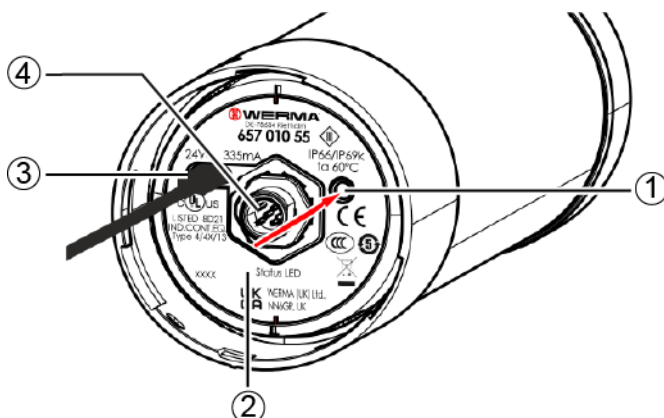

Item	Description
1	User button
2	Status LED
3	USB-C connection
4	8-pin M12 connector

LED status	Description
LED flashes yellow	Normal operation
LED pulses	Firmware update is being installed
LED is off	USB-C cable not properly connected

i The user button is not functional in the current eSIGN version and is kept available for future functional enhancements.

1.2.2 Overview of the 8-pin M12 connector

The eSIGN is connected via an 8-pin M12 connector with the following assignment:

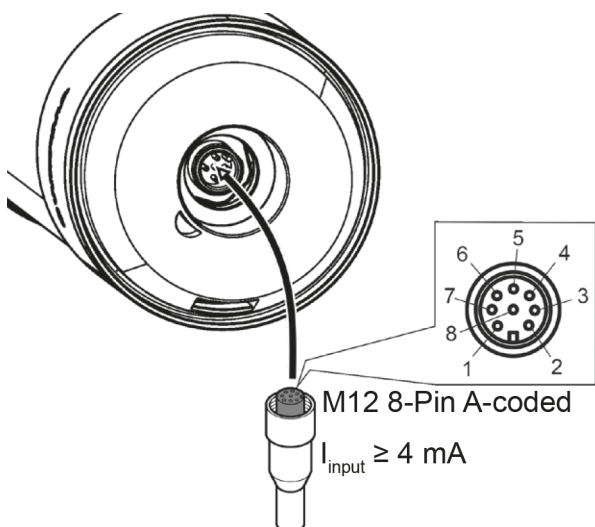

M12 pin assignment	Wire colour of M12 cable	Function
1	White	Signal 1
2	Brown	Signal 2
3	Green	Signal 3
4	Yellow	Signal 4
5	Grey	Signal 5
6	Pink	Signal 6
7	Blue	COM
8	Red	+24V

1.3 System requirements for the eSIGN configuration software

Operating system	Windows 10 x86/x64 Up-to-date Windows updates are a compulsory requirement.
USB port	Required for the hardware configuration.

 Supported operating systems are only supported for as long as Microsoft also supports them through the Microsoft Support Lifecycle.

2 Installing the eSIGN configuration software

The eSIGN configuration software does not need to be installed and runs as a portable version.

1. Download the eSIGN configuration software from the following website: www.werma.com/software.

3 Starting the eSIGN configuration software

1. Double-click on `Werma-eSIGN-Konfigurator.exe`.
→ The eSIGN configuration software starts.

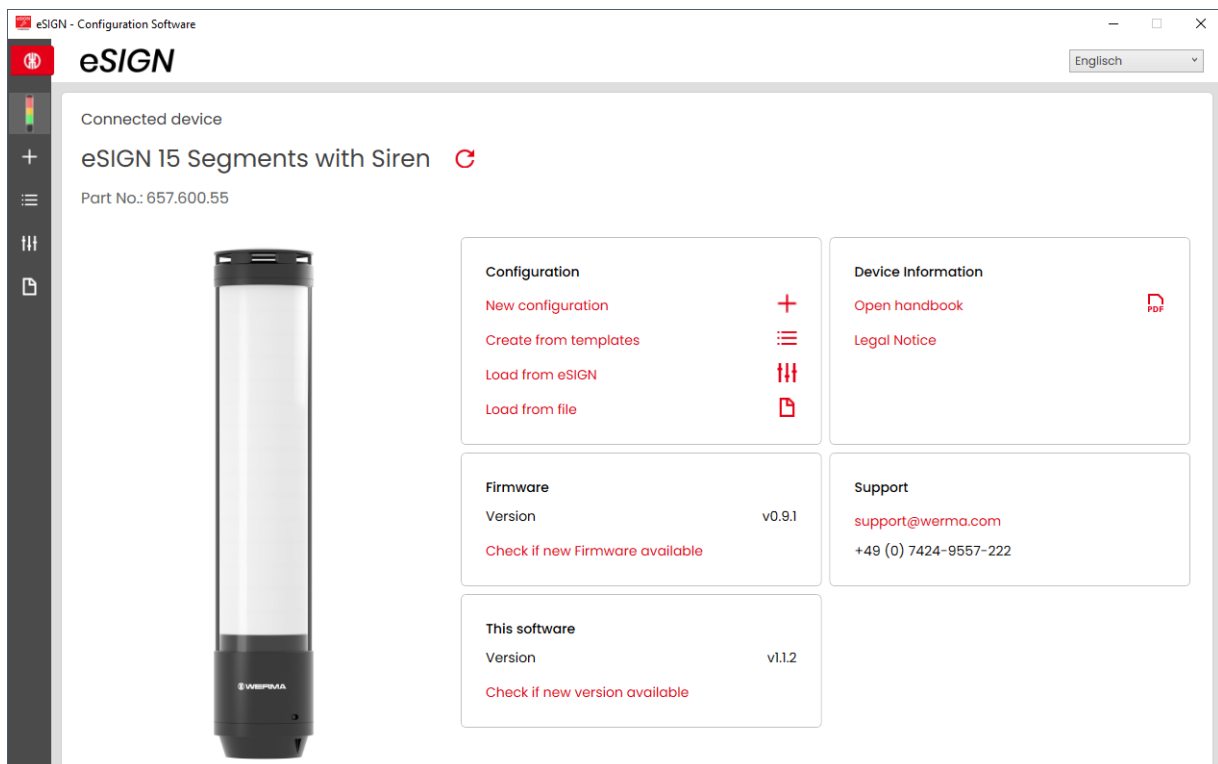

3.1 Overview

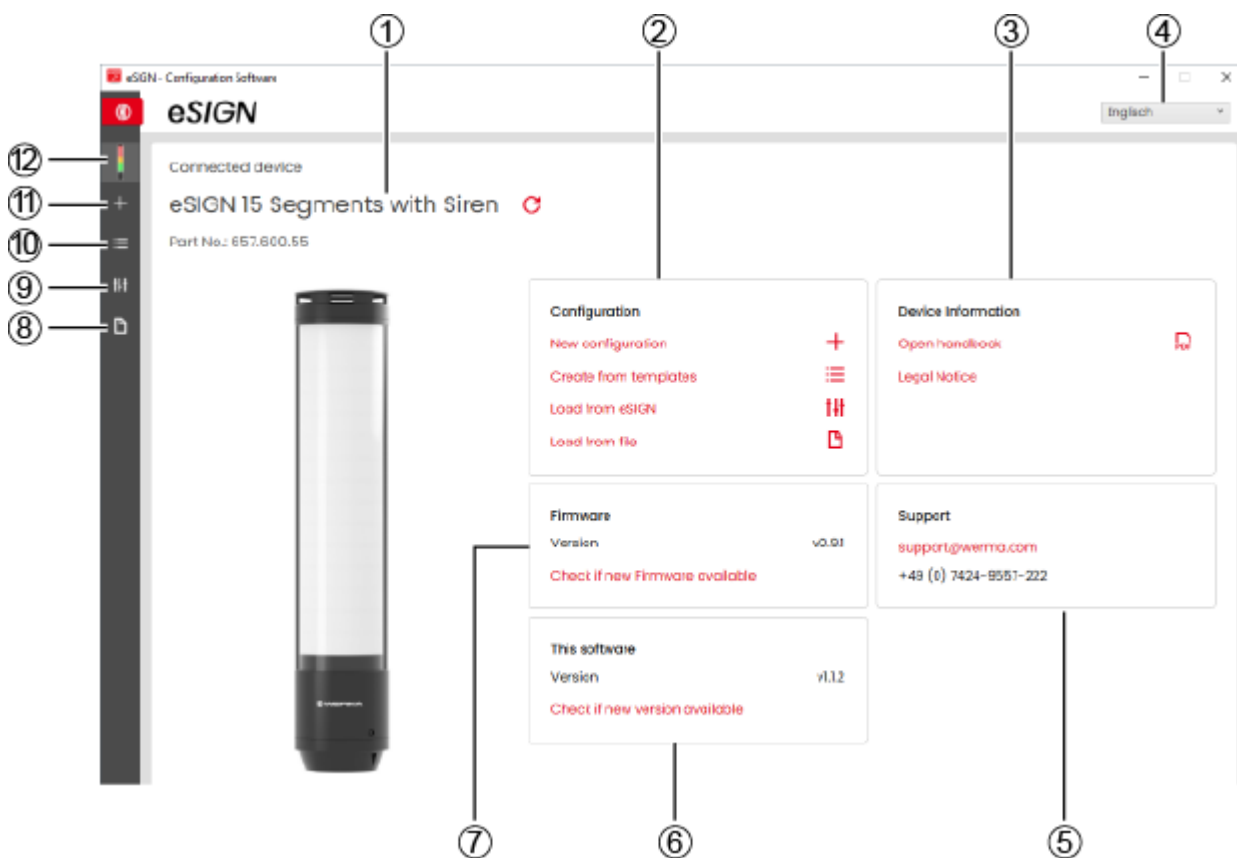

Item	Description
1	Connected eSIGN variant
2	Configuration Area
3	Device Information Area
4	Set the language
5	Support Area
6	This Software Area
7	Firmware Area
8	Open the existing configuration
9	Load the configuration from the eSIGN
10	Create a configuration from sample templates
11	Create a new configuration
12	Open the start screen

3.1.1 Configuration Area

The following options for creating a configuration are available in the **Configuration** area:

- **New configuration:** Create a new configuration (see "Creating a new configuration", p. 115).
- **Create from templates:** Open standard templates that can be transferred to the device immediately (see "Creating a configuration from sample templates", p. 164).
- **Load from eSIGN:** Open the current configuration (for example the default setting) for editing (see "Loading the configuration of the connected eSIGN", p. 166).
- **Load from file:** Open and reuse an existing configuration (see "Opening the existing configuration", p. 167).

3.1.2 Device Information Area

The handbook and legal information can be opened in the **Device Information** area.

3.1.3 Support Area

The **Support** area displays the contact information of the WERMA support team.

3.1.4 This Software Area

The **This Software** area displays information about the eSIGN configuration software and offers a possibility to update the configuration software.

3.1.5 Firmware Area

The **Firmware** area displays information about the firmware of the connected eSIGN and offers a possibility to update the firmware.

3.2 Setting the language

1. Select the desired language in the selection menu.

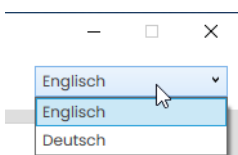

4 Creating a new configuration

EN

 The configuration can be performed with or without connecting an eSIGN.

 The eSIGN can be connected simultaneously to a computer via the USB cable and to the 24V power supply via the M12 cable.

1. Use the USB cable to connect the eSIGN to the computer.
→ The eSIGN configuration software detects the connected eSIGN.

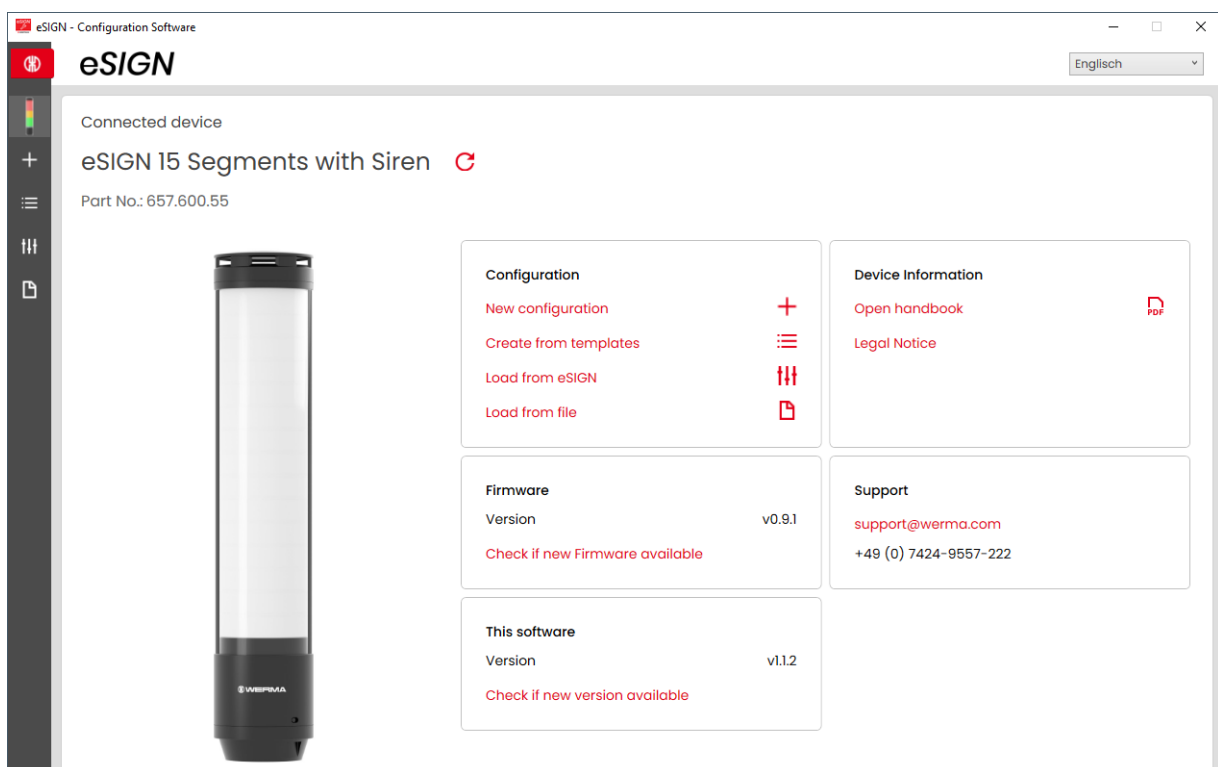

2. If the eSIGN configuration software does not detect the connected eSIGN: Click on **Refresh connected device**.

No Device connected 

3. Click on **New configuration** in the **Configuration** area.

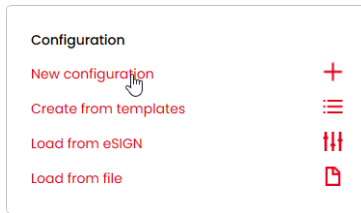

→ The **Create a new configuration** screen appears.

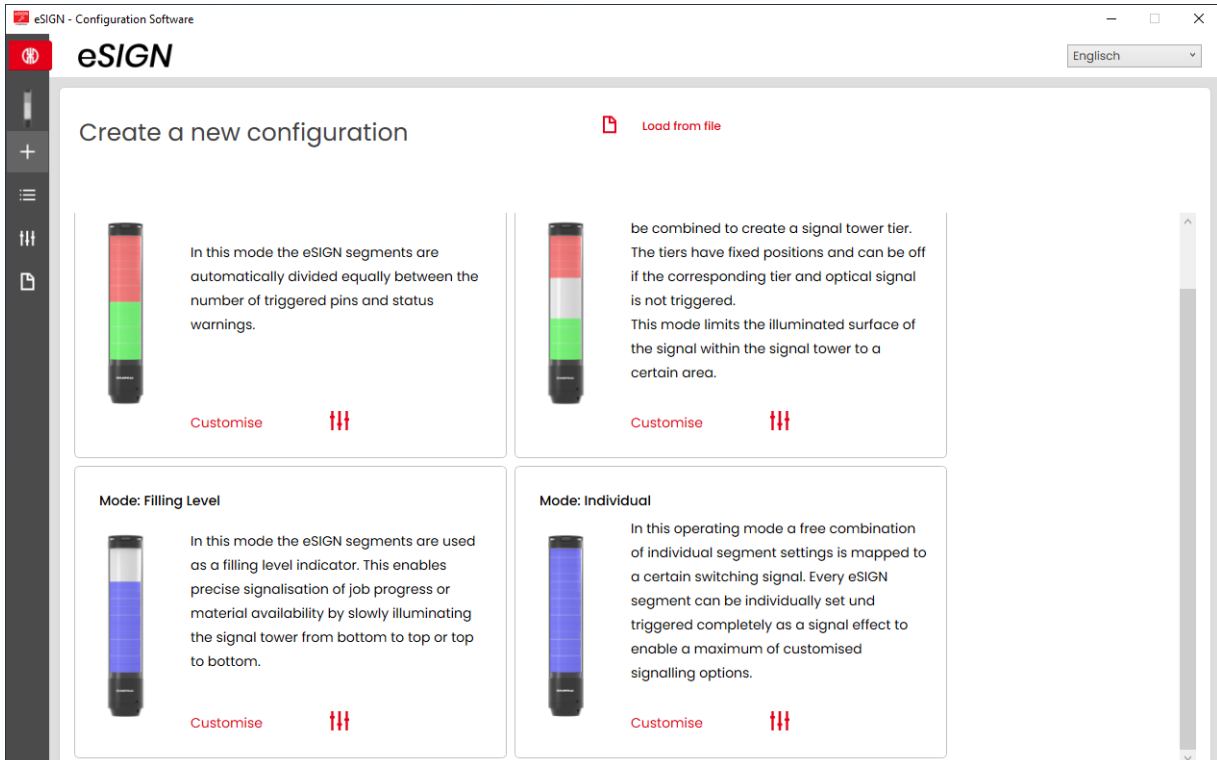

4. Depending on the desired configuration mode, click on **Customise** in the **Autoscale, Signal Tower, Filling Level** or **Individual** area.

Customise

4.1 Autoscale mode

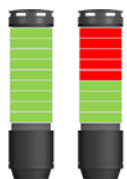

eSIGN segments are automatically divided equally between the number of triggered pins and status warnings.

This enables the full potential of the eSIGN to be exploited by providing full-surface illumination. If for example only one status warning is active then the entire surface of the eSIGN is illuminated in one colour for maximum visibility.

If several status warnings are active, the illuminated area is split proportionally. If the segments cannot be divided equally then the highest priority colour (highest position in the signal tower) receives the remaining segment. If several segments are remaining then they will be divided equally according to the prioritisation (position in the signal tower from top to bottom).

Pos.	Colour	Light Effect	Brightness	Siren	Pin
3	Red	Continuous	[Slider]	No tone	Pin 3: Input 3
2	Orange	Continuous	[Slider]	No tone	Pin 2: Input 2
1	Green	Continuous	[Slider]	No tone	Pin 1: Input 1



If necessary, the orientation of the displayed signal tower can be rotated by 180° with the **Switch mounting position** button.

-
- i** If necessary (for example, to take into account the power limits of control outputs), the power consumption of the eSIGN can be reduced with the **Power Limitation** button. In this case, the current power requirement of the tower is reduced to less than 500 mA. As a result, the optical signals' brightness or the audible signals' volume is reduced.
-

The **Autoscale** mode is the standard default operating mode at the time of delivery and is set as follows:

- Variants with 9 segments:
 - 3 tiers red/yellow/green
 - Continuous light
- Variants with 15 segments:
 - 5 tiers red/yellow/green/white/blue
 - Continuous light

The default setting deviates from this standard for customer-specific versions and is documented separately.

4.1.1 Selecting the eSIGN variant

The variant is pre-selected accordingly if eSIGN has been connected. If no eSIGN has been connected, the variant of the eSIGN to be configured can be selected.

1. If necessary, select the variant of the eSIGN to be configured.

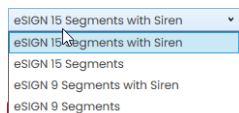

4.1.2 Adding or removing a tier

As soon as a tier is added or removed in **Autoscale** mode, the individual eSIGN segments are automatically re-divided and evenly distributed across all tiers. If the segments cannot be divided equally then the highest priority colour (highest position in the signal tower) receives the remaining segment. If several segments are remaining then they will be divided equally according to the prioritisation (position in the signal tower from top to bottom).

Adding a tier

1. Click on **Add**.



×

→ A tier has been added.

Removing a tier

1. Click on **Remove**.



→ A tier has been removed.

4.1.3 Moving a tier

The individual tiers can be moved up or down as required.

1. In the **Pos.** column, click on the Move up or Move down arrow to move the tier up or down.

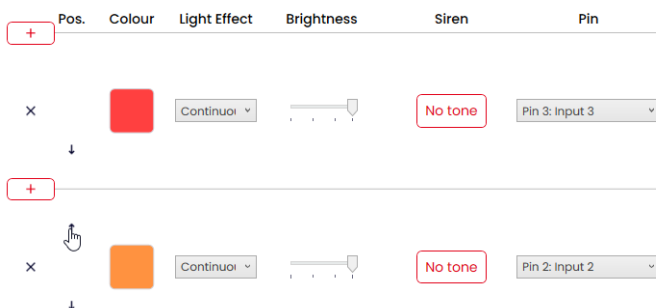

4.1.4 Selecting a colour

A standard colour or individual colour can be assigned to every tier.

1. Click on the colour field in the **Colour** column.



→ The **Select colour** window appears.

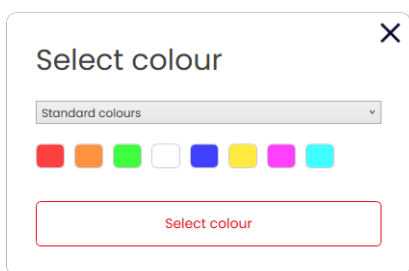

2. Select whether to use a standard colour or an individual colour.

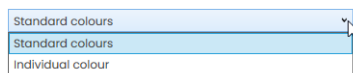

Standard colour

3. Click on the desired colour field.



The following 8 standard colours are available for selection:

- red
- yellow
- green
- white
- blue
- light yellow
- violet
- turquoise

Individual colour

- Select the desired colour in the colour field or enter the appropriate RGB value in the **Red**, **Green** and **Blue** fields.

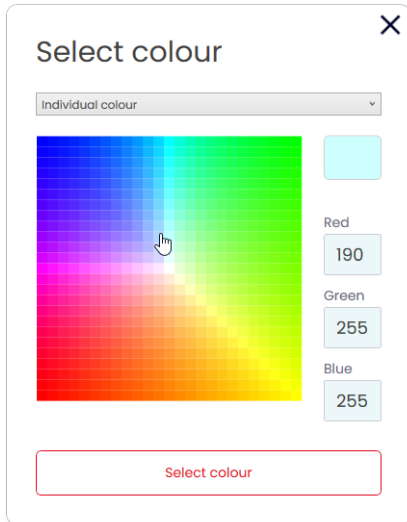

- Click on **Select colour**.

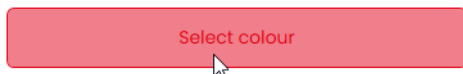

4.1.5 Selecting a light effect

- Select the desired light effect in the **Light Effect** column.

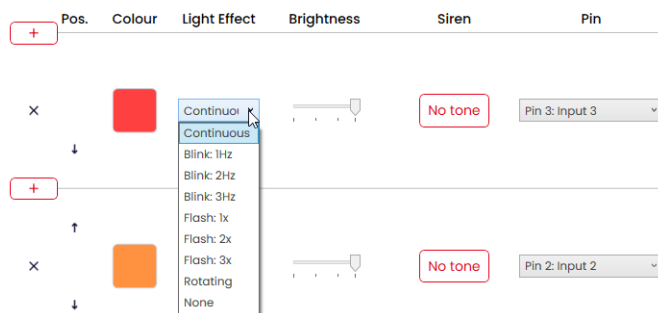

The following 8 light effects are available for selection:

- Continuous light
- Blinking 1 Hz
- Blinking 2 Hz
- Blinking 3 Hz
- Flashing 1x
- Flashing 2x

- Flashing 3x
- Rotating
- None

 The **None** setting can be selected if the tier is only to be configured with a siren.

4.1.6 Setting the brightness

1. Set the desired brightness of the tier from the four options in the **Brightness** column.

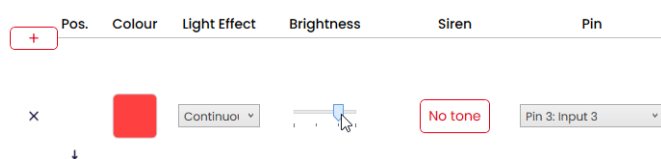

4.1.7 Selecting the siren

If the connected or selected eSIGN has a siren, you can select a signal tone which will sound when the tier is activated.

 If several tiers are set, and the tiers are activated at the same time, the siren will sound for the colour with the highest priority (highest position within the tower).

1. Click on **No tone** in the **Siren** column.





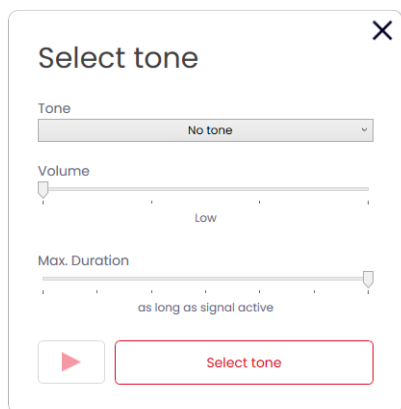



→ The **Select tone** window appears.

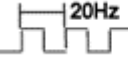
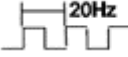
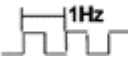

2. Select the desired **Tone**, the desired **Volume** and **Max. Duration**.

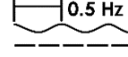
The following 10 tones are available for selection:

Sound	Frequency	Description	Max. dB (A)
1	 2.7 kHz	Continuous tone	104
2	 0.9 kHz	Continuous tone	96
3	 2.8 kHz	Pulse tone	97
4	 0.9 kHz	Pulse tone	93
5	 2.8 kHz	Pulse tone	103
6	 0.9 kHz	Pulse tone	96
7	 2.8 kHz	Pulse tone	104
8	 2.3 kHz- 3.6 kHz	Sweep tone	104
9	 2.6 kHz	Continuous tone	105
10	 1200 Hz 800 Hz	Alternating tone	92



The selected settings can be tested using the **Play** button (▶). The sound file is then played by the computer.

3. Click on **Select tone**.

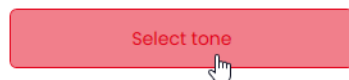

4.1.8 Selecting a pin



The fields are pre-configured with a standard configuration, starting from the bottom tier of the tower with pin 1.

Pins that are already in use are shown in grey. The configuration can be changed as required.

1. In the **Pin** column select the pin of the 8-pin connector on which the signal to trigger the tier is sent.

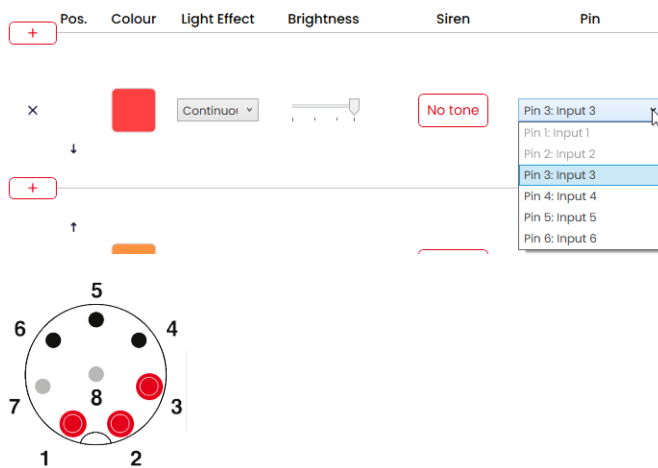

Modifying the pin configuration

If necessary, the assignment of the wire colour to the pin can be changed and a description of the signal added.

1. Click on **PIN Configuration** under the pin overview.

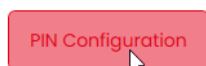

→ The **PIN Configuration** window appears.

PIN Configuration ✕

	Wire Colour	Description
Pin 1: Input 1	<input type="text" value="WH"/>	<input type="text"/>
Pin 2: Input 2	<input type="text" value="BN"/>	<input type="text"/>
Pin 3: Input 3	<input type="text" value="GN"/>	<input type="text"/>
Pin 4: Input 4	<input type="text" value="YE"/>	<input type="text"/>
Pin 5: Input 5	<input type="text" value="GY"/>	<input type="text"/>
Pin 6: Input 6	<input type="text" value="PK"/>	<input type="text"/>
Pin 7: COM	<input type="text" value="BU"/>	<input type="text"/>
Pin 8: +24V	<input type="text" value="RD"/>	<input type="text"/>

2. Enter the desired wire colour in the **Wire Colour** column.
3. Enter the description of the signal in the **Description** column.
4. Click on **Save**.

4.1.9 Simulating signal inputs

Once all settings have been made, the signal inputs can be simulated.

1. Click on the pin that activates the desired tier in the pin overview.

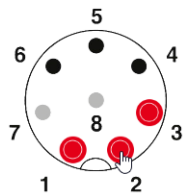

4.1.10 Finalising the configuration

1. Make additional changes to the configuration as required.
2. Once all tiers are configured as desired, click on **Finalise**.
→ The **Finalise** window appears.



3. Click on **Save** to save the configuration in a configuration file.
4. Click on **Send to device** to transfer the configuration to the connected eSIGN.
5. Click on **Open PDF Configuration Sheet** to display an overview of the current configuration.
6. Click on **Save PDF Configuration Sheet** to save the overview of the current configuration as a PDF file.

4.2 Signal tower mode

EN

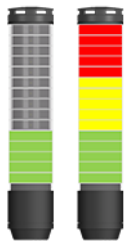

Individual eSIGN segments can be combined to create a signal tower tier. This enables a classic signal tower to be created in an electronically modular form. In this mode the tiers have fixed positions and can be off if the corresponding tier and optical signal is not triggered.

This mode limits the illuminated surface of the signal within the signal tower to a certain area.

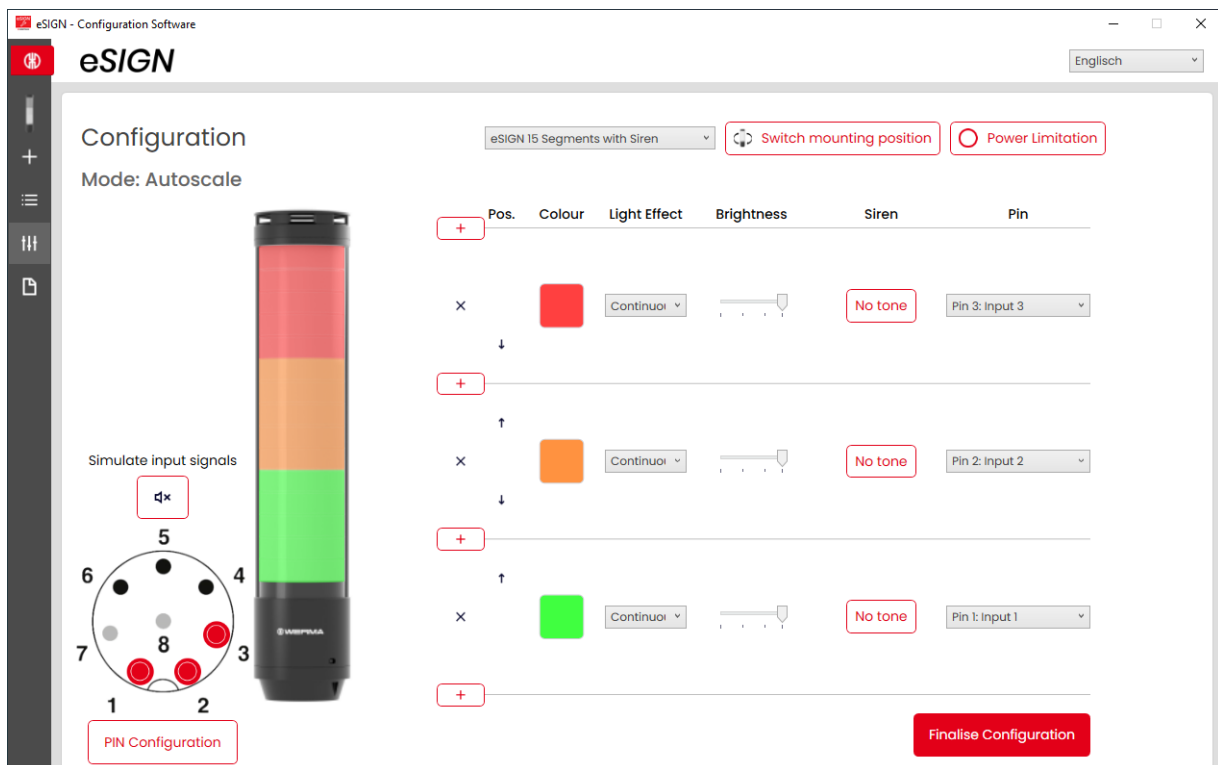

i If necessary, the orientation of the displayed signal tower can be rotated by 180° with the **Switch mounting position** button.

i If necessary (for example, to take into account the power limits of control outputs), the power consumption of the eSIGN can be reduced with the **Power Limitation** button. In this case, the current power requirement of the tower is reduced to less than 500 mA. As a result, the optical signals' brightness or the audible signals' volume is reduced.

4.2.1 Selecting the eSIGN variant

The variant is pre-selected accordingly if eSIGN has been connected. If no eSIGN has been connected, the variant of the eSIGN to be configured can be selected.

1. If necessary, select the variant of the eSIGN to be configured.

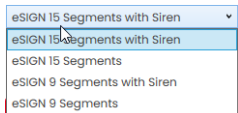

4.2.2 Adding or removing a tier

As soon as a tier is added or removed in **Signal Tower** mode, the individual eSIGN segments are automatically re-divided and evenly distributed across all tiers.

Adding a tier

1. Click on **Add**.



×

→ A tier has been added.

Removing a tier

1. Click on **Remove**.



→ A tier has been removed.

4.2.3 Moving a tier

The individual tiers can be moved up or down as required.

1. In the **Pos.** column, click on the Move up or Move down arrow to move the tier up or down.

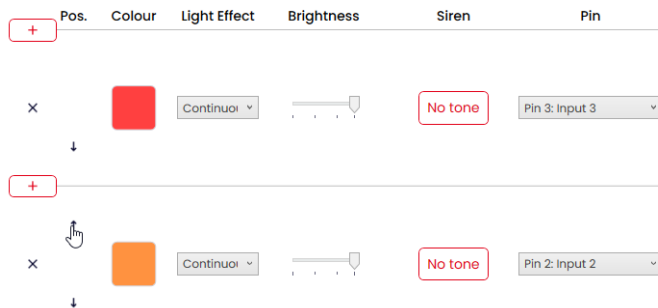

4.2.4 Selecting a colour

A standard colour or individual colour can be assigned to every tier.

1. Click on the colour field in the **Colour** column.



→ The **Select colour** window appears.

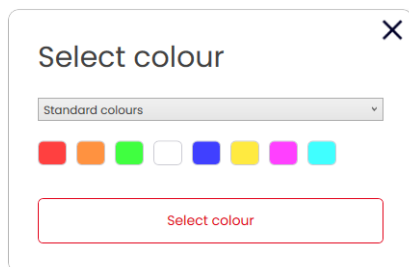

2. Select whether to use a standard colour or an individual colour.

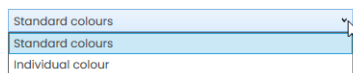

Standard colour

3. Click on the desired colour field.



The following 8 standard colours are available for selection:

- red
- yellow
- green
- white
- blue
- light yellow
- violet
- turquoise

Individual colour

4. Select the desired colour in the colour field or enter the appropriate RGB value in the **Red**, **Green** and **Blue** fields.

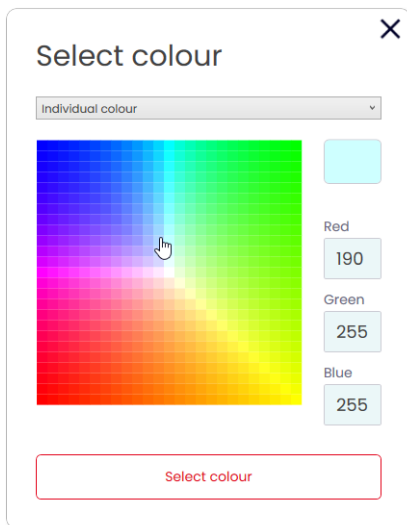

5. Click on **Select colour**.

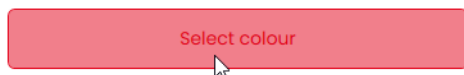

4.2.7 Selecting the siren

If the connected or selected eSIGN has a siren, you can select a signal tone which will sound when the tier is activated.



If several tiers are set, and the tiers are activated at the same time, the siren will sound for the colour with the highest priority (highest position within the tower).

1. Click on **No tone** in the **Siren** column.





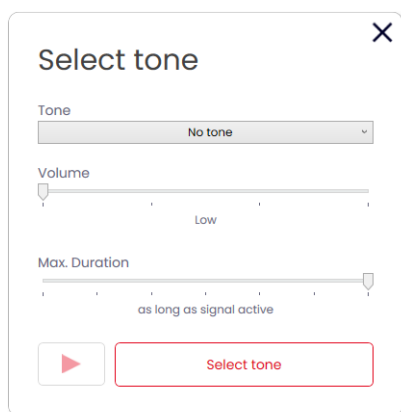



→ The **Select tone** window appears.

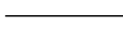
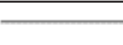

2. Select the desired **Tone**, the desired **Volume** and **Max. Duration**.

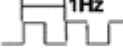
The following 10 tones are available for selection:

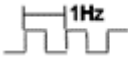
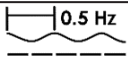
Sound	Frequency	Description	Max. dB (A)
1	 2.7 kHz	Continuous tone	104
2	 0.9 kHz	Continuous tone	96
3	 2.8 kHz	Pulse tone	97
4	 0.9 kHz	Pulse tone	93
5	 2.8 kHz	Pulse tone	103
6	 0.9 kHz	Pulse tone	96

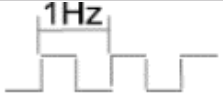
Sound	Frequency	Description	Max. dB (A)
7	 2.8 kHz	Pulse tone	104
8	 2.3 kHz- 3.6 kHz	Sweep tone	104
9	 2.6 kHz	Continuous tone	105
10	 1200 Hz 800 Hz	Alternating tone	92

 The selected settings can be tested using the **Play** button (▶). The sound file is then played by the computer.

3. Click on **Select tone**.

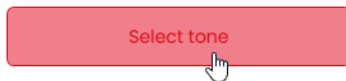

4.2.8 Selecting a pin

i The fields are pre-configured with a standard configuration, starting from the bottom tier of the tower with pin 1.

Pins that are already in use are shown in grey. The configuration can be changed as required.

1. In the **Pin** column select the pin of the 8-pin connector on which the signal to trigger the tier is sent.

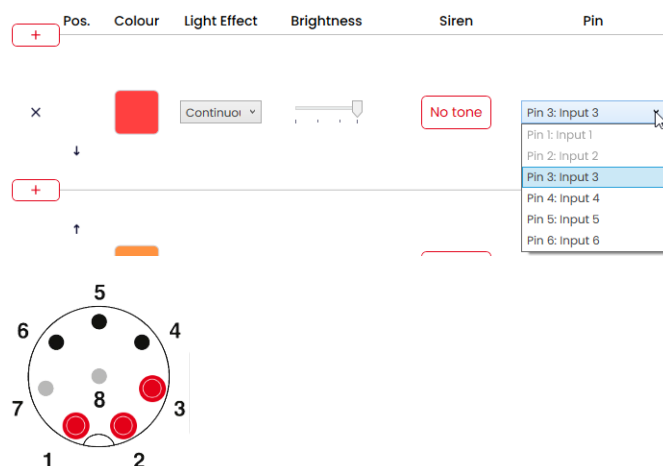

Modifying the pin configuration

If necessary, the assignment of the wire colour to the pin can be changed and a description of the signal added.

1. Click on **PIN Configuration** under the pin overview.

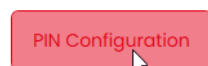

→ The **PIN Configuration** window appears.

PIN Configuration ✕

	Wire Colour	Description
Pin 1: Input 1	<input type="text" value="WH"/>	<input type="text"/>
Pin 2: Input 2	<input type="text" value="BN"/>	<input type="text"/>
Pin 3: Input 3	<input type="text" value="GN"/>	<input type="text"/>
Pin 4: Input 4	<input type="text" value="YE"/>	<input type="text"/>
Pin 5: Input 5	<input type="text" value="GY"/>	<input type="text"/>
Pin 6: Input 6	<input type="text" value="PK"/>	<input type="text"/>
Pin 7: COM	<input type="text" value="BU"/>	<input type="text"/>
Pin 8: +24V	<input type="text" value="RD"/>	<input type="text"/>

2. Enter the desired wire colour in the **Wire Colour** column.
3. Enter the description of the signal in the **Description** column.
4. Click on **Save**.

4.2.9 Simulating signal inputs

Once all settings have been made, the signal inputs can be simulated.

1. Click on the pin that activates the desired tier in the pin overview.

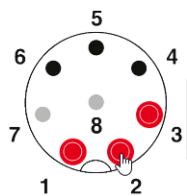

4.2.10 Finalising the configuration

1. Make additional changes to the configuration as required.
2. Once all tiers are configured as desired, click on **Finalise**.
→ The **Finalise** window appears.



3. Click on **Save** to save the configuration in a configuration file.
4. Click on **Send to device** to transfer the configuration to the connected eSIGN.
5. Click on **Open PDF Configuration Sheet** to display an overview of the current configuration.
6. Click on **Save PDF Configuration Sheet** to save the overview of the current configuration as a PDF file.

4.3 Filling Level mode

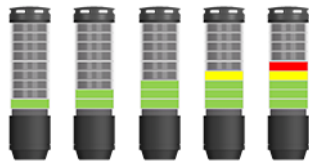

In this operating mode eSIGN segments are used as a filling level indicator. This enables precise signalisation of job progress or material availability in machine processes by slowly illuminating the signal tower from bottom to top or top to bottom.

Mode: Filling Level
✕

Device

eSIGN 15 Segments with Siren

Colours

Single Colour

Number of signal combinations: 15

= Number of assigned segments: 15

= Number of unassigned segments: 0

Allocation of unassigned segments

Top (filled)

Generate Configuration

4.3.1 Selecting the eSIGN variant

The variant is pre-selected accordingly if eSIGN has been connected. If no eSIGN has been connected, the variant of the eSIGN to be configured can be selected.

1. If necessary, select the variant of the eSIGN in **Device** field.

Device

eSIGN 15 Segments with Siren

eSIGN 15 Segments with Siren

eSIGN 15 Segments

eSIGN 9 Segments with Siren

eSIGN 9 Segments

4.3.2 Selecting the number of signal combinations

1. Select in the **Number of signal combinations** area how many eSIGN segments are to be used for the filling level indicator.

If not all eSIGN segments are used for the filling level indicator:

2. Select in the **Allocation of unassigned segments** field how to display the eSIGN segments that are not to be used for the filling level indicator.

Setting	Description
Top (filled)	Unassigned eSIGN segments are assigned to the top and triggered with the top tier.
Bottom (filled)	Unassigned eSIGN segments are assigned to the bottom and triggered with the bottom tier.
Top (not active)	Unassigned eSIGN segments are assigned to the top and are always off.
Bottom (not active)	Unassigned eSIGN segments are assigned to the bottom and are always off.

4.3.3 Selecting a colour

A uniform colour or colour gradient can be selected for the filling level indicator. The colour gradient option means that the gradual transformation between the two colours is automatically calculated.

If necessary, the colour of each segment of the filling level indicator can be adjusted later.

1. In the **Colours** field, select whether the fill level should be displayed in a uniform colour or as a colour gradient.

Single colour

2. Click on the colour field to select the desired colour.
→ The **Select colour** window appears.

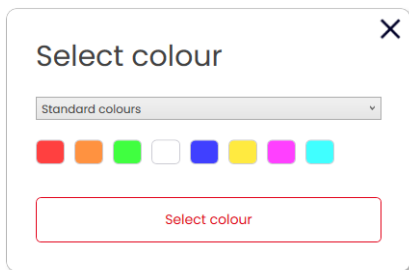

3. Select whether to use a standard colour or an individual colour.

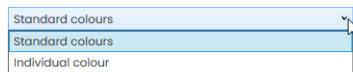

Standard colour

4. Click on the desired colour field.



The following 8 standard colours are available for selection:

- red
- yellow
- green
- white
- blue
- light yellow
- violet
- turquoise

Individual colour

5. Select the desired colour in the colour field or enter the appropriate RGB value in the **Red**, **Green** and **Blue** fields.

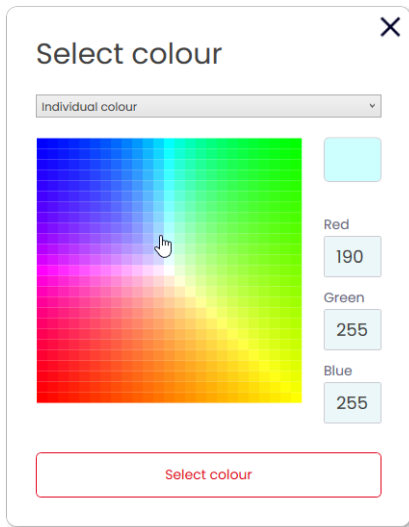

6. Click on **Select colour**.

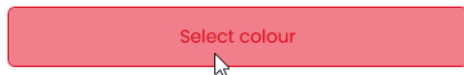

7. Click on **Generate configuration**.
→ The **Configuration** screen appears.

Colour gradient

8. Click on the colour fields for the start and end colour of the colour gradient.
→ The **Select colour** window appears.

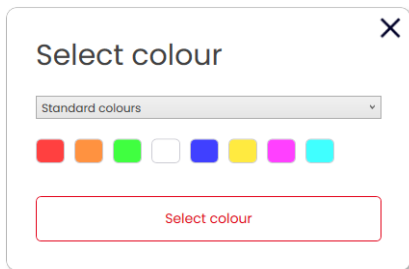

9. Select whether to use a standard colour or an individual colour.

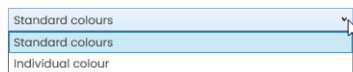

Standard colour

10. Click on the desired colour field.



Individual colour

11. Select the desired colour in the colour field or enter the appropriate RGB value in the **Red**, **Green** and **Blue** fields.

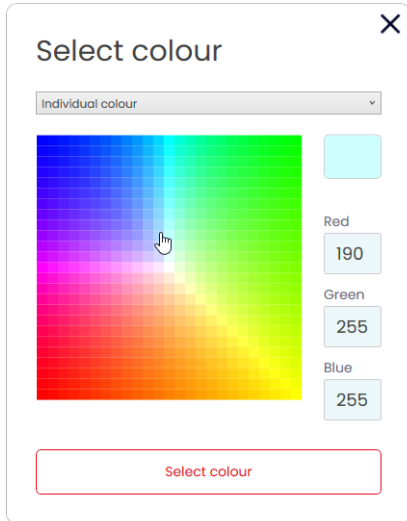

12. Click on **Select colour**.

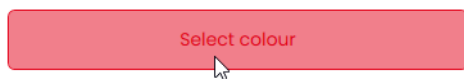

13. Click on **Generate configuration**.
→ The **Configuration** screen appears.

Removing or adding segments

Removing a segment

1. Click on **Remove**.

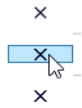

→ The segment has been removed.

Adding a segment

1. Click on **Add**.

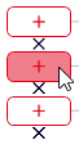





→ The segment has been added.

Moving a segment

The individual segments can be moved up or down as required.

1. In the **Pos.** column, click on the Move up or Move down arrow to move the segment up or down.

	Pos.	Colour	Light Effect	Brightness	Siren	Pin				
x	↓		Continui		No tone	6	<input type="checkbox"/>	<input checked="" type="checkbox"/>	<input checked="" type="checkbox"/>	1
x	↑		Continui		No tone	6	<input type="checkbox"/>	<input checked="" type="checkbox"/>	<input checked="" type="checkbox"/>	1

Selecting a colour

A standard colour can be selected for each segment or an individual colour assigned as required.

1. Click on the colour field in the **Colour** column.

	Pos.	Colour	Light Effect	Brightness	Siren	Pin				
x	↓		Continual		No tone	6	<input type="checkbox"/>	<input checked="" type="checkbox"/>	<input checked="" type="checkbox"/>	<input checked="" type="checkbox"/>
x	↑		Continual		No tone	6	<input type="checkbox"/>	<input checked="" type="checkbox"/>	<input checked="" type="checkbox"/>	<input type="checkbox"/>

→ The **Select colour** window appears.

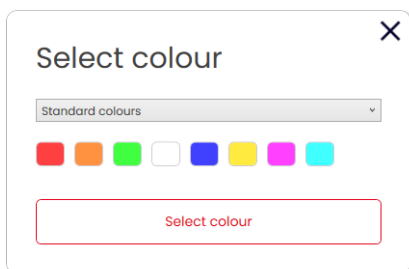

2. Select whether to use a standard colour or an individual colour.

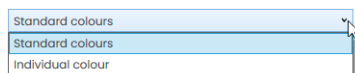

Standard colour

3. Click on the desired colour field.



The following 8 standard colours are available for selection:

- red
- yellow
- green
- white
- blue
- light yellow
- violet
- turquoise

Individual colour

4. Select the desired colour in the colour field or enter the appropriate RGB value in the **Red**, **Green** and **Blue** fields.

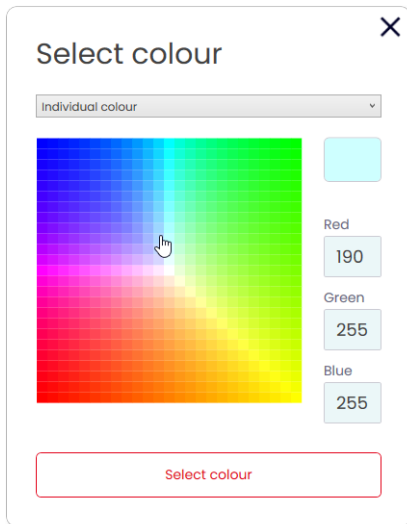

5. Click on **Select colour**.

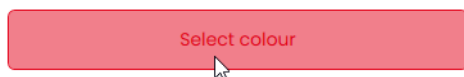

Selecting a light effect

1. Select the desired light effect in the **Light Effect** column.

Pos.	Colour	Light Effect	Brightness	Siren	Pin
x	↓	Continuous	<input type="text"/>	No tone	6 <input type="checkbox"/> 1 <input checked="" type="checkbox"/>
x	↑	Continuous	<input type="text"/>	No tone	6 <input type="checkbox"/> 1 <input checked="" type="checkbox"/>
x	↓	Blink: 1Hz	<input type="text"/>	No tone	6 <input type="checkbox"/> 1 <input checked="" type="checkbox"/>
x	↑	Blink: 2Hz	<input type="text"/>	No tone	6 <input type="checkbox"/> 1 <input checked="" type="checkbox"/>
x	↓	Blink: 3Hz	<input type="text"/>	No tone	6 <input type="checkbox"/> 1 <input checked="" type="checkbox"/>
x	↑	Flash: 1x	<input type="text"/>	No tone	6 <input type="checkbox"/> 1 <input checked="" type="checkbox"/>
x	↓	Flash: 2x	<input type="text"/>	No tone	6 <input type="checkbox"/> 1 <input checked="" type="checkbox"/>
x	↑	Flash: 3x	<input type="text"/>	No tone	6 <input type="checkbox"/> 1 <input checked="" type="checkbox"/>
x	↓	Rotating	<input type="text"/>	No tone	6 <input type="checkbox"/> 1 <input checked="" type="checkbox"/>
x	↑	None	<input type="text"/>	No tone	6 <input type="checkbox"/> 1 <input checked="" type="checkbox"/>

The following 8 light effects are available for selection:

- Continuous light
- Blinking 1 Hz
- Blinking 2 Hz
- Blinking 3 Hz
- Flashing 1x
- Flashing 2x
- Flashing 3x
- Rotating
- None



The **None** setting can be selected if the tier is only to be configured with a siren.

Setting the brightness

1. Set the desired brightness of the tier from the four options in the **Brightness** column.

	Pos.	Colour	Light Effect	Brightness	Siren	Pin	
x	↓	■	Continuoi		No tone	6	1
x	↓	■	Continuoi		No tone	6	1

Selecting the siren

If the connected or selected eSIGN has a siren, you can select a signal tone which will sound when the segment is activated.

i If several tiers are set, and the tiers are activated at the same time, the siren will sound for the colour with the highest priority (highest position within the tower).

1. Click on **No tone** in the **Siren** column.

	Pos.	Colour	Light Effect	Brightness	Siren	Pin	
x	↓	■	Continuoi		No tone	6	1
x	↓	■	Continuoi		No tone	6	1

→ The **Select tone** window appears.

Select tone
✕

Tone

No tone

Volume

Low

Max. Duration

as long as signal active





▶

Select tone

2. Select the desired **Tone**, the desired **Volume** and **Max. Duration**.

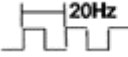
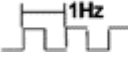
The following 10 tones are available for selection:

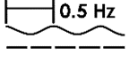
Sound	Frequency	Description	Max. dB (A)
1	2.7 kHz	Continuous tone	104
2	0.9 kHz	Continuous tone	96
3	420Hz 2.8 kHz	Pulse tone	97
4	20Hz 0.9 kHz	Pulse tone	93

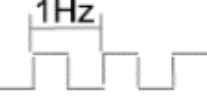
Sound	Frequency	Description	Max. dB (A)
5	 2.8 kHz	Pulse tone	103
6	 0.9 kHz	Pulse tone	96
7	 2.8 kHz	Pulse tone	104
8	 2.3 kHz- 3.6 kHz	Sweep tone	104
9	 2.6 kHz	Continuous tone	105
10	 1200 Hz 800 Hz	Alternating tone	92

 The selected settings can be tested using the **Play** button (▶). The sound file is then played by the computer.

3. Click on **Select tone**.

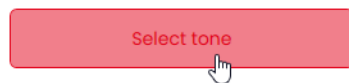

Selecting a pin

i The fields are pre-configured with a standard configuration, starting from the bottom tier of the tower with pin 1.

Pins that are already in use are shown in grey. The configuration can be changed as required.

The filling level indicator is triggered via bit coding. The checkboxes in the **Pin** column correspond to the 6 pins or signal inputs. Selecting one or more checkboxes indicates that these pins or signal inputs must be triggered to activate the corresponding setting.

Example:

For the complete tower to be displayed in green, pins 1-4 must be triggered.

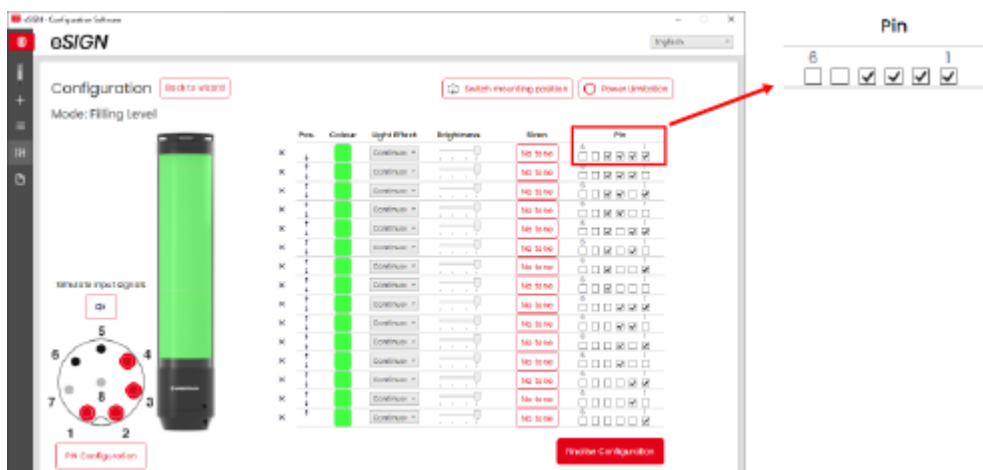

1. In the **Pin** column select the pins of the 8-pin connector on which the signal to trigger the tier is sent.

Pos.	Colour	Light Effect	Brightness	Siren	Pin
X	Green	Continual	[Slider]	No tone	6 <input type="checkbox"/> <input checked="" type="checkbox"/> <input checked="" type="checkbox"/> <input checked="" type="checkbox"/> <input checked="" type="checkbox"/> <input type="checkbox"/>
X	Green	Continual	[Slider]	No tone	6 <input type="checkbox"/> <input checked="" type="checkbox"/> <input checked="" type="checkbox"/> <input checked="" type="checkbox"/> <input type="checkbox"/> <input type="checkbox"/>

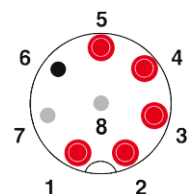

Modifying the pin configuration

If necessary, the assignment of the wire colour to the pin can be changed and a description of the signal added.

1. Click on **PIN Configuration** under the pin overview.



→ The **PIN Configuration** window appears.

PIN Configuration

	Wire Colour	Description
Pin 1: Input 1	WH	
Pin 2: Input 2	BN	
Pin 3: Input 3	GN	
Pin 4: Input 4	YE	
Pin 5: Input 5	GY	
Pin 6: Input 6	PK	
Pin 7: COM	BU	
Pin 8: +24V	RD	

Save

2. Enter the desired wire colour in the **Colour** column.
3. Enter the description of the signal in the **Description** column.
4. Click on **Save**.

4.3.5 Simulating signal inputs

Once all settings have been made, the signal inputs can be simulated.

1. Click on the pin that activates the desired tier in the pin overview.

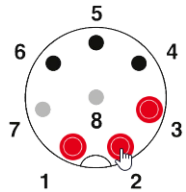

4.3.6 Finalising the configuration

1. Make additional changes to the configuration as required.
2. Once all tiers are configured as desired, click on **Finalise**.
→ The **Finalise** window appears.

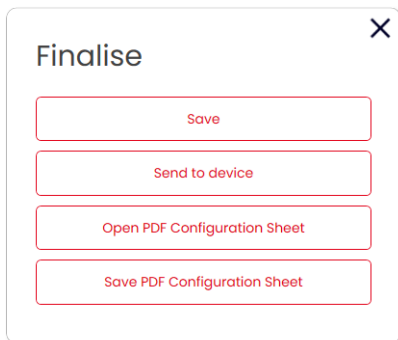

3. Click on **Save** to save the configuration in a configuration file.
4. Click on **Send to device** to transfer the configuration to the connected eSIGN.
5. Click on **Open PDF Configuration Sheet** to display an overview of the current configuration.
6. Click on **Save PDF Configuration Sheet** to save the overview of the current configuration as a PDF file.

4.4 Individual mode



In this operating mode a free combination of individual segment settings is mapped to a certain switching signal. Every eSIGN segment can be individually set and triggered as a complete signal effect in the form of the entire signal tower to enable a maximum of customised signalling options.

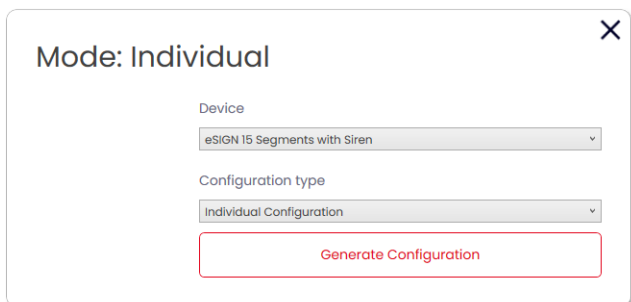

4.4.1 Selecting the eSIGN variant

The variant is pre-selected accordingly if eSIGN has been connected. If no eSIGN has been connected, the variant of the eSIGN to be configured can be selected.

1. If necessary, select the variant of the eSIGN in the **Device** field.

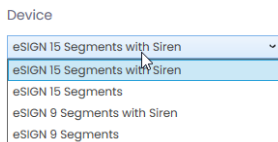

2. Click on **Generate configuration**.
→ The **Configuration** screen appears.

4.4.2 Configuring signal effects

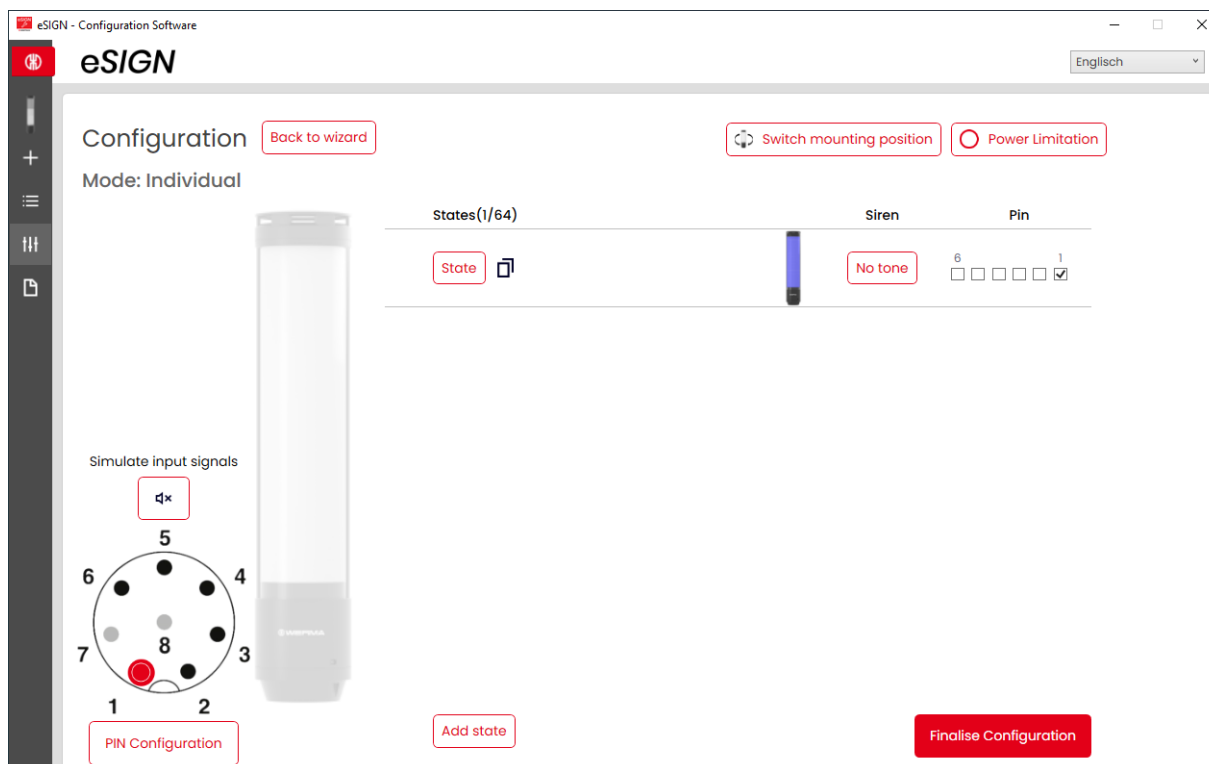

- i** If necessary, the orientation of the displayed signal tower can be rotated by 180° with the **Switch mounting position** button.
- i** If necessary (for example, to take into account the power limits of control outputs), the power consumption of the eSIGN can be reduced with the **Power Limitation** button. In this case, the current power requirement of the tower is reduced to less than 500 mA. As a result, the optical signals' brightness or the audible signals' volume is reduced.
- i** The configuration of the eSIGN variant can be opened and adjusted again via the **Back to wizard** link as required.

Modifying the signal effect



Up to 64 signal effects can be configured and transferred to an eSIGN.

A signal effect consists of the individual optical settings of each segment and, if relevant, a signal tone.

1. Click on **State**.

States(1/64)



→ The **State** window appears.

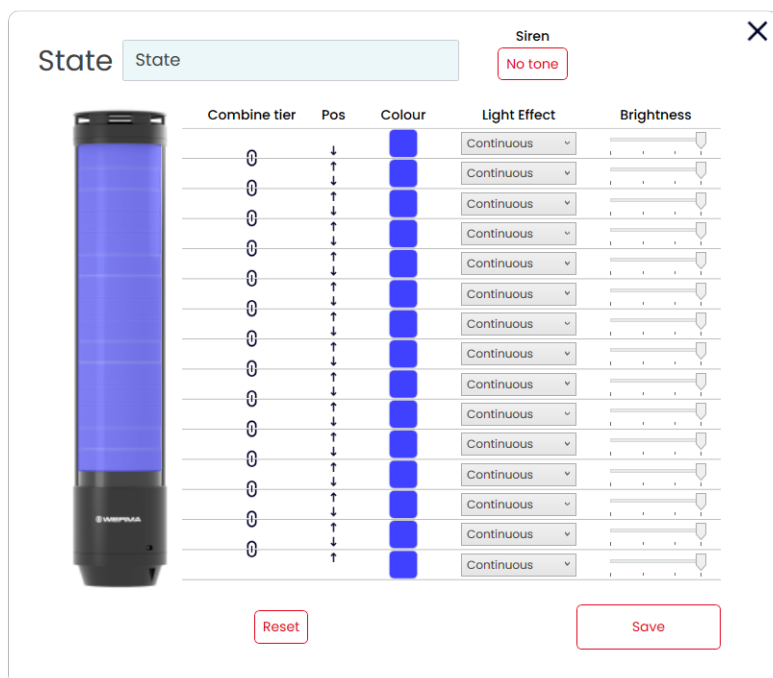

If necessary, the current signal effect can be reset to the default settings via the **Reset** button.

Naming the signal effect

1. Enter a description for the current signal effect in the **State** field.

Selecting the siren

If the connected or selected eSIGN has a siren, you can select a signal tone which will sound when the signal effect is activated.

1. Click on **No tone** in the **Siren** field.

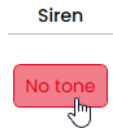

→ The **Select tone** window appears.

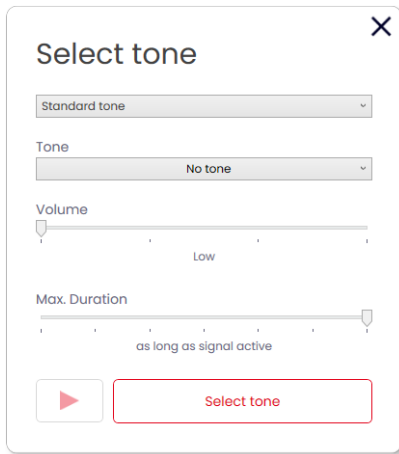



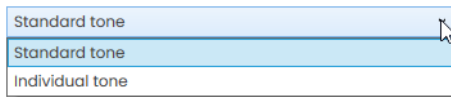



2. Select whether to use a standard tone or an individual tone.

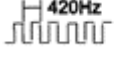
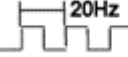
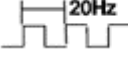

Standard tone

3. Select the desired **Tone**, the desired **Volume** and **Max. Duration**.

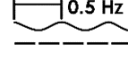
The following 10 tones are available for selection:

Sound	Frequency	Description	Max. dB (A)
1	 2.7 kHz	Continuous tone	104
2	 0.9 kHz	Continuous tone	96
3	 2.8 kHz	Pulse tone	97
4	 0.9 kHz	Pulse tone	93
5	 2.8 kHz	Pulse tone	103
6	 0.9 kHz	Pulse tone	96
7	 2.8 kHz	Pulse tone	104
8	 2.3 kHz- 3.6 kHz	Sweep tone	104
9	 2.6 kHz	Continuous tone	105
10	 1200 Hz 800 Hz	Alternating tone	92

 The selected settings can be tested using the **Play** button (▶). The sound file is then played by the computer.

4. Click on **Select tone**.

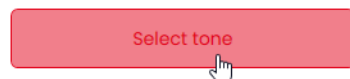

Individual tone

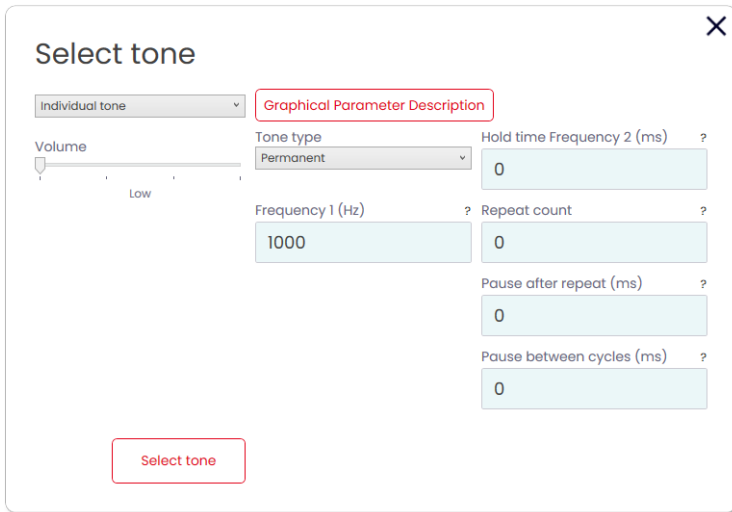

1. Make the settings as desired.

i The **Individual tone** option allows a customer-specific tone to be generated from different parameters.

Further information on the individual settings can be accessed via the **Graphical Parameter Description** button and by clicking on **?**.

The following screen can be accessed via the **Graphical Parameter Description** button to indicate the effect of the individual settings:

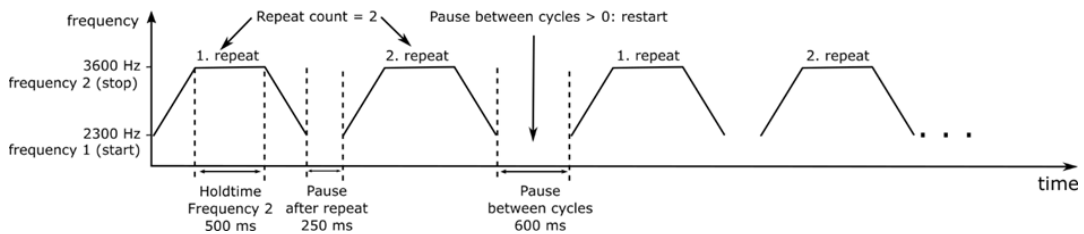

2. Click on **Select tone**.

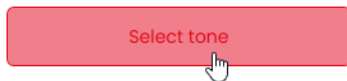

Connecting or separating segments

If required, multiple segments can be connected to form a tier and then separated again.

Connecting segments

1. In the **Combine tier** column, click on the **Combine tier** symbol.

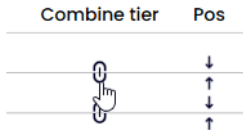

Separating segments

1. In the **Combine tier** column, click on the **Separate tier** symbol.



Moving tiers

The individual tiers can be moved up or down as required.

1. In the **Pos.** column, click on the Move up or Move down arrow to move the tier up or down.

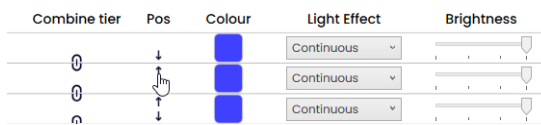

Selecting a colour

A standard colour can be selected for each segment or an individual colour assigned as required.

1. Click on the colour field in the **Colour** column.



→ The **Select colour** window appears.

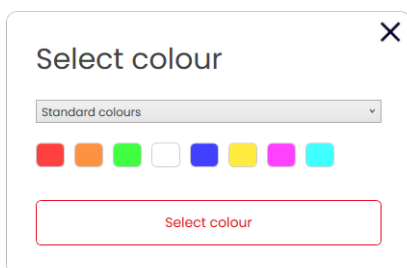

2. Select whether to use a standard colour or an individual colour.

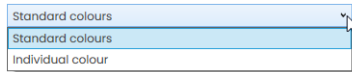

Standard colour

3. Click on the desired colour field.



The following 8 standard colours are available for selection:

- red
- yellow
- green
- white
- blue
- light yellow
- violet
- turquoise

Individual colour

4. Select the desired colour in the colour field or enter the appropriate RGB value in the **Red**, **Green** and **Blue** fields.

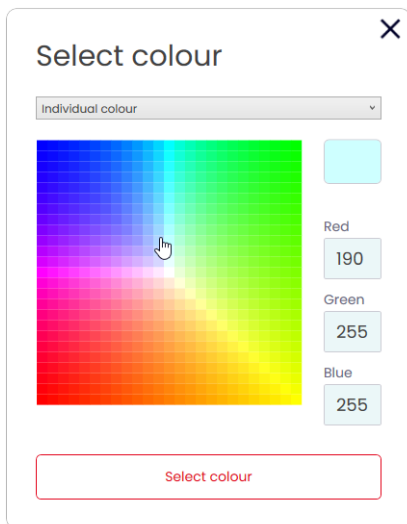

5. Click on **Select colour**.



Selecting a light effect

1. Select the desired light effect in the **Light Effect** column.

Combine tier	Pos	Colour	Light Effect	Brightness
0	↓	■	Continuous	▬
0	↑	■	Continuous	▬
0	↓	■	Blink: 1Hz	▬
0	↑	■	Blink: 2Hz	▬
0	↓	■	Blink: 3Hz	▬
0	↑	■	Flash: 1x	▬
0	↓	■	Flash: 2x	▬
0	↑	■	Flash: 3x	▬
0	↓	■	Rotating	▬
0	↑	■	None	▬
n	↓	■	Continuous	▬

The following 8 light effects are available for selection:

- Continuous light
- Blinking 1 Hz
- Blinking 2 Hz
- Blinking 3 Hz
- Flashing 1x
- Flashing 2x
- Flashing 3x
- Rotating
- None

Setting the brightness

1. Set the desired brightness of the tier from the four options in the **Brightness** column.

Combine tier	Pos	Colour	Light Effect	Brightness
0	↓	■	Continuous	▬
n	↓	■	Continuous	▬

As soon as all settings have been made:

2. Click on **Save**.



4.4.3 Selecting a pin

- i** The fields are pre-configured with a standard configuration.
The configuration can be changed as required.

The individual signal effects are triggered via bit coding. The checkboxes in the **Pin** column correspond to the 6 pins or signal inputs. Selecting one or more checkboxes indicates that these pins or signal inputs must be triggered to activate the corresponding signal effect.

Example:

Pins 1-4 must be triggered to activate the **State_01** signal effect.

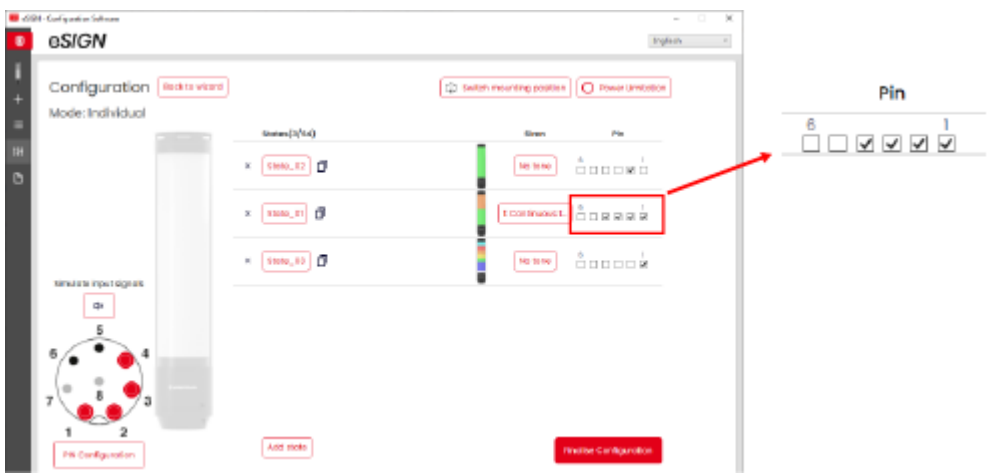

- In the **Pin** column, select the pins of the 8-pin connector on which the signal to trigger the signal effect is sent.

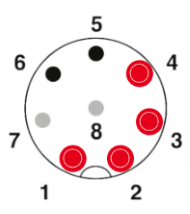
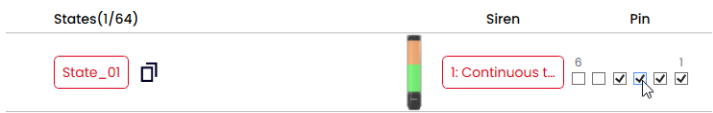

Modifying the pin configuration

If necessary, the assignment of the wire colour to the pin can be changed and a description of the signal added.

1. Click on **PIN Configuration** under the pin overview.



→ The **PIN Configuration** window appears.

PIN Configuration
✕

	Wire Colour	Description
Pin 1: Input 1	<input type="text" value="WH"/>	<input type="text"/>
Pin 2: Input 2	<input type="text" value="BN"/>	<input type="text"/>
Pin 3: Input 3	<input type="text" value="GN"/>	<input type="text"/>
Pin 4: Input 4	<input type="text" value="YE"/>	<input type="text"/>
Pin 5: Input 5	<input type="text" value="GY"/>	<input type="text"/>
Pin 6: Input 6	<input type="text" value="PK"/>	<input type="text"/>
Pin 7: COM	<input type="text" value="BU"/>	<input type="text"/>
Pin 8: +24V	<input type="text" value="RD"/>	<input type="text"/>

2. Enter the desired wire colour in the **Wire Colour** column.
3. Enter the description of the signal in the **Description** column.
4. Click on **Save**.

4.4.4 Duplicating the signal effect



Up to 64 signal effects can be configured and transferred to an eSIGN.

A signal effect consists of the individual optical settings of each segment and, if relevant, a signal tone.

1. Click on **Duplicate** in the line of the desired signal effect.



2. Configure the signal effect as described.

4.4.5 Adding a signal effect



Up to 64 signal effects can be configured and transferred to an eSIGN.

A signal effect consists of the individual optical settings of each segment and, if relevant, a signal tone.

1. Click on **Add state**.

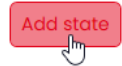

2. Configure the signal effect as described.

4.4.6 Deleting a signal effect

1. Click on **Remove** in the line of the desired signal effect.



4.4.7 Simulating signal inputs

Once all settings have been made, the signal inputs can be simulated.

1. Click on the pin that activates the desired signal effect in the pin overview.

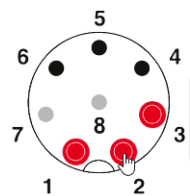

4.4.8 Finalising the configuration

1. Make additional changes to the configuration as required.
2. Once all signal effects are configured as desired, click on **Finalise**.
→ The **Finalise** window appears.

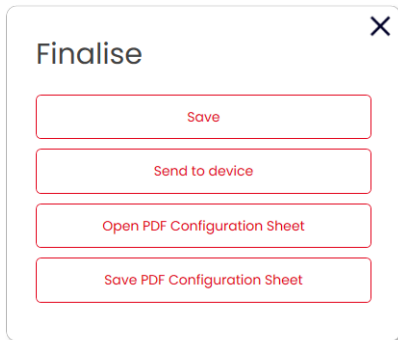

3. Click on **Save** to save the configuration in a configuration file.
4. Click on **Send to device** to transfer the configuration to the connected eSIGN.
5. Click on **Open PDF Configuration Sheet** to display an overview of the current configuration.
6. Click on **Save PDF Configuration Sheet** to save the overview of the current configuration as a PDF file.

5 Creating a configuration from sample templates

The eSIGN configuration software provides several predefined configurations that can be transferred directly to a connected eSIGN or used as a basis for your own configurations.

1. Click on **Create from templates** in the **Configuration** area.

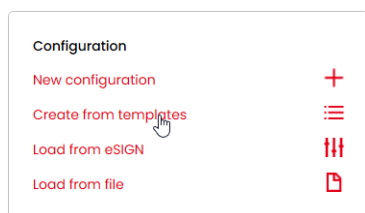

→ The **Create new configuration from templates** window appears.

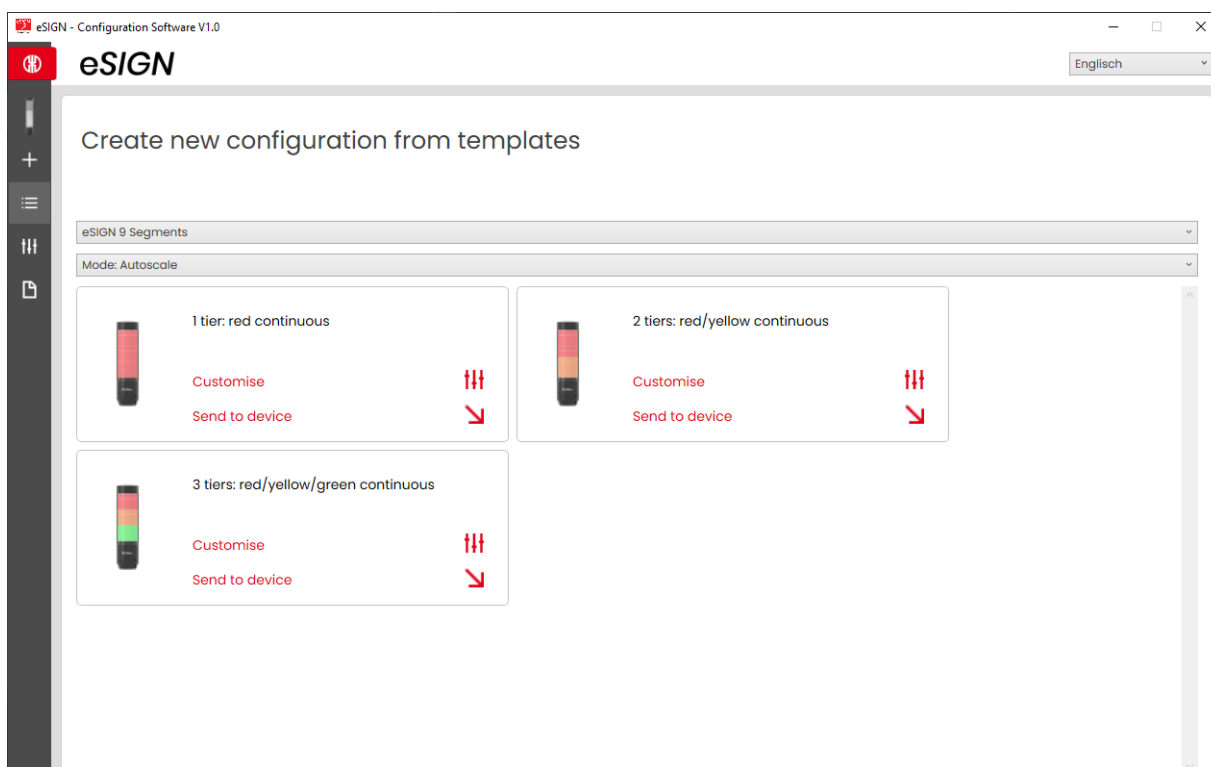

2. Select the eSIGN variant.
3. Select the mode.
→ The available templates are displayed.
4. Click on **Customise** in the desired template to load and continue editing the template.
5. Click on **Send to device** to load the template and transfer it directly to the connected eSIGN.



For more information on the configuration, see "*Creating a new configuration*", p. 115.

6 Loading the configuration of the connected eSIGN

If an eSIGN is connected to the computer, the eSIGN configuration software offers the option of opening the current configuration (if available) for editing. If no eSIGN is connected, this menu item is faded out.

1. Click on **Load from eSIGN** in the **Configuration** area.

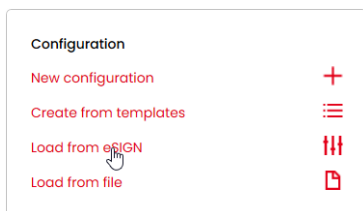

→ The **Configuration** window appears in the set mode and is already filled with the current configuration.



For more information on the configuration, see "Creating a new configuration", p. 115.

7 Opening the existing configuration

1. Click on **Load from file** in the **Configuration** area.

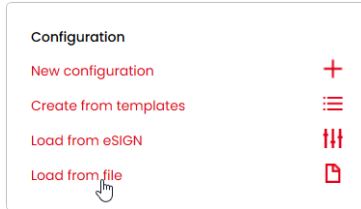

2. Select the desired configuration and click on **Open**.



Alternatively, the last used configurations can be displayed via the side menu (see "Overview", p. 113).

8 Updating eSIGN configuration software



The computer must be connected to the internet to perform a software update.

1. Click on **Check if new version available** in the This Software area.

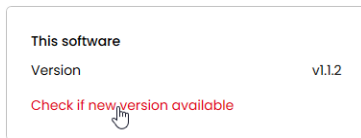

- The eSIGN configuration software checks for software updates.
- A corresponding message appears if an update is found.

9 Updating the firmware

EN

-  The computer must be connected to the internet and an eSIGN to perform a firmware update.

1. Click on **Check if new Firmware available** in the Firmware area.

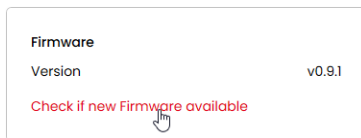

- The eSIGN configuration software checks for firmware updates for the connected eSIGN.
- A corresponding message appears if an update is found.

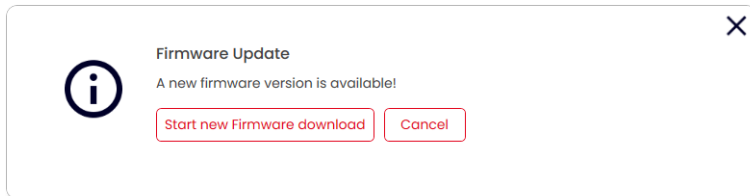

2. Click on **Start new Firmware download**.
- The new firmware is transferred to the connected eSIGN.

10 Support



WERMA Signaltechnik GmbH + Co.KG

D-78604 Rietheim-Weilheim

Support : +49 (0)7424 / 9557-222

Fax: +49 (0)7424 / 9557-44

support@werma.com

www.werma.com

Werma eSIGN - OSS- Licence agreements

INFORMATION AND COMMENTS IN RELATION TO THE OPEN SOURCE COMPONENTS USED IN THE CONFIGURATION SOFTWARE

The following list contains all Open Source components used in this application. The document includes the licence agreements under which the software is allowed to be used as well as any existing copyright notices.

This application contains the following Open Source Software components:

INFORMATION AND COMMENTS IN RELATION TO THE OPEN SOURCE

COMPONENTS USED IN THE CONFIGURATION SOFTWARE	1
I. PdfSharp.Xps.dotNet.Core.....	1
II. Newtonsoft.Json.....	2
III. NETStandard.Library.....	2
IV. Microsoft.CSharp	3
V. .NET	4
VI. NAudio	5
VII. Microsoft.Web.WebView2	6
VIII. Font "Poppins"	7
IX. HttpMachine	9
X. Sources from the main developer of this application.....	11

The following information details the relevant licence text for each Open Source software component:

I. PdfSharp.Xps.dotNet.Core

MIT License

Copyright (c) 2005-2018 empira Software GmbH, Troisdorf (Germany)

Permission is hereby granted, free of charge, to any person obtaining a copy of this software and associated documentation files (the "Software"), to deal in the Software without restriction, including without limitation the rights to use, copy, modify, merge, publish, distribute, sublicense, and/or sell copies of the Software, and to permit persons to whom the Software is furnished to do so, subject to the following conditions:

The above copyright notice and this permission notice shall be included in all copies or substantial portions of the Software.

THE SOFTWARE IS PROVIDED "AS IS", WITHOUT WARRANTY OF ANY KIND, EXPRESS OR IMPLIED, INCLUDING BUT NOT LIMITED TO THE WARRANTIES OF MERCHANTABILITY, FITNESS FOR A PARTICULAR PURPOSE AND NONINFRINGEMENT. IN NO EVENT SHALL THE AUTHORS OR COPYRIGHT HOLDERS BE LIABLE FOR ANY CLAIM, DAMAGES OR OTHER LIABILITY, WHETHER IN AN ACTION OF CONTRACT, TORT OR OTHERWISE, ARISING FROM, OUT OF OR IN CONNECTION WITH THE SOFTWARE OR THE USE OR OTHER DEALINGS IN THE SOFTWARE.

II. **Newtonsoft.Json**

The MIT License (MIT)

Copyright (c) 2007 James Newton-King

Permission is hereby granted, free of charge, to any person obtaining a copy of this software and associated documentation files (the "Software"), to deal in the Software without restriction, including without limitation the rights to use, copy, modify, merge, publish, distribute, sublicense, and/or sell copies of the Software, and to permit persons to whom the Software is furnished to do so, subject to the following conditions:

The above copyright notice and this permission notice shall be included in all copies or substantial portions of the Software.

THE SOFTWARE IS PROVIDED "AS IS", WITHOUT WARRANTY OF ANY KIND, EXPRESS OR IMPLIED, INCLUDING BUT NOT LIMITED TO THE WARRANTIES OF MERCHANTABILITY, FITNESS FOR A PARTICULAR PURPOSE AND NONINFRINGEMENT. IN NO EVENT SHALL THE AUTHORS OR COPYRIGHT HOLDERS BE LIABLE FOR ANY CLAIM, DAMAGES OR OTHER LIABILITY, WHETHER IN AN ACTION OF CONTRACT, TORT OR OTHERWISE, ARISING FROM, OUT OF OR IN CONNECTION WITH THE SOFTWARE OR THE USE OR OTHER DEALINGS IN THE SOFTWARE.

III. **NETStandard.Library**

The MIT License (MIT)

Copyright (c) .NET Foundation and Contributors

All rights reserved.

Permission is hereby granted, free of charge, to any person obtaining a copy of this software and associated documentation files (the "Software"), to deal in the Software without restriction, including without limitation the rights to use, copy, modify, merge, publish, distribute, sublicense, and/or sell copies of the Software, and to permit persons to whom the Software is furnished to do so, subject to the following conditions:

The above copyright notice and this permission notice shall be included in all copies or substantial portions of the Software.

THE SOFTWARE IS PROVIDED "AS IS", WITHOUT WARRANTY OF ANY KIND, EXPRESS OR IMPLIED, INCLUDING BUT NOT LIMITED TO THE WARRANTIES OF MERCHANTABILITY, FITNESS FOR A PARTICULAR PURPOSE AND NONINFRINGEMENT. IN NO EVENT SHALL THE AUTHORS OR COPYRIGHT HOLDERS BE LIABLE FOR ANY CLAIM, DAMAGES OR OTHER LIABILITY, WHETHER IN AN ACTION OF CONTRACT, TORT OR OTHERWISE, ARISING FROM, OUT OF OR IN CONNECTION WITH THE SOFTWARE OR THE USE OR OTHER DEALINGS IN THE SOFTWARE. THE SOFTWARE IS PROVIDED "AS IS", WITHOUT WARRANTY OF ANY KIND, EXPRESS OR IMPLIED, INCLUDING BUT NOT LIMITED TO THE WARRANTIES OF MERCHANTABILITY, FITNESS FOR A PARTICULAR PURPOSE AND NONINFRINGEMENT. IN NO EVENT SHALL THE AUTHORS OR COPYRIGHT HOLDERS BE LIABLE FOR ANY CLAIM, DAMAGES OR OTHER LIABILITY, WHETHER IN AN ACTION OF CONTRACT, TORT OR OTHERWISE, ARISING FROM, OUT OF OR IN CONNECTION WITH THE SOFTWARE OR THE USE OR OTHER DEALINGS IN THE SOFTWARE.

IV. Microsoft.CSharp

The MIT License (MIT)

Copyright (c) .NET Foundation and Contributors

All rights reserved.

Permission is hereby granted, free of charge, to any person obtaining a copy of this software and associated documentation files (the "Software"), to deal in the Software without restriction, including without limitation the rights to use, copy, modify, merge, publish, distribute, sublicense, and/or sell copies of the Software, and to permit persons to whom the Software is furnished to do so, subject to the following conditions:

The above copyright notice and this permission notice shall be included in all copies or substantial portions of the Software.

THE SOFTWARE IS PROVIDED "AS IS", WITHOUT WARRANTY OF ANY KIND, EXPRESS OR IMPLIED, INCLUDING BUT NOT LIMITED TO THE WARRANTIES OF MERCHANTABILITY, FITNESS FOR A PARTICULAR PURPOSE AND NONINFRINGEMENT. IN NO EVENT SHALL THE AUTHORS OR COPYRIGHT HOLDERS BE LIABLE FOR ANY CLAIM, DAMAGES OR OTHER LIABILITY, WHETHER IN AN ACTION OF CONTRACT, TORT OR OTHERWISE, ARISING FROM, OUT OF OR IN CONNECTION WITH THE SOFTWARE OR THE USE OR OTHER DEALINGS IN THE SOFTWARE. THE SOFTWARE IS PROVIDED "AS IS", WITHOUT WARRANTY OF ANY KIND, EXPRESS OR IMPLIED, INCLUDING BUT NOT LIMITED TO THE WARRANTIES OF MERCHANTABILITY, FITNESS FOR A PARTICULAR PURPOSE AND NONINFRINGEMENT. IN NO EVENT SHALL THE AUTHORS OR COPYRIGHT HOLDERS BE LIABLE FOR ANY CLAIM, DAMAGES OR OTHER LIABILITY, WHETHER IN AN ACTION OF CONTRACT, TORT OR OTHERWISE, ARISING FROM, OUT OF OR IN CONNECTION WITH THE SOFTWARE OR THE USE OR OTHER DEALINGS IN THE SOFTWARE.

V. .NET

The MIT License (MIT)

Copyright (c) .NET Foundation and Contributors

All rights reserved.

Permission is hereby granted, free of charge, to any person obtaining a copy of this software and associated documentation files (the "Software"), to deal in the Software without restriction, including without limitation the rights to use, copy, modify, merge, publish, distribute, sublicense, and/or sell copies of the Software, and to permit persons to

whom the Software is furnished to do so, subject to the following conditions:

The above copyright notice and this permission notice shall be included in all copies or substantial portions of the Software.

THE SOFTWARE IS PROVIDED "AS IS", WITHOUT WARRANTY OF ANY KIND, EXPRESS OR IMPLIED, INCLUDING BUT NOT LIMITED TO THE WARRANTIES OF MERCHANTABILITY, FITNESS FOR A PARTICULAR PURPOSE AND NONINFRINGEMENT. IN NO EVENT SHALL THE AUTHORS OR COPYRIGHT HOLDERS BE LIABLE FOR ANY CLAIM, DAMAGES OR OTHER LIABILITY, WHETHER IN AN ACTION OF CONTRACT, TORT OR OTHERWISE, ARISING FROM, OUT OF OR IN CONNECTION WITH THE SOFTWARE OR THE USE OR OTHER DEALINGS IN THE SOFTWARE. THE SOFTWARE IS PROVIDED "AS IS", WITHOUT WARRANTY OF ANY KIND, EXPRESS OR IMPLIED, INCLUDING BUT NOT LIMITED TO THE WARRANTIES OF MERCHANTABILITY, FITNESS FOR A PARTICULAR PURPOSE AND NONINFRINGEMENT. IN NO EVENT SHALL THE AUTHORS OR COPYRIGHT HOLDERS BE LIABLE FOR ANY CLAIM, DAMAGES OR OTHER LIABILITY, WHETHER IN AN ACTION OF CONTRACT, TORT OR OTHERWISE, ARISING FROM, OUT OF OR IN CONNECTION WITH THE SOFTWARE OR THE USE OR OTHER DEALINGS IN THE SOFTWARE.

VI. NAudio

Copyright 2020 Mark Heath

Permission is hereby granted, free of charge, to any person obtaining a copy of this software and associated documentation files (the "Software"), to deal in the Software without restriction, including without limitation the rights to use, copy, modify, merge, publish, distribute, sublicense, and/or sell copies of the Software, and to permit persons to whom the Software is furnished to do so, subject to the following conditions:

The above copyright notice and this permission notice shall be included in all copies or substantial portions of the Software.

THE SOFTWARE IS PROVIDED "AS IS", WITHOUT WARRANTY OF ANY KIND, EXPRESS OR IMPLIED, INCLUDING BUT NOT LIMITED TO THE WARRANTIES OF

MERCHANTABILITY, FITNESS FOR A PARTICULAR PURPOSE AND NON-INFRINGEMENT. IN NO EVENT SHALL THE AUTHORS OR COPYRIGHT HOLDERS BE LIABLE FOR ANY CLAIM, DAMAGES OR OTHER LIABILITY, WHETHER IN AN ACTION OF CONTRACT, TORT OR OTHERWISE, ARISING FROM, OUT OF OR IN CONNECTION WITH THE SOFTWARE OR THE USE OR OTHER DEALINGS IN THE SOFTWARE.

VII. **Microsoft.Web.WebView2**

Copyright (C) Microsoft Corporation. All rights reserved.

Redistribution and use in source and binary forms, with or without modification, are permitted provided that the following conditions are met:

- * Redistributions of source code must retain the above copyright notice, this list of conditions and the following disclaimer.

- * Redistributions in binary form must reproduce the above copyright notice, this list of conditions and the following disclaimer in the documentation and/or other materials provided with the distribution.

- * The name of Microsoft Corporation, or the names of its contributors may not be used to endorse or promote products derived from this software without specific prior written permission.

THIS SOFTWARE IS PROVIDED BY THE COPYRIGHT HOLDERS AND CONTRIBUTORS "AS IS" AND ANY EXPRESS OR IMPLIED WARRANTIES, INCLUDING, BUT NOT LIMITED TO, THE IMPLIED WARRANTIES OF MERCHANTABILITY AND FITNESS FOR A PARTICULAR PURPOSE ARE DISCLAIMED. IN NO EVENT SHALL THE COPYRIGHT OWNER OR CONTRIBUTORS BE LIABLE FOR ANY DIRECT, INDIRECT, INCIDENTAL, SPECIAL, EXEMPLARY, OR CONSEQUENTIAL DAMAGES (INCLUDING, BUT NOT LIMITED TO, PROCUREMENT OF SUBSTITUTE GOODS OR SERVICES; LOSS OF USE, DATA, OR PROFITS; OR BUSINESS INTERRUPTION) HOWEVER CAUSED AND ON ANY THEORY OF LIABILITY, WHETHER IN CONTRACT, STRICT LIABILITY, OR TORT (INCLUDING NEGLIGENCE OR OTHERWISE) ARISING IN ANY WAY OUT OF THE USE OF THIS SOFTWARE, EVEN IF ADVISED OF THE POSSIBILITY OF SUCH DAMAGE. THE SOFTWARE IS PROVIDED "AS IS", WITHOUT WARRANTY OF ANY KIND, EXPRESS OR IMPLIED, INCLUDING BUT NOT LIMITED TO THE WARRANTIES OF

MERCHANTABILITY, FITNESS FOR A PARTICULAR PURPOSE AND NON-INFRINGEMENT. IN NO EVENT SHALL THE AUTHORS OR COPYRIGHT HOLDERS BE LIABLE FOR ANY CLAIM, DAMAGES OR OTHER LIABILITY, WHETHER IN AN ACTION OF CONTRACT, TORT OR OTHERWISE, ARISING FROM, OUT OF OR IN CONNECTION WITH THE SOFTWARE OR THE USE OR OTHER DEALINGS IN THE SOFTWARE.

VIII. Font “Poppins”

Copyright 2014-2019 Indian Type Foundry (info@indiantypefoundry.com)

This Font Software is licensed under the SIL Open Font License, Version 1.1.

This license is copied below, and is also available with a FAQ at:

<http://scripts.sil.org/OFL>

SIL OPEN FONT LICENSE Version 1.1 - 26 February 2007

PREAMBLE

The goals of the Open Font License (OFL) are to stimulate worldwide development of collaborative font projects, to support the font creation efforts of academic and linguistic communities, and to provide a free and open framework in which fonts may be shared and improved in partnership with others.

The OFL allows the licensed fonts to be used, studied, modified and redistributed freely as long as they are not sold by themselves. The fonts, including any derivative works, can be bundled, embedded, redistributed and/or sold with any software provided that any reserved names are not used by derivative works. The fonts and derivatives, however, cannot be released under any other type of license. The requirement for fonts to remain under this license does not apply to any document created using the fonts or their derivatives.

DEFINITIONS

"Font Software" refers to the set of files released by the Copyright Holder(s) under this license and clearly marked as such. This may include source files, build scripts and documentation.

"Reserved Font Name" refers to any names specified as such after the copyright statement(s).

"Original Version" refers to the collection of Font Software components as distributed by the Copyright Holder(s).

"Modified Version" refers to any derivative made by adding to, deleting, or substituting -- in part or in whole -- any of the components of the Original Version, by changing formats or by porting the Font Software to a new environment.

"Author" refers to any designer, engineer, programmer, technical writer or other person who contributed to the Font Software.

PERMISSION & CONDITIONS

Permission is hereby granted, free of charge, to any person obtaining a copy of the Font Software, to use, study, copy, merge, embed, modify, redistribute, and sell modified and unmodified copies of the Font Software, subject to the following conditions:

- 1) Neither the Font Software nor any of its individual components, in Original or Modified Versions, may be sold by itself.
- 2) Original or Modified Versions of the Font Software may be bundled, redistributed and/or sold with any software, provided that each copy contains the above copyright notice and this license. These can be included either as stand-alone text files, human-readable headers or in the appropriate machine-readable metadata fields within text or binary files as long as those fields can be easily viewed by the user.
- 3) No Modified Version of the Font Software may use the Reserved Font Name(s) unless explicit written permission is granted by the corresponding Copyright Holder. This restriction only applies to the primary font name as presented to the users.

4) The name(s) of the Copyright Holder(s) or the Author(s) of the Font Software shall not be used to promote, endorse or advertise any Modified Version, except to acknowledge the contribution(s) of the Copyright Holder(s) and the Author(s) or with their explicit written permission.

5) The Font Software, modified or unmodified, in part or in whole, must be distributed entirely under this license, and must not be distributed under any other license. The requirement for fonts to remain under this license does not apply to any document created using the Font Software.

TERMINATION

This license becomes null and void if any of the above conditions are not met.

DISCLAIMER

THE FONT SOFTWARE IS PROVIDED "AS IS", WITHOUT WARRANTY OF ANY KIND, EXPRESS OR IMPLIED, INCLUDING BUT NOT LIMITED TO ANY WARRANTIES OF MERCHANTABILITY, FITNESS FOR A PARTICULAR PURPOSE AND NONINFRINGEMENT OF COPYRIGHT, PATENT, TRADEMARK, OR OTHER RIGHT. IN NO EVENT SHALL THE COPYRIGHT HOLDER BE LIABLE FOR ANY CLAIM, DAMAGES OR OTHER LIABILITY, INCLUDING ANY GENERAL, SPECIAL, INDIRECT, INCIDENTAL, OR CONSEQUENTIAL DAMAGES, WHETHER IN AN ACTION OF CONTRACT, TORT OR OTHERWISE, ARISING FROM, OUT OF THE USE OR INABILITY TO USE THE FONT SOFTWARE OR FROM OTHER DEALINGS IN THE FONT SOFTWARE.

IX. HttpMachine

HttpMachine - Copyright (c) 2011 Benjamin van der Veen

Permission is hereby granted, free of charge, to any person obtaining a copy of this software and associated documentation files (the "Software"), to deal in the Software without restriction, including without limitation the rights to use, copy, modify, merge, publish, distribute, sublicense, and/or sell copies of the Software, and to permit persons to whom the Software is furnished to do so, subject to the following conditions:

The above copyright notice and this permission notice shall be included in all copies or substantial portions of the Software.

THE SOFTWARE IS PROVIDED "AS IS", WITHOUT WARRANTY OF ANY KIND, EXPRESS OR IMPLIED, INCLUDING BUT NOT LIMITED TO THE WARRANTIES OF MERCHANTABILITY, FITNESS FOR A PARTICULAR PURPOSE AND NONINFRINGEMENT. IN NO EVENT SHALL THE AUTHORS OR COPYRIGHT HOLDERS BE LIABLE FOR ANY CLAIM, DAMAGES OR OTHER LIABILITY, WHETHER IN AN ACTION OF CONTRACT, TORT OR OTHERWISE, ARISING FROM, OUT OF OR IN CONNECTION WITH THE SOFTWARE OR THE USE OR OTHER DEALINGS IN THE SOFTWARE.

X. Sources from the main developer of this application

Copyright (c) 2022 Bett Ingenieure GmbH

Copyright (c) 2022 Fabian Bett

Permission is hereby granted, free of charge, to any person obtaining a copy of this software and associated documentation files (the "Software"), to deal in the Software without restriction, including without limitation the rights to use, copy, modify, merge, publish, distribute, sublicense, and/or sell copies of the Software, and to permit persons to whom the Software is furnished to do so, subject to the following conditions:

The above copyright notice and this permission notice shall be included in all copies or substantial portions of the Software.

THE SOFTWARE IS PROVIDED "AS IS", WITHOUT WARRANTY OF ANY KIND, EXPRESS OR IMPLIED, INCLUDING BUT NOT LIMITED TO THE WARRANTIES OF MERCHANTABILITY, FITNESS FOR A PARTICULAR PURPOSE AND NONINFRINGEMENT. IN NO EVENT SHALL THE AUTHORS OR COPYRIGHT HOLDERS BE LIABLE FOR ANY CLAIM, DAMAGES OR OTHER LIABILITY, WHETHER IN AN ACTION OF CONTRACT, TORT OR OTHERWISE, ARISING FROM, OUT OF OR IN CONNECTION WITH THE SOFTWARE OR THE USE OR OTHER DEALINGS IN THE SOFTWARE.



**SCATTERGOOD
& JOHNSON LTD**
ELECTRICAL ENGINEERING & FLUID CONTROL DISTRIBUTORS

Est.1899

At Scattergood & Johnson Ltd, we pride ourselves on being a technical distributor to specialist industries.

Working with a range of quality product manufacturers across a number of specialist markets, we are not your average 'box shifter' - we are your technical and supply chain partner.

We fully support every product we sell - for free! Our internal team and external sales engineers can answer any product or application question, no matter the complexity.

Backing up this technical ability is a range of 50,000+ products available from stock for nationwide next day delivery (same day if required!), or you can collect what you need from any of our trade counters around the UK.

Select your specialist interest below to learn more about how we can help.

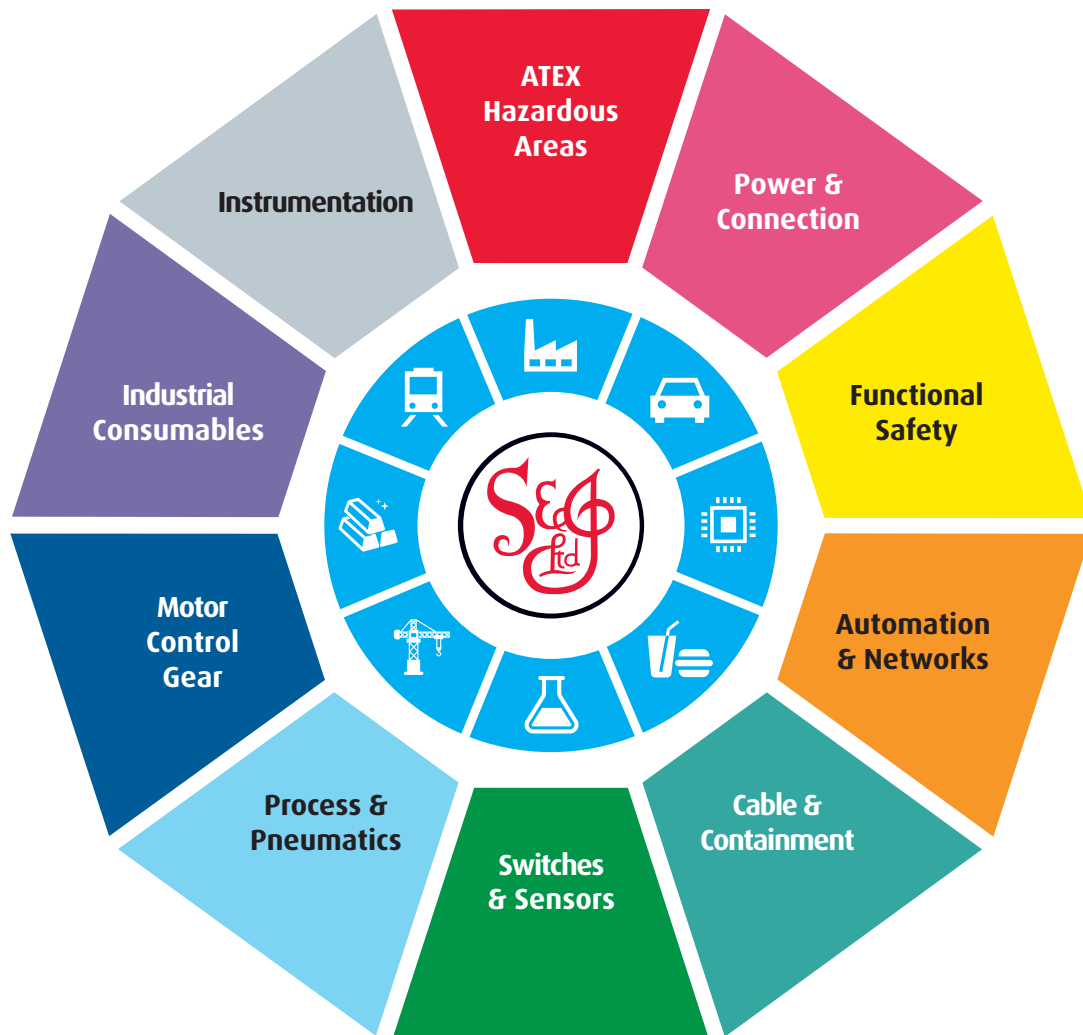

Online, In Branch and On the Road - Scattergood & Johnson Ltd, there when you need us.

www.scatts.co.uk