

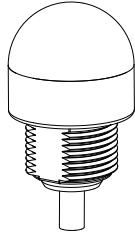

K30 Pro Indicator

Datasheet

30 mm Programmable Multicolor RGB Indicator with Flashing Input Control



- Bright, uniform indicator light
- Seven default colors in one device (Green, Red, Yellow, Blue, White, Cyan, Magenta)
- Programmable using Banner's Pro Editor software and Pro Converter Cable
- 22 mm threaded polycarbonate base
- Translucent polycarbonate dome
- Rugged IP67, IP69K per DIN 40050-9, UL Type 12, and UL Type 4X and UL Type 13 design
- Bimodal inputs (PNP/NPN), depending on source wiring
- All models have flashing input control
- Variety of connector options
- Terminal connection models available for panel wiring applications

Pro Editor

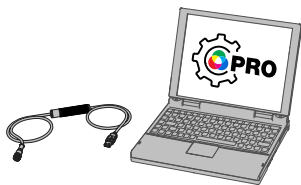

Use Banner's Pro Editor software and Pro Converter Cable to create custom configurations by selecting different colors, flash patterns, and animations.
For more information visit www.bannerengineering.com/proeditor.

Models

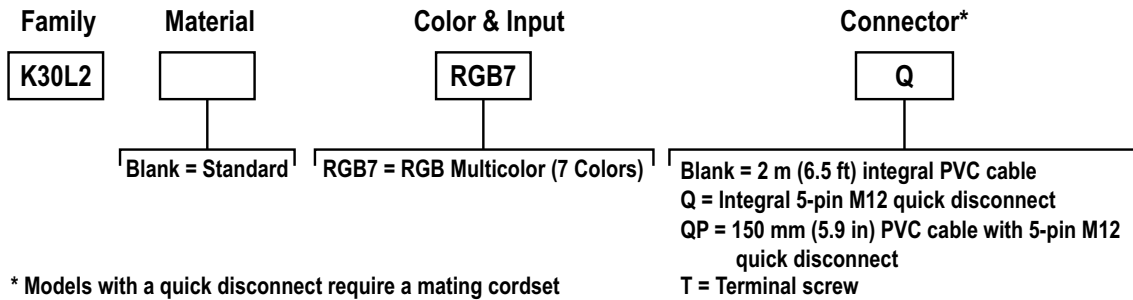

Wiring Diagrams

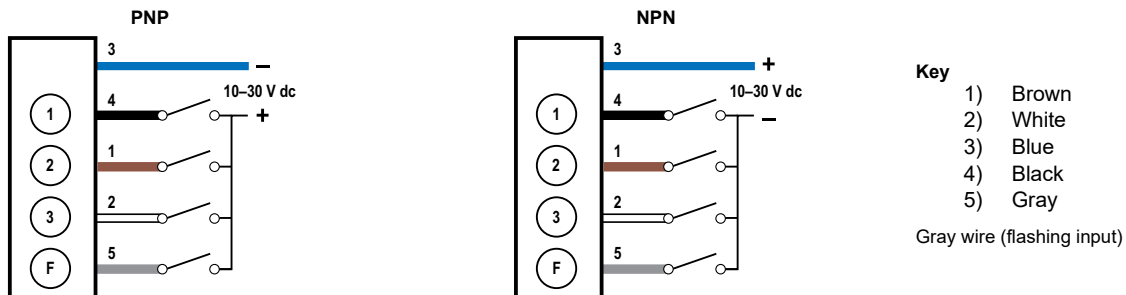

Table 1: Default Color Definition

	Red	Yellow	Green	Cyan	Blue	Magenta	White
Input 1	X	X				X	X
Input 2		X	X	X			X
Input 3				X	X	X	X

An "X" denotes an active input, for example when Input 1 and Input 3 are active, the indicator will show Magenta.

Specifications

Supply Voltage and Current

10 V DC to 30 V DC

- 60 mA at 10 V DC
- 50 mA at 12 V DC
- 35 mA at 24 V DC
- 30 mA at 30 V DC

Supply Protection

Protected against reverse polarity and transient voltages

Leakage Current Immunity

400 μ A

Input Response Time

250 milliseconds maximum

Flash

Default 1.5 Hz flash rate through flash input wire

Connections

Integral 5-pin M12 male quick-disconnect connector, 150 mm (6 in) PVC-jacketed cable with an M12 quick disconnect, or 2 m (6.5 ft) integral PVC-jacketed cable, depending on model
Models with a quick disconnect require a mating cordset

Mounting

M22 by 1.5 threaded base, maximum torque 2.25 N·m (20 inch-ibf)
Mounting nut included

Construction

Base, Dome, and Nut: Polycarbonate

Vibration and Mechanical Shock

Meets IEC 60068-2-6 requirements (Vibration: 10 Hz to 55 Hz, 1.0 mm amplitude, 5 minutes sweep, 30 minutes dwell)

Meets IEC 60068-2-27 requirements (Shock: 30G 11 ms duration, half sine wave)

Operating Conditions

-40 °C to +50 °C (-40 °F to +122 °F)

90% at +50 °C maximum relative humidity (non-condensing)

Storage Temperature: -40 °C to +70 °C (-40 °F to +158 °F)

Environmental Rating

IP67, IP69K per DIN 40050-9. Cabled models also meet IP69K per DIN 40050-9 if the cable and cable entrance are protected from high-pressure spray. Indicator side of terminal models meet IP69K per DIN 40050-9 when installed in an enclosure.

Screw connection points meet IP00.

Meets UL Type 12.

Meets UL Type 4X and UL Type 13 when used in a suitable enclosure.

Pro Editor Configuration

Connection to Pro Editor software enables control of:

- **Animation:** On, Flash, Two Color Flash, 50/50, 50/50 Rotate, Chase, Intensity Sweep, Color Sweep, Sequence, Wave, Double Wave
- **Color:** Green, Red, Yellow, Blue, White, Cyan, Magenta, Amber, Rose, Lime Green, Orange, Sky Blue, Violet, Spring Green
- **Intensity:** Low, Medium, High
- **Speed:** Slow, Standard, Fast

Pro Converter Cable required to interface between PC and indicator, see accessories

Default Indicator Characteristics

Color	Dominant Wavelength (nm) or Color Temperature (CCT)	Color Coordinates ^a		Lumen Output (Typical at 25 °C)
		x	y	
Green	522	0.154	0.700	7.7
Red	620	0.689	0.309	3.1
Yellow	576	0.467	0.463	7.8
Blue	466	0.140	0.054	1.7
White	5700K	0.328	0.337	9.6
Cyan	493	0.157	0.331	8.7
Magenta	–	0.392	0.186	4.2
Amber	589	0.556	0.420	5.8
Rose	–	0.525	0.237	3.5
Lime Green	562	0.383	0.523	10
Sky Blue	486	0.145	0.240	9.2
Orange	599	0.616	0.370	4.6
Violet	–	0.224	0.099	3.4
Spring Green	508	0.155	0.524	8

a. Refer to the CIE 1931 (x,y) Chromaticity Diagram to show equivalent color with indicated color coordinates. Actual coordinates may differ \pm 10%.

Required Overcurrent Protection

WARNING: Electrical connections must be made by qualified personnel in accordance with local and national electrical codes and regulations.

Overcurrent protection is required to be provided by end product application per the supplied table.
Overcurrent protection may be provided with external fusing or via Current Limiting, Class 2 Power Supply.
Supply wiring leads < 24 AWG shall not be spliced.
For additional product support, go to www.bannerengineering.com.

Supply Wiring (AWG)	Required Overcurrent Protection (A)	Supply Wiring (AWG)	Required Overcurrent Protection (A)
20	5.0	26	1.0
22	3.0	28	0.8
24	1.0	30	0.5

Certifications



Banner Engineering BV Park Lane, Culliganlaan
2F bus 3, 1831 Diegem, BELGIUM



Turck Banner LTD Blenheim House, Blenheim
Court, Wickford, Essex SS11 8YT, Great Britain



FCC Part 15 Class B

This equipment has been tested and found to comply with the limits for a Class B digital device, pursuant to part 15 of the FCC Rules. These limits are designed to provide reasonable protection against harmful interference in a residential installation. This equipment generates, uses and can radiate radio frequency energy and, if not installed and used in accordance with the instructions, may cause harmful interference to radio communications. However, there is no guarantee that interference will not occur in a particular installation. If this equipment does cause harmful interference to radio or television reception, which can be determined by turning the equipment off and on, the user is encouraged to try to correct the interference by one or more of the following measures:

- Reorient or relocate the receiving antenna.
- Increase the separation between the equipment and receiver.
- Connect the equipment into an outlet on a circuit different from that to which the receiver is connected.
- Consult the dealer or an experienced radio/TV technician for help.

Industry Canada

This device complies with CAN ICES-3 (B)/NMB-3(B). Operation is subject to the following two conditions: 1) This device may not cause harmful interference; and 2) This device must accept any interference received, including interference that may cause undesired operation.

Cet appareil est conforme à la norme NMB-3(B). Le fonctionnement est soumis aux deux conditions suivantes : (1) ce dispositif ne peut pas occasionner d'interférences, et (2) il doit tolérer toute interférence, y compris celles susceptibles de provoquer un fonctionnement non souhaité du dispositif.

Dimensions

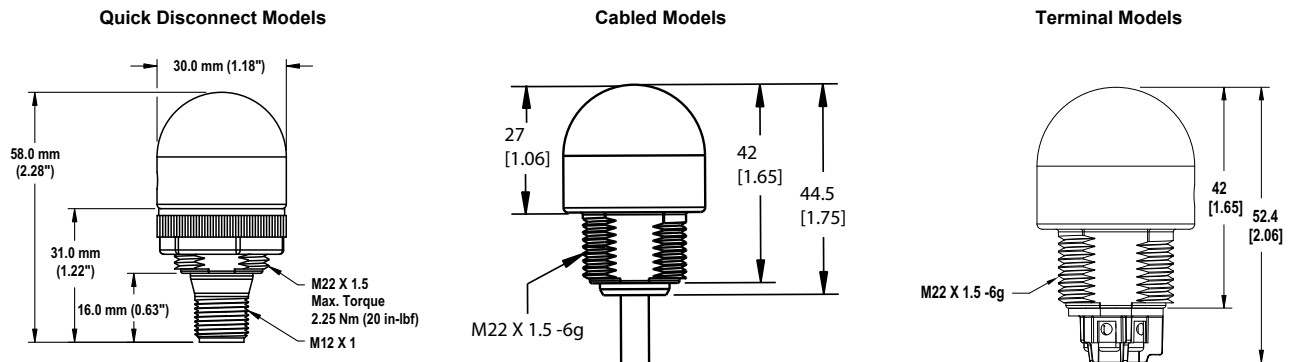

Accessories

Pro Editor Hardware

MQDC-506-USB

- Pro Converter Cable
- 1.83 m (6 ft) length 5-pin M12 quick disconnect to Device and USB to PC
- Required for connection to Pro Editor

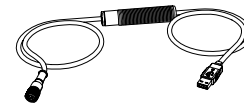

CSB-M1251FM1251M

- 5-pin parallel Y splitter (Male-Male-Female)
- For full Pro Editor preview capability
- Requires external power supply, sold separately

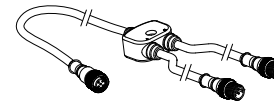

PSW-24-1

- 24 V DC, 1 A power supply
- 2 m (6.5 ft) PVC cable with M12 quick disconnect
- Provides external power with splitter cable, sold separately



ACC-PRO-CABLE5

- Mating accessory for cabled and terminal models
- 150 mm (6 inch) PVC cable with M12 quick disconnect
- Lever wire nuts included (qty 5)
- Required to connect cabled models and screw terminal models to Pro Converter Cable, sold separately

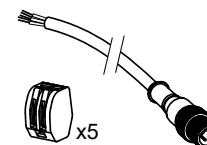

Cordsets

5-Pin Threaded M12 Cordsets—Single Ended

Model	Length	Style	Dimensions	Pinout (Female)
MQDC1-501.5	0.5 m (1.5 ft)	Straight		<ul style="list-style-type: none"> • 1 = Brown • 2 = White • 3 = Blue • 4 = Black • 5 = Gray
MQDC1-503	0.9 m (2.9 ft)			
MQDC1-506	2 m (6.5 ft)			
MQDC1-515	5 m (16.4 ft)			
MQDC1-530	9 m (29.5 ft)			
MQDC1-560	18 m (59 ft)			
MQDC1-506RA	2 m (6.5 ft)	Right-Angle		<ul style="list-style-type: none"> • 1 = Brown • 2 = White • 3 = Blue • 4 = Black • 5 = Gray
MQDC1-515RA	5 m (16.4 ft)			
MQDC1-530RA	9 m (29.5 ft)			
MQDC1-560RA	19 m (62.3 ft)			

5-Pin Threaded M12 Washdown Cordsets with Shield—Single Ended

Model	Length	Style	Dimensions	Pinout (Female)
MQDCWD-506	2 m (6.56 ft)	Straight		<ul style="list-style-type: none"> • 1 = Brown • 2 = White • 3 = Blue • 4 = Black • 5 = Gray
MQDCWD-530	9 m (29.5 ft)			

Splitter Cables for Use with IO-Blocks

5-Pin Threaded M12 to 4-Pin Threaded M12 Combiner Cordset with Flat Junction

Model	Branches (Male)	Trunk (Female)	Pinout Key
CSF-M12F51M12M41	4-pin Quick Disconnect, 2 × 0.31 m (1.02 ft) 	5-pin Quick Disconnect, 0.31 m (1.02 ft) 	<p>Trunk</p> <ul style="list-style-type: none"> • 1 = Brown • 2 = White • 3 = Blue • 4 = Black • 5 = Gray <p>Branch 1</p> <ul style="list-style-type: none"> • 1 = NC • 2 = Brown • 3 = Blue • 4 = Black <p>Branch 2</p> <ul style="list-style-type: none"> • 1 = NC • 2 = Gray • 3 = Blue • 4 = White

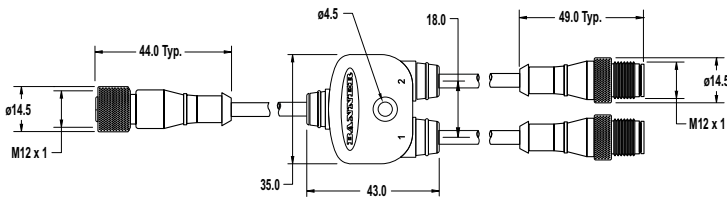

Brackets

SMB22A

- Right-angle bracket with curved slot for versatile orientation
- 12-ga. stainless steel
- Mounting hole for 22 mm sensor

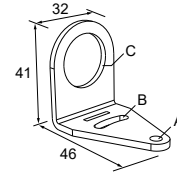

Hole center spacing: A to B = 26.0

Hole size: A = \varnothing 4.6, B = 4.6 x 16.9, C = 22.2

SMB22FVK

- V-clamp, flat bracket and fasteners for mounting to pipe or extensions
- Clamp accommodates 28 mm diameter tubing or 1 in. square extrusions
- 22 mm hole for mounting sensor

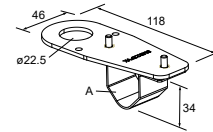

Hole size: A = \varnothing 22.5

SMB22RAVK

- V-clamp, right-angle bracket and fasteners for mounting to pipe or extensions
- Clamp accommodates 28 mm diameter tubing or 1 in. square extrusions
- 22 mm hole for mounting sensor

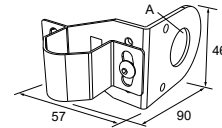

Hole size: A = \varnothing 22.5

SMBAMS22P

- Flat SMBAMS series bracket with 22 mm hole for mounting sensors
- Articulation slots for 90+° rotation
- 12-ga. (2.6 mm) cold-rolled steel

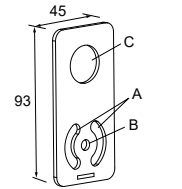

Hole center spacing: A = 26.0, A to B = 13.0

Hole size: A = 26.8 x 7.0, B = \varnothing 6.5, C = \varnothing 22.5

SMBAMS22RA

- Right-angle SMBAMS series bracket with 22 mm hole for mounting sensors
- Articulation slots for 90+° rotation
- 12-ga. (2.6 mm) cold-rolled steel

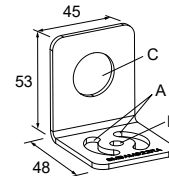

Hole center spacing: A = 26.0, A to B = 13.0

Hole size: A = 26.8 x 7.0, B = \varnothing 6.5, C = \varnothing 22.5

LMB22LPC

- For 28 mm tubular racking
- Toolless mount to racking
- 22 mm mounting hole

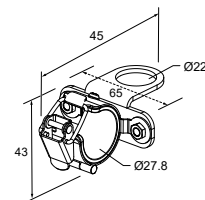

Banner Engineering Corp. Limited Warranty

Banner Engineering Corp. warrants its products to be free from defects in material and workmanship for one year following the date of shipment. Banner Engineering Corp. will repair or replace, free of charge, any product of its manufacture which, at the time it is returned to the factory, is found to have been defective during the warranty period. This warranty does not cover damage or liability for misuse, abuse, or the improper application or installation of the Banner product.

THIS LIMITED WARRANTY IS EXCLUSIVE AND IN LIEU OF ALL OTHER WARRANTIES WHETHER EXPRESS OR IMPLIED (INCLUDING, WITHOUT LIMITATION, ANY WARRANTY OF MERCHANTABILITY OR FITNESS FOR A PARTICULAR PURPOSE), AND WHETHER ARISING UNDER COURSE OF PERFORMANCE, COURSE OF DEALING OR TRADE USAGE.

This Warranty is exclusive and limited to repair or, at the discretion of Banner Engineering Corp., replacement. **IN NO EVENT SHALL BANNER ENGINEERING CORP. BE LIABLE TO BUYER OR ANY OTHER PERSON OR ENTITY FOR ANY EXTRA COSTS, EXPENSES, LOSSES, LOSS OF PROFITS, OR ANY INCIDENTAL, CONSEQUENTIAL OR SPECIAL DAMAGES RESULTING FROM ANY PRODUCT DEFECT OR FROM THE USE OR INABILITY TO USE THE PRODUCT, WHETHER ARISING IN CONTRACT OR WARRANTY, STATUTE, TORT, STRICT LIABILITY, NEGLIGENCE, OR OTHERWISE.**

Banner Engineering Corp. reserves the right to change, modify or improve the design of the product without assuming any obligations or liabilities relating to any product previously manufactured by Banner Engineering Corp. Any misuse, abuse, or improper application or installation of this product or use of the product for personal protection applications when the product is identified as not intended for such purposes will void the product warranty. Any modifications to this product without prior express approval by Banner Engineering Corp will void the product warranties. All specifications published in this document are subject to change; Banner reserves the right to modify product specifications or update documentation at any time. Specifications and product information in English supersede that which is provided in any other language. For the most recent version of any documentation, refer to: www.bannerengineering.com.

For patent information, see www.bannerengineering.com/patents.

Document title: K30 Pro Indicator

Part number: 197814

Revision: H

Original Instructions

© Banner Engineering Corp. All rights reserved.





**SCATTERGOOD
& JOHNSON LTD**
ELECTRICAL ENGINEERING & FLUID CONTROL DISTRIBUTORS

Est.1899

At Scattergood & Johnson Ltd, we pride ourselves on being a technical distributor to specialist industries.

Working with a range of quality product manufacturers across a number of specialist markets, we are not your average 'box shifter' - we are your technical and supply chain partner.

We fully support every product we sell - for free! Our internal team and external sales engineers can answer any product or application question, no matter the complexity.

Backing up this technical ability is a range of 50,000+ products available from stock for nationwide next day delivery (same day if required!), or you can collect what you need from any of our trade counters around the UK.

Select your specialist interest below to learn more about how we can help.



Online, In Branch and On the Road - Scattergood & Johnson Ltd, there when you need us.

www.scatts.co.uk