

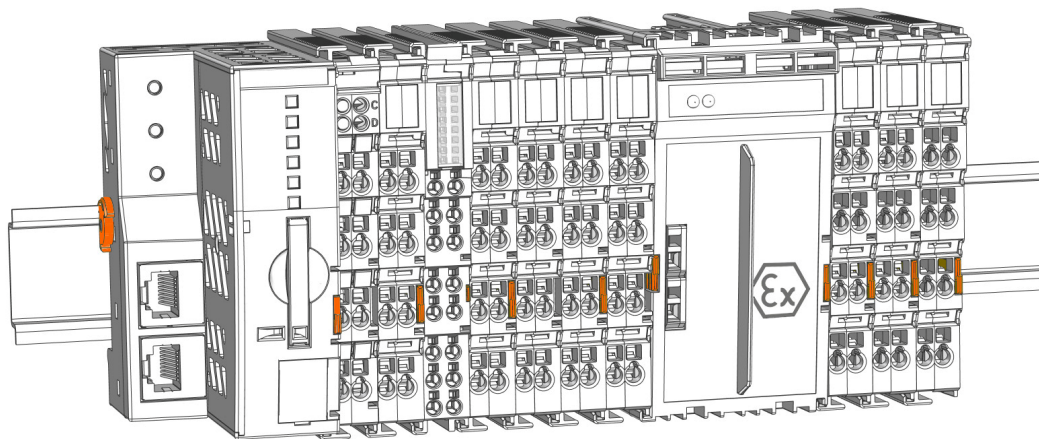

WAGO I/O System 750

Decentralized Automation Technology

Serie 750, 753



System manual | Version 3.1.0

© 2022 WAGO GmbH & Co. KG
All rights reserved.

WAGO GmbH & Co. KG

Hansastraße 27
D - 32423 Minden

Phone: +49 571/887 – 0
Fax: +49 571/887 – 844169
E-Mail: ✉ info@wago.com
Internet: 🌐 www.wago.com

Technical Support

Phone: +49 571/887 – 44555
Fax: +49 571/887 – 844555
E-Mail: ✉ support@wago.com

Every conceivable measure has been taken to ensure the accuracy and completeness of this documentation. However, as errors can never be fully excluded, we always appreciate any information or suggestions for improving the documentation.

E-Mail: ✉ documentation@wago.com

We wish to point out that the software and hardware terms as well as the trademarks of companies used and/or mentioned in the present manual are generally protected by trademark or patent.

WAGO is a registered trademark of WAGO Verwaltungsgesellschaft mbH.

Table of Contents

Provisions	5
1.1 Intended Use.....	5
1.2 Typographical Conventions.....	6
1.3 Legal Information	8
Safety	9
2.1 General Safety Regulations	9
2.2 Electrical Safety.....	9
2.3 Mechanical Safety.....	10
2.4 Thermal Safety.....	10
2.5 Indirect Safety	10
System Features	11
3.1 Component Structure	11
3.1.1 Component Designs	11
3.1.2 Structure of the Head Stations	12
3.1.3 I/O Module Configuration	14
3.1.4 Product Identification.....	17
3.1.4.1 Versions.....	17
3.1.4.2 Marking Example.....	18
3.1.4.3 Identification	20
3.1.4.4 Update Matrix	20
3.1.5 System Contacts	20
3.1.5.1 Data Contacts.....	20
3.1.5.2 Power Jumper Contacts	21
3.1.5.3 DIN-Rail Contact.....	21
3.1.6 Coding Keys	22
3.1.7 Marking Elements.....	22
3.2 Electrical Structure	22
3.2.1 Potential Groups.....	22
3.2.2 System Supply	23
3.2.3 Field Supply.....	25
3.2.4 Power Supply Components.....	25
Functions	27
4.1 Process Image	27
Planning	28
5.1 Node Structure	28
5.2 Structure Guidelines.....	28
5.2.1 Installation Site and Touch-Proof Protection	28
5.2.2 Overcurrent Protection	29
5.2.3 Ground Conductor.....	29
5.2.4 Buffering	29
5.2.5 Mounting Position.....	29
5.2.6 DIN-Rail Characteristics	31

5.2.7	EMC Installations	31
5.2.8	Data Security	32
5.3	Designing the System Supply	33
5.4	Field Supply Layout.....	33
5.5	Special Applications and Environments	34
5.5.1	Marine and Offshore.....	34
5.5.2	Ex i Applications	36
5.5.3	Marine and Offshore Ex i Applications	38
5.5.4	Functional Safety.....	39
5.5.4.1	Power Supply Concept.....	39
5.6	Examples and Aids.....	40
5.6.1	Aids	40
5.6.2	I/O Test.....	42
	Transport and Storage.....	43
	Assembly and Disassembly.....	44
7.1	Assembly Sequence	44
7.2	Snapping the Head Station to the DIN-Rail.....	44
7.3	Attaching an I/O Module.....	45
7.4	Removing a Head Station from the DIN-Rail	46
7.5	Removing the I/O Module	47
7.6	Assembling/Disassembling Components.....	49
7.6.1	Inserting Coding Keys	49
	Conductor Termination	51
8.1	Connect Conductor to CAGE CLAMP®	51
	Decommissioning	52
9.1	Shutting Down	52
9.2	Disposal and Recycling	52
	Appendix.....	53
10.1	Installation Regulations Specified by Approvals	53
10.2	Protected Rights.....	55

Provisions

This document applies to the I/O system:

WAGO I/O System 750/753 (Series 750, 753).

The complete user manual for the I/O system consists of several documents. The I/O system must only be installed and operated according to the instructions of the complete operating instructions. Knowledge of the entire operating instructions is required for proper use.

Please find all documents and information at:

 www.wago.com/de/c/io-systeme.

Applicable documents

-  **Product manuals**

1.1 Intended Use

The I/O system is used to receive digital and analog signals from sensors and to control actuators. Higher-level controllers can be communicated with through fieldbus interfaces. The signals can be (pre-)processed with the controllers.

The products are open equipment and are designed for installation in an additional enclosure. Protective measures suitable for the specific application area and application must be implemented.

- The products are intended for installation in automation technology systems.
- The products are designed for use in dry indoor rooms.
- Operation of the products in industrial areas is permitted.
- The products used fulfill the EMC requirements for large and small commercial and business areas as well as residential areas when they maintain the required limits for electromagnetic interference emission (EMC).
- Operation of the product in other application areas is only permitted when corresponding approvals and labeling are present.

Improper Use

Improper use of the products is not permitted. Specifically, improper use occurs in the following cases:

- Non-observance of the intended use
- Use without protective measures in an environment in which moisture, salt water, salt spray mist, dust, corrosive fumes, gases, direct sunlight or ionizing radiation can occur
- Use of the products in areas with special risk that require flawless continuous operation and in which failure or operation of the product can result in an imminent risk to life, limb or health or cause serious damage to property or the environment (such as the operation of nuclear power plants, weapon systems, aircraft and motor vehicles)

Warranty and Liability

The terms set forth in the General Business & Contract Conditions for Delivery and Service of WAGO GmbH & Co. KG and the terms for software products and products with integrated software stated in the WAGO Software License Contract – both available at

 www.wago.com – shall apply. In particular, the warranty is void if:

- The products are used improperly.
- The deficiency (hardware and software configurations) is due to special instructions.
- Modifications to the hardware or software have been made by the user or third parties that are not described in this documentation and that has contributed to the fault.

Individual agreements always have priority.

Obligations of Installers/Operators

The installers and operators bear responsibility for the safety of an installation or a system assembled with the products. The installer/operator is responsible for proper installation and safety of the system. All laws, standards, guidelines, local regulations and accepted technology standards and practices applicable at the time of installation, and the instructions in the the products' Instructions for Use, must be complied with. In addition, the Installation regulations specified by Approvals must be observed. In the event of non-compliance, the products may not be operated within the scope of the approval.

1.2 Typographical Conventions





Number Notation

100	Decimals: Normal notation
0x64	Hexadecimals: C-notation
'100'	Binary: In single quotation marks
'0110.0100'	Nibbles separated by a period

Text Formatting

<i>italic</i>	Names of paths or files
bold	Menu items, entry or selection fields, emphasis
Code	Sections of program code
>	Selection of a menu point from a menu
"Value"	Value entries
[F5]	Identification of buttons or keys

Cross References / Links

	Cross references/links to a topic in a document
	Cross references / links to a separate document
	Cross references / links to a website
	Cross references / links to an email address

Action Instructions

- ✓ This symbol identifies a precondition.
1. Action step

2. Action step

⇒ This symbol identifies an intermediate result.

⇒ This symbol identifies the result of an action.

Lists

- Lists, first level
 - Lists, second level

Figures

Figures in this documentation are for better understanding and may differ from the actual product design.

Notes** DANGER****Type and source of hazard**

Possible consequences of hazard that also include death or irreversible injury

- Action step to reduce risk

 WARNING**Type and source of hazard**

Possible consequences of hazard that also include severe injury

- Action step to reduce risk

 CAUTION**Type and source of hazard**

Possible consequences of hazard that include at least slight injury

- Action step to reduce risk

 NOTICE**Type and source of malfunction (property damage only)**

Possible malfunctions that may restrict the product's scope of functions or ergonomics, but do not lead to foreseeable risks to persons

- Action step to reduce risk

 Note**Notes and information**

Indicates information, clarifications, recommendations, referrals, etc.

1.3 Legal Information

Intellectual Property

Unless barred by applicable legal provisions, unauthorized copying and distribution of this document, as well as the use and communication of its content are strictly prohibited unless expressly authorized by prior agreement. Third-party products are always mentioned without any reference to patent rights. WAGO GmbH & Co. KG, or for third-party products, their manufacturer, retain all rights regarding patent, utility model or design registration.

Third-party trademarks are referred to in the product documentation. The “®” and “™” symbols are omitted hereinafter. The trademarks are listed in the Appendix ( **Protected Rights [▶ 55]**).

Subject to Change

The instructions, guidelines, standards, etc., in this manual correspond to state of the art at the time the documentation was created and are not subject to updating service. The installer and operator bear sole responsibility to ensure they are complied with in their currently applicable form. WAGO GmbH & Co. KG retains the right to carry out technical changes and improvements of the products and the data, specifications and illustrations of this manual. All claims for change or improvement of products that have already been delivered – excepting change or improvement performed under guarantee agreement – are excluded.

Licenses

The products may contain open-source software. The requisite license information is saved in the products. This information is also available under  www.wago.com.

Safety

2.1 General Safety Regulations

- This documentation is part of the Products. Retain the documentation for the entire service life of the Products. Pass on the documentation to any subsequent user of the Products. In addition, ensure that any supplement to this documentation is included, if necessary.
- The Products must only be installed and put into operation by qualified electrical specialists per EN 50110-1/-2 and IEC 60364.
- Comply with the laws, standards, guidelines, local regulations and accepted technology standards and practices applicable at the time of installation.

2.2 Electrical Safety

- Make sure the products do not carry any voltage before starting work.

Power supply

- Use safe extra-low voltage with separation (SELV, PELV) for all voltages with a nominal value of 24 VDC.
- When configuring the system, make sure that the maximum total current of the field supply of the node is not exceeded. Where needed, include an additional supply module.
- When configuring the system, make sure that the maximum total current of the system supply of the node is not exceeded. Where needed, include an additional supply module.
- Connecting impermissible current or frequency values may destroy the products.
- Plan for voltage buffering if the requirement for voltage buffering according to EN 61131-2 is to be met.
- Take suitable measures to protect against overload (e.g., a supply module with fuse or an external fuse).
- In mixed operation, always separate the areas in the XTR version and the areas with the standard version with the separate potential supply modules for the field supply and separate power supply units of the respective version in different potential groups. Do not mix the versions within these potential groups.

Grounding/Protection/Fuses

- Establish sufficient grounding. Make sure there is a flawless electrical connection between the DIN-rail and frame / additional enclosure.
- For UL-approved systems, use fuses with UL approval only .

Cables

- Maintain spacing between control, signal and data lines and the power supply lines.
- Observe permissible temperature range of connecting cables.
- You must only connect one conductor to each clamping unit.

Protection

- When working on the system (e.g., during maintenance), protect the facility part in question from accidental or unauthorized restart.

2.3 Mechanical Safety

- Before start-up, check the product for any damage that may have occurred during shipping. Do not put the product into operation if there is any mechanical damage.
- Do not open the product housing.
- Do not touch the power jumper contacts.
- Avoid conductive contamination.

2.4 Thermal Safety

- The temperature inside the additional enclosure must not exceed the surrounding air temperature permitted for the mounted products.
- The conductor cross-sections must be designed for the maximum load current.

2.5 Indirect Safety

- Do not use any contact spray for cleaning.
- Clean product housings and soiled contacts with propanol.
- The products are not resistant to materials having seeping and insulating properties such as aerosols, silicones and triglycerides (found in some hand creams). If these substances occur in the environment of the products, install the products in an additional housing that is also resistant to these substances.
- Replace any defective or damaged devices.
- Do not place products on the data or power jumper contacts.
- If product fails, communication to downstream products may be interrupted.
- Products from the WAGO I/O System 750/753 can be operated in combination with those of the WAGO I/O System 750 XTR. Such mixed operation does not change the maximum permissible ambient conditions of the individual products.
- Operate ETHERNET and PROFINET interfaces in separate networks.
- Observe possible different technical specifications for mounting that does not correspond to the specified mounting position.
- Only use accessories authorized by WAGO.

System Features

3.1 Component Structure

3.1.1 Component Designs

There are different housing forms in the WAGO I/O System 750.

Head Stations

The housings of head stations (fieldbus couplers or controllers) differ in:

- The connection level
 - The power supply on the field level
 - No power supply on the field level (Eco)
- The operator control elements and indicators
- The respective fieldbus interfaces
- Further communication interfaces

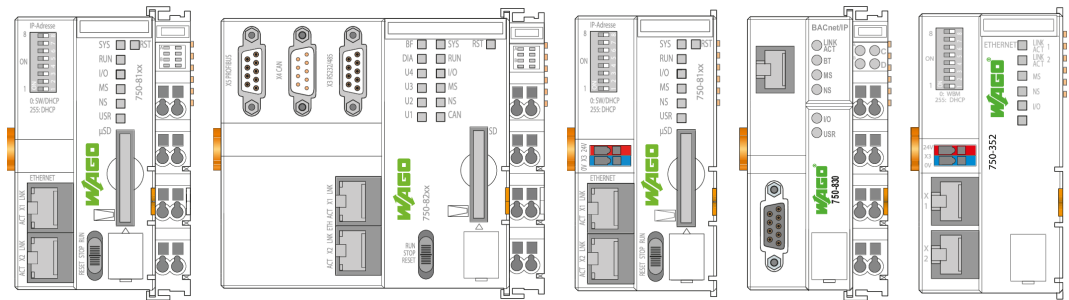

Figure 1: Example housing of the head stations

I/O Modules

The housings of the I/O modules differ in:

- The module width
 - Single width (12 mm)
 - Double width (24 mm)
 - Quadruple width (48 mm)
- The structure of the wiring interface
- Different display elements
- Fuse holder

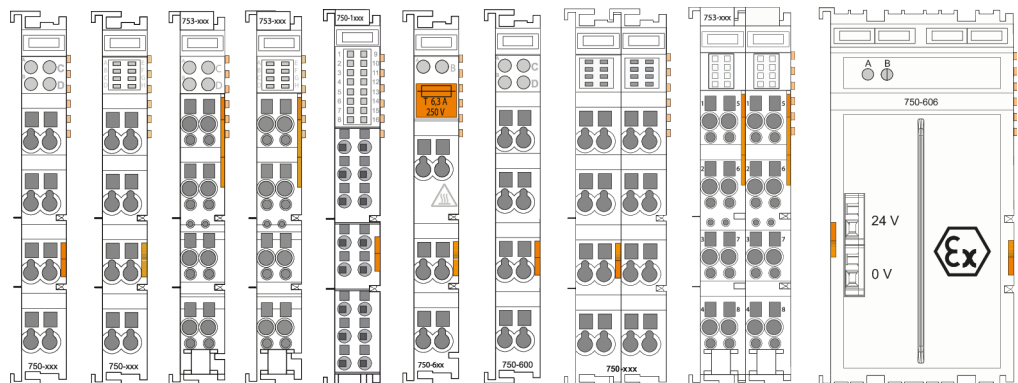

Figure 2: Example housing of the I/O modules

3.1.2 Structure of the Head Stations

Example PFC View

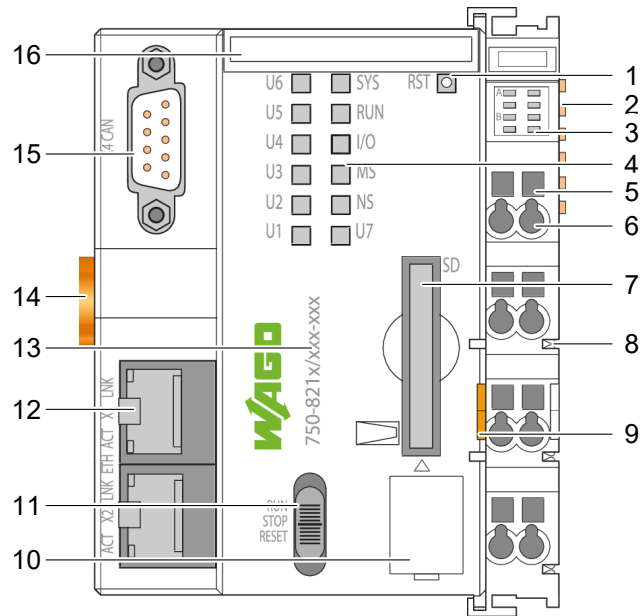

Figure 3: Example PFC View

1	Reset button	Product Manual
2	Data contacts	System Contacts [▶ 20]
3	Display elements: Power supply status	Product Manual
4	Display elements: System status	Product Manual
5	Access to open the associated CAGE CLAMP® connection	Conductor Termination [▶ 51]
6	CAGE CLAMP® connection for the power supply connection	
7	Memory card slot with protective flap	Product Manual
8	Power jumper contact (spring)	System Contacts [▶ 20]
9	Release tab	Assembly and Disassembly [▶ 44]
10	Service interface cover	
11	Mode selector switch	Product Manual
12	Network connection	Product Manual
13	Item number	Product Identification [▶ 17]
14	DIN-rail locking cam	Assembly and Disassembly [▶ 44]
15	Serial interface (optional)	Product Manual
16	Slot for Mini-WSB (optional)	

Example View of the Fieldbus Coupler/Controller

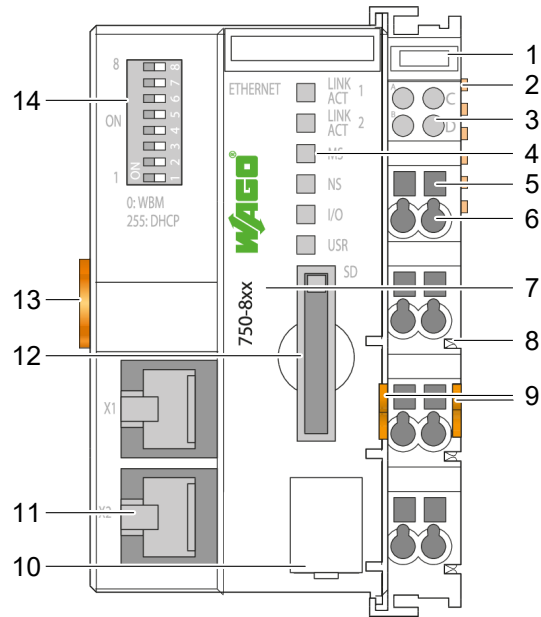

Figure 4: Example View of the Controller

1	Slot for Mini-WSB (optional)	
2	Data contacts	System Contacts [▶ 20]
3	Display elements: Power supply status	Product Manual
4	Display elements: Fieldbus status	Product Manual
5	Access to open the associated CAGE CLAMP® connection	Conductor Termination [▶ 51]
6	CAGE CLAMP® connection for the power supply connection	
7	Item number	Product Identification [▶ 17]
8	Power jumper contact (spring)	System Contacts [▶ 20]
9	Release tab	Assembly and Disassembly [▶ 44]
10	Service interface cover	
11	Fieldbus connection (optional)	Product Manual
12	Memory card slot with protective flap	Product Manual
13	DIN-rail locking cam	Assembly and Disassembly [▶ 44]
14	Address selection switch (optional)	Product Manual

3.1.3 I/O Module Configuration

Example View of the I/O Module 750 Series (CAGE CLAMP® Connections)

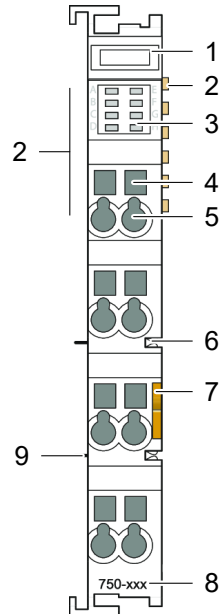

Figure 5: I/O module 750 Series with CAGE CLAMP® connections (example)

1	Slot for WSB (optional)	
2	Data contacts	System Contacts [▶ 20]
3	Indicators	Product Manual
4	Access to open the associated CAGE CLAMP® connection	Conductor Termination [▶ 51]
5	CAGE CLAMP® connection	
6	Power jumper contact (spring)	System Contacts [▶ 20]
7	Release tab	Assembly and Disassembly [▶ 44]
8	Item number	Product Identification [▶ 17]
9	Power jumper contact (blade)	System Contacts [▶ 20]

Example View of the I/O Module 750 Series (Push-in CAGE CLAMP® Connections)

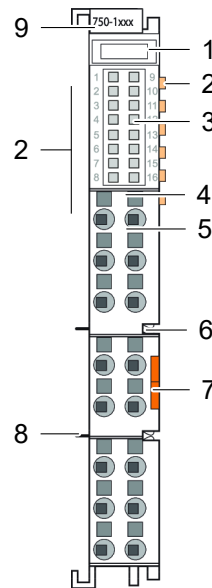

Figure 6: I/O module 750 Series with Push-in CAGE CLAMP® connections (example)

1	Slot for WSB (optional)	
2	Data contacts	System Contacts [▶ 20]
3	Indicators	Product Manual
4	Access to open the associated Push-in CAGE CLAMP® connection	Conductor Termination [▶ 51]
5	Push-in CAGE CLAMP® connection	
6	Power jumper contact (spring)	System Contacts [▶ 20]
7	Release tab	Assembly and Disassembly [▶ 44]
8	Power jumper contact (blade)	System Contacts [▶ 20]
9	Item number	Product Identification [▶ 17]

Example View of the I/O Module 753 Series (Pluggable Connector)

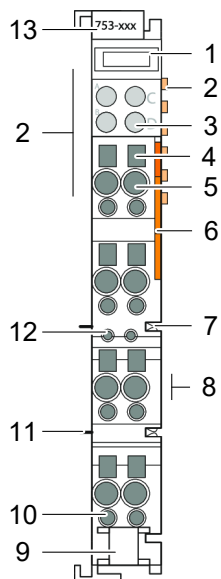

Figure 7: I/O module 753 Series (example)

1	Slot for WSB (optional)	
2	Data contacts	System Contacts [▶ 20]
3	Indicators	Product Manual
4	Access to open the associated CAGE CLAMP® connection	Conductor Termination [▶ 51]
5	CAGE CLAMP® connection	
6	Unlocking tab for the pluggable connector	Assembly and Disassembly [▶ 44]
7	Power jumper contact (spring)	System Contacts [▶ 20]
8	Release tab for the I/O module	Assembly and Disassembly [▶ 44]
9	Fastening tab for cable ties	
10	Test slot for associated CAGE CLAMP® connection	
11	Power jumper contact (blade)	System Contacts [▶ 20]
12	Coding Key	Assembly and Disassembly [▶ 44]
13	Item number	Product Identification [▶ 17]

3.1.4 Product Identification

3.1.4.1 Versions

Color Coding for Identifying the Component Type

To get an overview of the different I/O components quickly and easily, they are color-coded.

Table 1: Color coding of Component Types

Housing Color	Component Type
Light gray	WAGO I/O System 750 (standard modules)
Blue	Intrinsically safe modules (Ex i)
Signal yellow	Modules for functional safety
Blue + signal yellow	Intrinsically safe modules (Ex i) for functional safety
Dark gray	WAGO I/O System 750 XTR
Blue + dark gray	WAGO I/O System 750 XTR – intrinsically safe modules (Ex i)

Color Coding for Identifying Functionality

To quickly and easily get an overview of the component classes present in a node, they are color-coded. The color coding is implemented as follows:

- Housings with up to 4 round display elements have permanently built-in, color-coded, pull-out labeling fields.
- Housings with 8 display elements can be color-coded by attaching labeling elements (Mini-WSB) over the display elements.
- For housings with 16 display elements, they are highlighted in color.

Table 2: Color coding of component classes

Color of the Coding Key	Component Class
Green	Analog Inputs
Blue	Analog Outputs
Yellow	Digital Inputs
Red	Digital Outputs
Transparent	Supply Modules, Function and Technology Modules

3.1.4.2 Marking Example

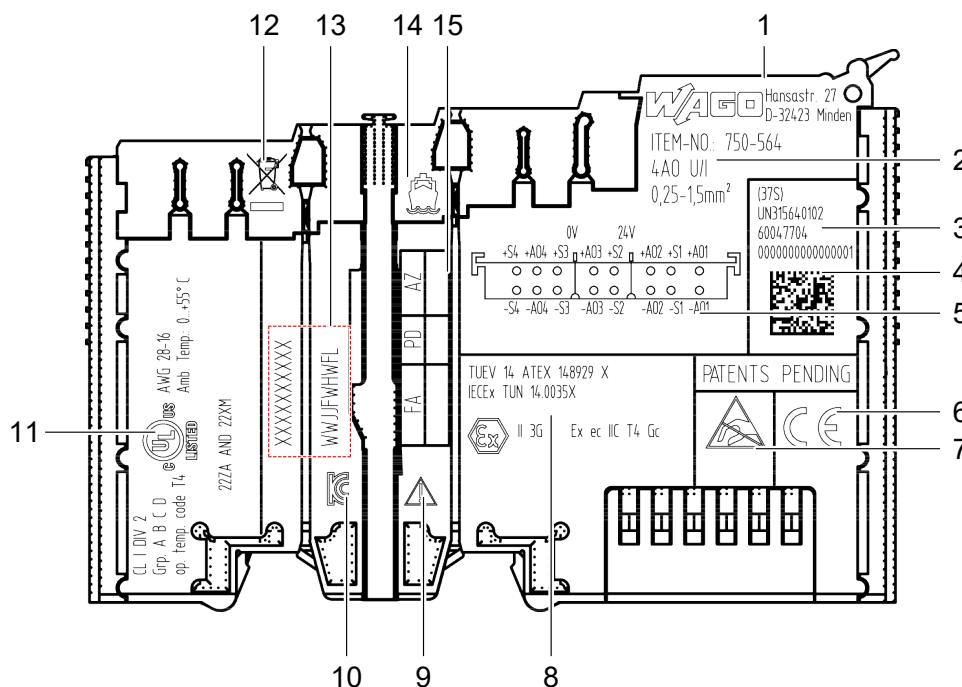









Table 3: Explanation of the Marking Example

No.	Contents	Description
1	 WAGO Logo and Address Hansastr. 27 D-32423 Minden	WAGO GmbH & Co. KG
2	Product information	Item number and product description; conductor cross section where required
3	(37S) UN315640102 60047704 0000000000000001	Production data
4		DataMatrix code
5	Terminal allocation	More information on the topic of Connections in the respective  Product Manual .
6	 CE mark	The CE mark indicates WAGO has declared that the product conforms with the applicable requirements as set out in Community harmonization legislation per EC Regulation 765/2008, which allows the product to carry this mark.
7	 "ESD" exclamation icon	Note: Avoid electrostatic discharge! The products are equipped with electronic components that may be destroyed by electrostatic discharge when touched. Please observe the safety precautions against electrostatic discharge per DIN EN 61340-5-1/-3.
8	 "Ex" registration icon	The product meets the classified requirements according to ATEX for operation in potentially explosive areas. More information on the topic of Approvals in the respective  Product Manual .















No.	Contents	Description
9	 "Notice" exclamation icon	Note: Observe the product documentation! There is applicable information and documents about the product that must be observed.
10	 "KC" registration icon	This approval mark stands for compliance with the Korean product safety requirements for electrical and electronic devices and components.
11	 "cULus" registration icon	Certified safety mark of UL listed products for the American and Canadian market.
12	 "WEEE" mark	Note: Electrical and electronic equipment must not be disposed of with household waste! Electrical and electronic equipment contain materials and substances that can be harmful to the environment and health. Electrical and electronic equipment must be disposed of properly after use. More information on this topic: 🔗 Disposal and Recycling [▶ 52] .
13	Serial number:	🔗 Identification [▶ 20]
14	 "Marine Approvals" icon	Collective icon for marine approvals. More information on this topic: 🔗 Special Applications and Environments [▶ 34] . More information on the topic of Approvals in the respective 📖 Product Manual .
15	Update matrix	🔗 Update Matrix [▶ 20]

Table 4: Explanation of the Different Marking Example

No.	Contents	Description
	 "RFID" icon	This product contains RFID (Radio Frequency Identification) technology.
	 "Hot surface" alert icon	Warning: Do not touch hot surfaces! The housing surface can become hot during operation. If the product has been used in high ambient temperatures, let it cool down before touching it.
	 "TÜV" registration icon	TÜV (Technischer Überwachungsverein) Rheinland® as a testing laboratory for functional safety.
	 "FS" registration icon	Conformity marks with the keyword "Functional safety" are issued for electrical / electronic / programmable electronic and electromechanical products that are intended for use in safety-related applications. A type test for these products has shown that they are sufficiently safe and reliable according to a defined safety level and are suitable for use in safety functions to protect people, the environment and valuable goods.
	 "RCM" mark	With the RCM marking (Regulatory Compliance Mark), WAGO declares in accordance with Australian standards that the product meets the applicable requirements.
	 "CCC" mark	With the CCC marking (China Compulsory Certification), WAGO declares in accordance with the standards applicable to the Chinese market that the product meets the applicable requirements.

No.	Contents	Description
		"EAC" icon The EAC mark indicates that the product conforms to the safety requirements set forth in the EEU technical requirements.
		"EAC Ex" icon The EAC Ex mark indicates that the product conforms to the safety requirements set forth in the EEU technical requirements for operation in hazardous areas.
		"UR" registration icon Certified safety mark from UL recognized components for the American and Canadian market.

3.1.4.3 Identification

The production number contains internal production data as well as product-specific production data. The production number can be:

- One row: XXXXXXXXXXXX_WWYYFHWFL
- Two row: XXXXXXXXXXXX
WWYYFHWFL

Table 5: Production number

XXXXXXXXXX	Production item number, 10-digit
WWYYFHWFL	WW: Production week YY: Production year FW: Firmware index HW: Hardware index FL: Firmware loader index

3.1.4.4 Update Matrix

In the case of a factory update, the updated production data is documented in the update matrix. The initial manufacturing information on the product housing remains unchanged. In the case of a head station, the cover flap of the service interface is also printed with the updated production number.

Table 6: Update Matrix

FA	XXXXXXXXXX	Production item number, 10-digit
PD	WWYY	WW: Production week YY: Production year
AZ	FHWFL	FW: Firmware index HW: Hardware index FL: Firmware loader index

3.1.5 System Contacts

3.1.5.1 Data Contacts

Components and the I/O module power supply communicate via the data contacts.

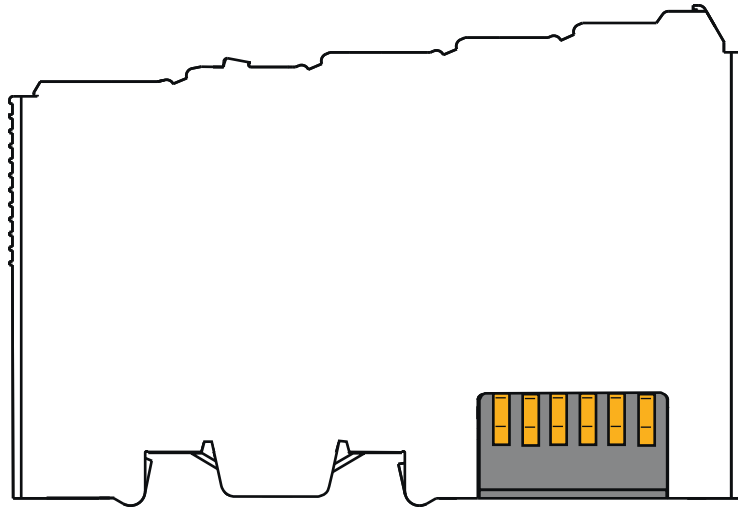

Figure 8: Data Contacts

3.1.5.2 Power Jumper Contacts

The field power supply is distributed in the I/O system via the power jumper contacts. The contacts on the left side are male contacts; those on the right side are touch-proof spring contacts.

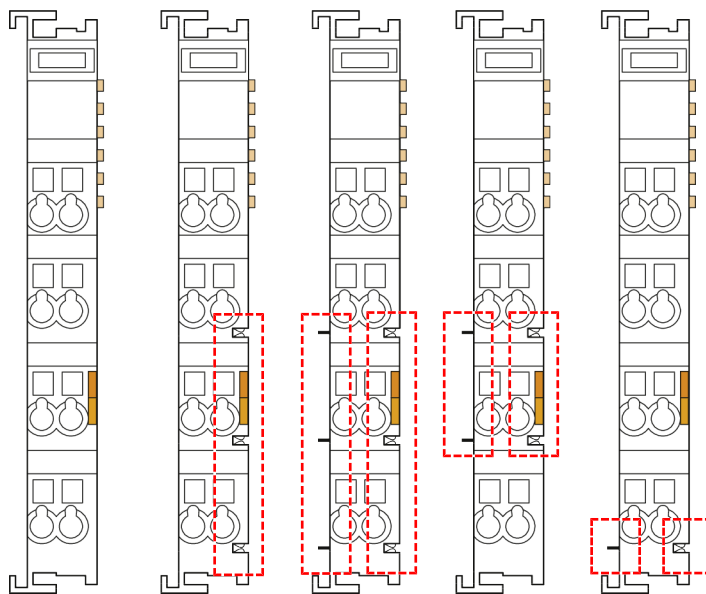

Figure 9: Example: Power Jumper Contact Arrangement (left: male contacts; right: spring contacts)

3.1.5.3 DIN-Rail Contact

Many components of the I/O system transmit electromagnetic interference to the DIN-rail via DIN-rail contacts. The DIN-rail contacts of the modules are automatically connected when they are snapped on to the DIN-rail.

For the I/O modules, there is usually no direct connection between the DIN-rail contact and the ground connections of the wiring interface and the associated power jumper contacts. The specific design is described in [Product Manual](#).

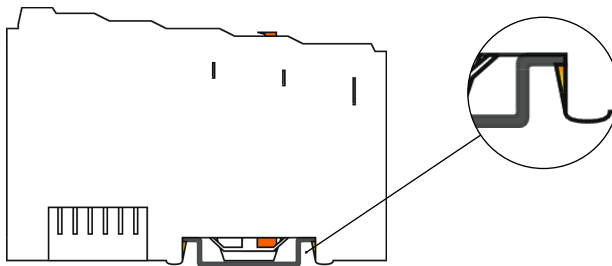

Figure 10: DIN-Rail Contact (example)

3.1.6 Coding Keys

I/O modules of the 753 Series and the associated plug-in wiring interfaces can have coding keys to prevent incorrect insertion. The coding using small plastic pins and sockets simplifies assignment of the wiring interface to the I/O module.

More information about this topic: [🔗 Inserting Coding Keys ▶ 49](#)

3.1.7 Marking Elements

The system components can be provided with labeling elements:

- On head stations:
 - Above the indicators
 - If there is a power supply infeed, above the individual connections
- On I/O modules of the 750 and 753 Series:
 - Above the indicators
- On some I/O modules of the 750 Series:
 - Above the individual connections

3.2 Electrical Structure

3.2.1 Potential Groups

The I/O system is divided into the following potential groups.

- **System Level**

This potential group encompasses all the system-side electronics and among other things, includes the system supply and the local bus signals.
- **Field Level**

This potential group contains the field-side power supply and I/O signals. The node structure can be divided into different sections through the supply and segment modules. Different field potentials can be used in the individual sections.
- **Fieldbus**

This potential group contains the signals of the respective fieldbus interface. The voltage and current levels depend on the fieldbus standard used.
- **Functional Ground**

To discharge EMC interference, the system power supply, the field power supply and the I/O signal inputs and outputs are capacitively coupled within the module to the functional ground via the DIN-rail contacts.

Example Potential Groups / Separation with Galvanically Separated Power Supply Infeed

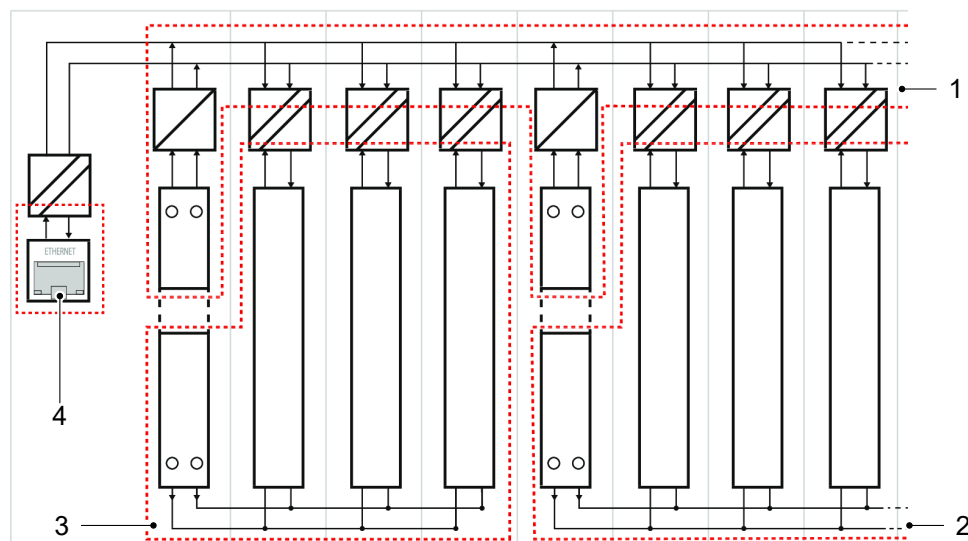

Figure 11: Display of Different Potential Groups

1	System-level potential groups
2	Field-level potential groups in right node section
3	Field-level potential groups in left node section
4	Fieldbus system potential groups

3.2.2 System Supply

The system is supplied through the fieldbus coupler/controller and where needed, through additional supply modules with bus power supplies. The system-side component electronics are protected against reverse polarity.

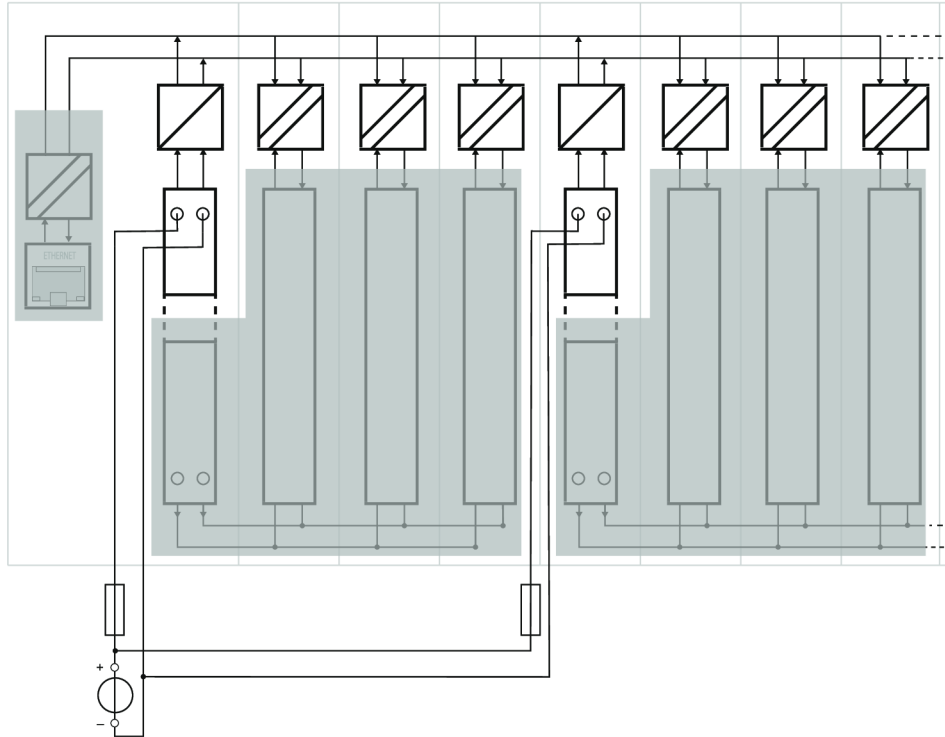



Figure 12: System Supply Input (example)

Observe the following system supply requirements:

- Use voltage sources with safe extra-low voltage (SELV, PELV).
- Power **must** be supplied simultaneously to **all** system supply inputs.
WAGO recommends using the same voltage source to realize the power supply.
- Be sure maximum permissible current values are not exceeded.
- Use an external fuse to protect the system supply of each power supply.

Product-specific information is available from the technical data in the respective  **Product Manual**.

3.2.3 Field Supply

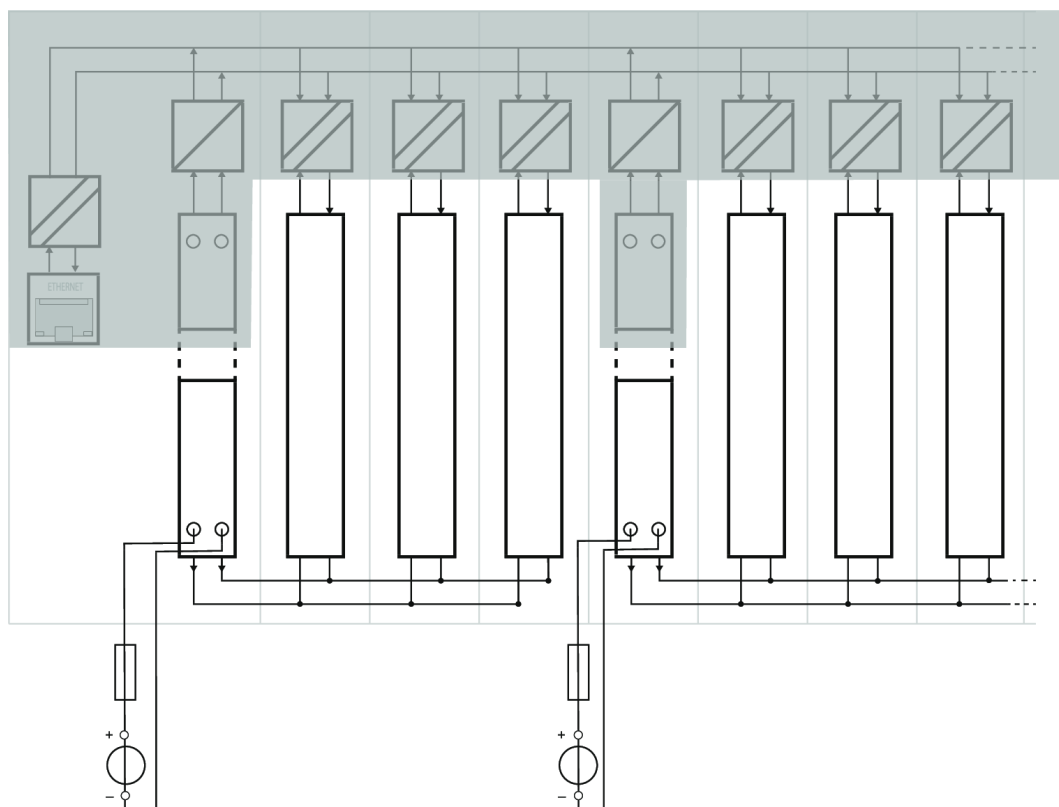

Figure 13: Field Supply Input (example)

Observe the following requirements for the field supply:

- Use voltage sources with safe extra-low voltage (SELV, PELV) for all voltages with a nominal value of 24 VDC.
- Be sure to include an overcurrent protection device to ensure the maximum permissible current values are not exceeded.

Additional supply modules are needed for:

- Higher power requirements
- Use of different potential groups
- Use of different field voltages
- Functional change (e.g., Ex i or functional safety)

3.2.4 Power Supply Components

The following components are needed to establish a power supply:

- **Voltage Sources with Safe Extra-Low Voltage (SELV, PELV)**
- **Overcurrent protection devices**
 - Supply modules with integrated fuses
 - External fuse terminal blocks
 - Circuit-breakers
- **Suitable isolation devices**, e.g., non-automatic circuit-breaker
- **Supply modules**
 - Bus power supplies
 - Supply module

Depending on the application area, the following may also be needed:

- **Filter modules**
- **Distance modules**

The distance modules are used to realize the increased requirements for clearances and creepage distances.



- **Voltage buffers**
 - UPS modules
 - Capacitive buffer modules

Functions

4.1 Process Image

After switching on, the head station identifies the inserted I/O modules that send or expect to receive data (data width > 0). The head station creates an internal local process image from the data width, the module type and the position of the I/O module in the node. This process image is divided into input and output data zones.

The head station provides one or more external process images that are used, for example, for data transmission via a fieldbus. The structure of an external process image depends on:

- The selection and arrangement of the I/O modules in the node. Some I/O modules allow you to configure the arrangement and amount of the data they provide. Information on the process data provided by an I/O module is available in the  **Product Manual** of the I/O module.
- The properties of the external interface (e.g., of the fieldbus) and the properties of the head station. More information is available in the  **Product Manual** of the head station. Examples of process image properties that can differ between head stations:
 - Arrangement of the process data in the order of the physical placement of the I/O modules
 - Grouping of the process data so that analog field signals come before digital field signals
 - Insertion of filler bits or bytes so that data of an I/O module starts on a word boundary
 - Hiding of diagnostic bits from the process data of the I/O modules and/or map them to fieldbus-specific diagnostic mechanisms
 - Adaptation of the endianness to the properties of the fieldbus
 - Limiting of the amount of data to packet sizes that can be processed by the fieldbus

Planning

5.1 Node Structure

Note that product-specific configuration or test steps may be necessary. For example before:

- Commissioning
- Recommissioning
- Exchange and replacement of I/O modules

These configuration or test steps are described in the respective  **Product Manual**.

Types of Components

Several different types of components are used in the I/O system:

- **Head Stations:**
 - PFC
 - Controller
 - Fieldbus couplers
- **I/O Modules:**
 - Analog input and output modules
 - Digital input and output modules
 - Function and technology modules
 - Communication modules
 - Supply and segment modules

Number of I/O Modules

The maximum number of I/O modules that can be operated in one node depends on several factors:

- **Mechanical Expansion:**

The distance between a head station and an end module must not exceed 768 mm, including the end module. If a node is wider, it must be divided into several sections with an additional fieldbus coupler, controller or internal data bus extension.
- **Addressability:**

Depending on the head station used, a maximum of 250 I/O modules can be addressed.

I/O modules that do not have any process or diagnostic data (e.g., distance modules) do not need to be taken into account when calculating the number.
- **Head Station Memory:**

Head stations have a limited memory for the process image.
- **Fieldbus Technology Characteristics**

5.2 Structure Guidelines

5.2.1 Installation Site and Touch-Proof Protection

The WAGO I/O-System is an open system. As such, it must only be installed within appropriate housings, cabinets or electrical operation rooms that fulfill at least the following requirements:

- Offer adequate protection against direct or indirect contact.

- Offer adequate protection against UV irradiation.
- Restrict access to authorized personnel and may only be opened with tools.
- Ensure the required pollution degree in the vicinity of the system.
- Prevent fire from spreading outside of the enclosure.
- Guarantee mechanical stability.

5.2.2 Overcurrent Protection

System and field supply are through the head station and/or additional supply modules. Protect the power supply as specified in the technical product data. Use:

- Supply modules with integrated fuses
- External fuses

5.2.3 Ground Conductor

The I/O system does not require a protective conductor connection for proper operation. In addition, the I/O system does not provide any protective conductor functionality via the field connections. If a protective conductor connection is required, it must be implemented outside the system.

5.2.4 Buffering

To compensate for power interruptions per IEC 61131 (PS-1 or PS-2), external buffering is required.

Buffer capacity depends on the node configuration, which is why it is not possible to provide general information on the required capacity.

5.2.5 Mounting Position

All specifications and handling steps refer to the nominal mounting position. Deviating mounting positions affect, for example:

- Air circulation
- Measuring accuracy

Maintain the following clearances to adjacent components, cable ducts and the sides of housings and frames for the entire node structure.

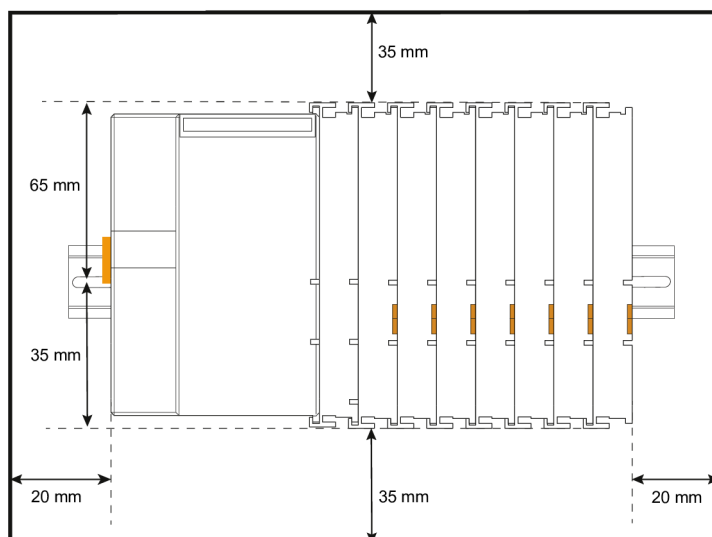

Figure 14: Installation Clearances

Coordinate Model

i Note

Modified Coordinate Model

In product documentation published before 2021, the height (y) and depth (z) have been swapped!

- Width = Dimension along X axis = Horizontal in nominal mounting position; parallel to DIN-rail longitudinal axis
- Height = Dimension along Y axis = Vertical in nominal mounting position
- Depth = Dimension along Z axis = Horizontal in nominal mounting position; perpendicular to DIN-rail longitudinal axis

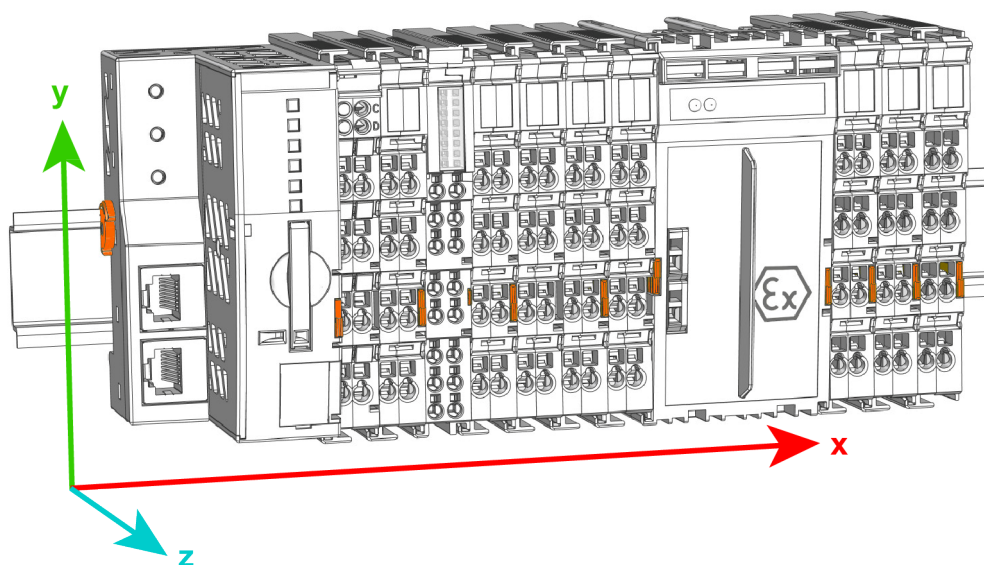
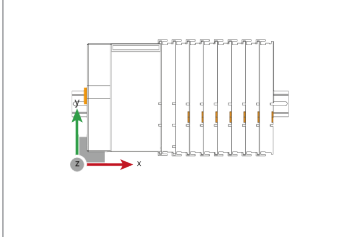
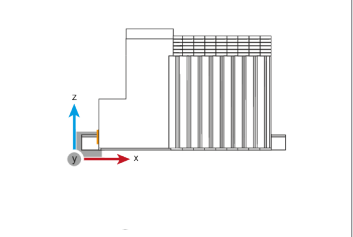
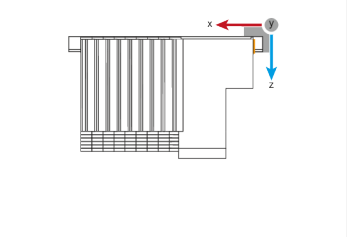
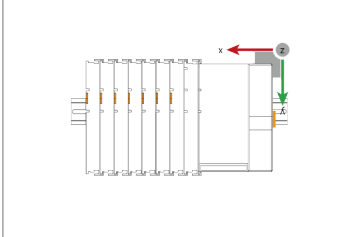
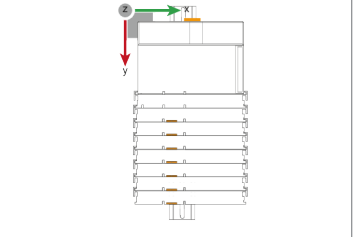
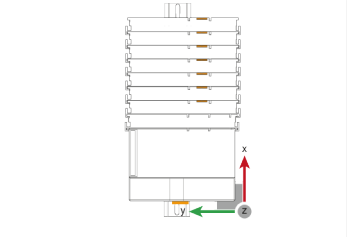

Figure 15: Coordinate model: width (x), height (y), depth (z)

Overview of Mounting Positions

		
Nominal mounting position (horizontal left)	Floor mounting position	Ceiling mounting position
		
Mounting position, horizontal right	Mounting position, vertical top	Mounting position, vertical bottom
For vertical installation, always mount an end stop below the node to prevent it from slipping off.		

5.2.6 DIN-Rail Characteristics

To ensure optimum system construction, all system components can be securely snapped onto a DIN-rail (35 mm). Observe:

- The material must have high corrosion resistance.
- The DIN-rail geometry must not be altered.
- Prevent bending and twisting (torsion) e.g., by using sufficient attachment points.
- Use countersink-head screws, blind rivets, etc., to countersink the attachment points beneath the node structure.
- The component DIN-rail contact (CuSn6) must not form a galvanic element with the DIN-rail that is capable of generating a differential voltage of more than 0.5 V (saline solution of 0.3% at 20°C/68°F).

5.2.7 EMC Installations

- **Use filter modules longer than 30 m for 24V power supplies.**

To comply with EN 61000-6-2:2019, filter modules (750-626/xxx-xxx or 750-624/xxx-xxx) must be used for power supplies for the system and field supply that are longer than 30 m.

- **Ground DIN-rails.**

Ground the DIN-rails to divert electromagnetic interference.

- **Use shielded cables for data and signal lines.**

Electromagnetic interference is reduced and signal quality increased. Measurement errors, data transmission faults and interference due to excessive voltage can be prevented!

- **Keep data and signal lines separate from interference sources.**

Route data and signal lines separately from all power supply cables and other sources of high electromagnetic emissions (e.g., frequency converters or drives).

- **Connect the cable shielding with the ground potential.**
Integrated shielding is mandatory to meet technical specifications regarding measurement accuracy. Establish the connection between the cable shielding and ground potential at the inlet of the cabinet or housing. This grounding allows induced interferences to dissipate and be kept away from devices in the cabinet or housing.
- **Improve shielding performance with a large contact area.**
Greater shielding performance is achieved via low-impedance connection between shielding and ground. For this purpose, connect the shielding over a large surface area, e.g., using the WAGO 790 Shield Connection System. This is especially recommended for large-scale systems where equalizing or high impulse currents may occur.

5.2.8 Data Security

Professional planning and design is an important requirement for securing data confidentiality, availability and integrity.

Random Influences

Data transmission and processing can be disrupted by random influences, such as temporary electromagnetic disturbances. Proper setup can significantly reduce the likelihood of corruption or destruction of data.

For additional information see:  [EMC Installations \[p. 31\]](#).

Deliberate Influences

Use in ETHERNET Areas

ETHERNET products are designed for use in local networks. Please note the following when using ETHERNET products in your system:

- Do not connect control components and control networks to an open network such as the Internet or an office network.
WAGO recommends putting control components and control networks behind a fire-wall.
- In the control components, close all ports and services (e.g., for WAGO-I/O-CHECK and CODESYS) not required by your application to minimize the risk of cyber attacks and to enhance cybersecurity.
Only open the ports and services for the duration of the commissioning/configuration.
- Limit physical and electronic access to all automation components to authorized personnel only.
- To reduce the risk of unauthorized access to your system, change the default passwords before initial commissioning.
- To reduce the risk of unauthorized access to your system, regularly change the passwords used.
- To verify that the measures taken meet your security requirements, regularly perform threat analyses.
- To restrict access to and control of individual products and networks, employ a “defense-in-depth” mechanism in your system’s security configuration.

Additional documents

-  [Manual Cybersecurity for PFC100 / PFC200 Controllers](#)

-  [White Paper Cybersecurity in Production Facilities](#)

All the documentation and information is available at:  www.wago.com.

Use of Cloud Services

Note

Please note the risks of using cloud services!

If you use third-party cloud services, sensitive data is transferred to the cloud service provider on your own responsibility. External access may result in manipulated data and/or unwanted control commands affecting the performance of your control system.

- Use encryption methods to protect your data.
- Observe the information provided by the Federal Office for Information Security – “Cloud: Risks and Security Tips.”
- Observe comparable publications of the responsible authorities of your country.

Additional information is available at:  www.bsi.bund.de.

5.3 Designing the System Supply

Designing the system supply requires knowledge of the entire system-side power consumption of the installed I/O modules. If the total system-side power consumption exceeds the maximum permissible total current of the power supply, an additional system supply must be added.

Product-specific information is available from the technical data in the respective  **Product Manual**.

For fast, effortless supply design, use the WAGO Configurator Smart Designer.

A calculation example is available at:  [Examples and Aids \[▶ 40\]](#)

See also

-  [Examples and Aids \[▶ 40\]](#)

5.4 Field Supply Layout

Designing the field supply requires knowledge of the entire field-side power consumption of the installed I/O modules. The field-side power consumption of an I/O module consists of:

- Demand from the field-side I/O module electronics
- Possible output currents of the I/O modules used

Detailed product information is available in the respective  **Product Manual**.

More power must be provided with an additional supply module if the maximum permissible total current:

- Of the power supply is reached and/or
- Of the power jumper contacts is reached.

For fast, effortless supply design, use the WAGO Configurator Smart Designer.

A calculation example is available at: [🔗 Examples and Aids \[► 40\]](#)

5.5 Special Applications and Environments

5.5.1 Marine and Offshore

The node structure must meet additional requirements to qualify for certified marine application.

If these requirements are specific to an I/O module, they are described in the respective  **Product Manual**. Otherwise, the following general requirements for marine applications apply.

A filter module must be used for each system and field supply input point with a nominal voltage of 24 VDC:

- Use a power supply filter (750-626/xxx-xxx) for the system supply.
- Use a field supply filter (750-624/xxx-xxx) or a power supply filter (750-626/xxx-xxx) for the field supply.

No additional filter module is required for the field supply with a nominal value of 230 V.

Marine Applications acc. DNV GL

- Class A: All areas except bridge and open deck
- Class B: All areas including bridge and open deck

Applications with Isolation Monitoring

High-isolation (HI) versions of the filter modules are required for application areas with isolation monitoring.

Table 7: High-Isolation Filter Modules

High-Isolation Filter Modules	
Field-side power supply filters	Filter module, 24 VDC, HI (750-624/020-000)
	Filter module, 24 VDC, HI, no power jumper contacts (750-624/020-001)
	Filter module, 24 VDC, HI, with ground fault diagnostics (750-624/020-002)
Filter module	Filter module, 24 VDC, HI (750-626/020-000)
	Filter module, 24 VDC, HI, with ground fault diagnostics (750-626/020-002)
	Filter module, 24 VDC, HI/T (750-626/025-001)

Example of a Power Supply Concept for Marine Applications - Class A and B per DNV GL

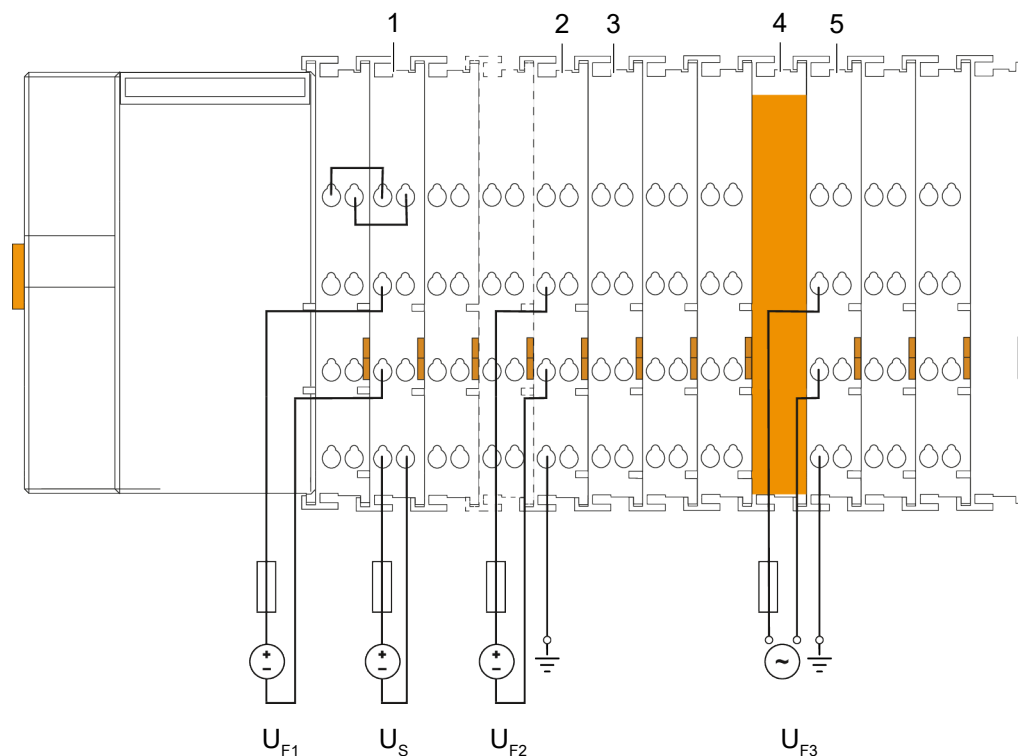

Figure 16: Power Supply Concept for Marine Applications – Class A and B

1	Filter module, 24 VDC, HI GF (750-626/020-002) or filter module, 24 VDC, HI (750-626/020-000) or filter module, 24 VDC, HI / T (750-626/025-001)
2	Bus supply module, 24 VDC (750-602) or bus supply module, 24 VDC, with fuse (750-601) or bus supply module, 24 VDC, with fuse and diagnostics (750-610)
3	Filter module, 24 VDC, HI GF 750-624/020-002 or filter module, 24 VDC, HI 750-624/020-000
4	Distance module, 24 VDC / 230 VAC (750-616/030-000)
5	Bus supply module, 230 VAC/DC, with diagnostics, with fuse holder (750-611) or bus supply module, 230 VAC/DC, without diagnostics, with fuse holder (750-609) or bus supply module, 230 VAC/DC, without diagnostics, without fuse holder (750-612)
U_S	System supply (24 VDC)
U_{F1}	Field supply 1 (24 VDC)
U_{F2}	Field supply 2 (24 VDC)
U_{F3}	Field supply 3 (230 VAC)

Power Supply with FE Power Jumper Contact

If an FE power contact is required after the filter module (750-626/xxx-xxx), an additional supply module is required after the filter module. To do this, the field supply from the filter module (750-626/xxx-xxx) must be bridged to the supply module.

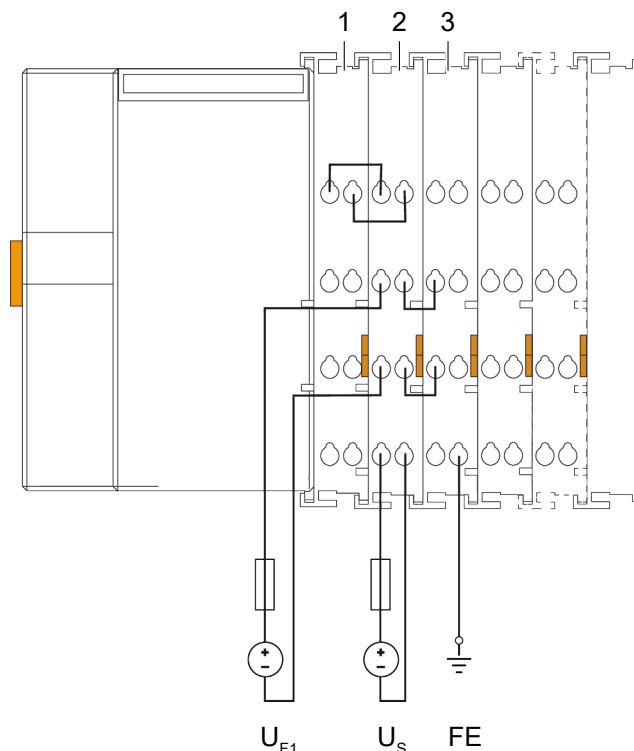

Figure 17: Power Supply Concept for Marine Applications – Class A and B with FE Power Jumper Contact

1	Head station
2	Filter module, 24 VDC, HI GF (750-626/020-002) or filter module, 24 VDC, HI (750-626/020-000) or filter module, 24 VDC, HI / T (750-626/025-001)
3	Bus supply module, 24 VDC (750-602) or bus supply module, 24 VDC, with fuse (750-601) or bus supply module, 24 VDC, with fuse and diagnostics (750-610)
U_S	System supply (24 VDC)
U_{F1}	Field supply 1 (24 VDC)
FE	Functional ground

5.5.2 Ex i Applications

Some I/O modules are intended to be connected with devices located in hazardous areas. To ensure safety and reliability in these applications, several additional requirements must be considered:

- The node structure meets the additional requirements specified below for the power supply as well as the requirements for air and creepage distances.
- The operator obtains a prototype test certificate that confirms the correct installation of the system and store it in a control cabinet or housing.

Observe the detailed requirements as stated in the original wording of the respective certificate ([🔒 Installation Regulations Specified by Approvals ▶ 53](#)).

Power Supply Requirements

Only Ex i bus supply modules are permitted to be used for power supply to any node sections containing I/O modules for Ex i applications.

The following Ex i potential supply modules may be used for this purpose: 750-606, 750-625/000-001.

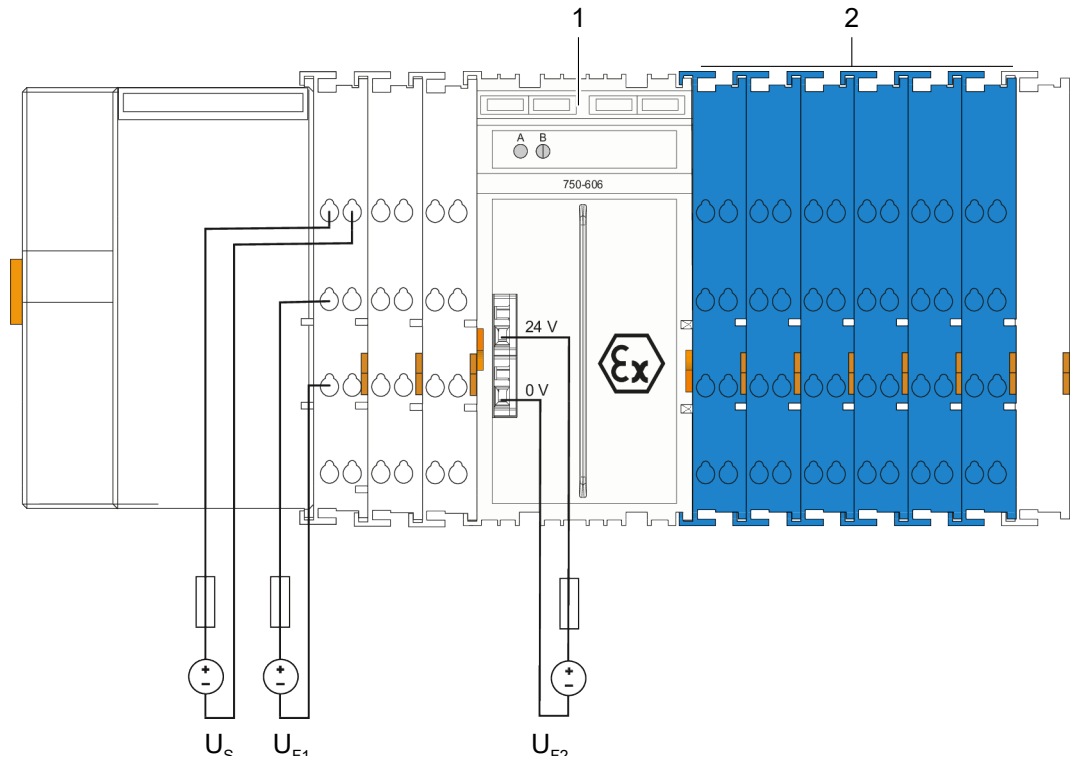

Figure 18: Ex i Power Supply Concept

1	Ex i bus supply module (750-606, 750-625/000-001)*
2	Ex i I/O modules
U_s	System supply (24 VDC)
U_{F1}	Field supply 1 (24 VDC)
U_{F2}	Field supply 2 (24 VDC)

*)
 750-606 with electronic fuse and diagnostics
 750-625/000-001 with electronic fuse and no diagnostics

Clearance and Creepage Distance Requirements

For all sections of a node that contain I/O modules for Ex i use, stricter requirements regarding clearances and creepage distances apply. Before the first such node section, the respective **Ex i supply module** (750-606 or 750-625/000-001) ensures the required distance.

After each such node section, **four distance modules** (750-616) must be used. This also applies when the next section also starts with an **Ex i supply module** (750-606 or 750-625/000-001).

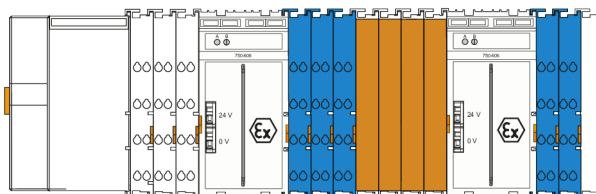

Exceptions:

If the following section consists of an **end module for bus extension** (750-627), **one distance module** (750-616) is sufficient.

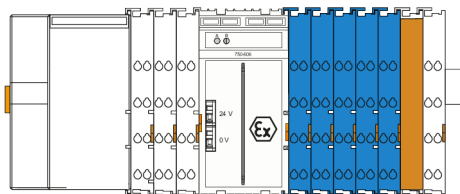

If the following section consists of one **end module** (750-600), no distance modules are required.

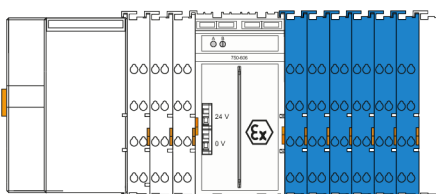

5.5.3 Marine and Offshore Ex i Applications

When I/O modules are used in marine Ex i applications, additional requirements must be considered alongside those described under [Ex i Applications \[▶ 36\]](#) Ex i.

Power Supply Concept for Marine Applications in Ex i Zone, Class A

To use intrinsically safe modules Class A marine applications (all areas, except bridge and open deck), the filter module 750-624/xxx-xxx must be used in conjunction with the Ex i supply module.

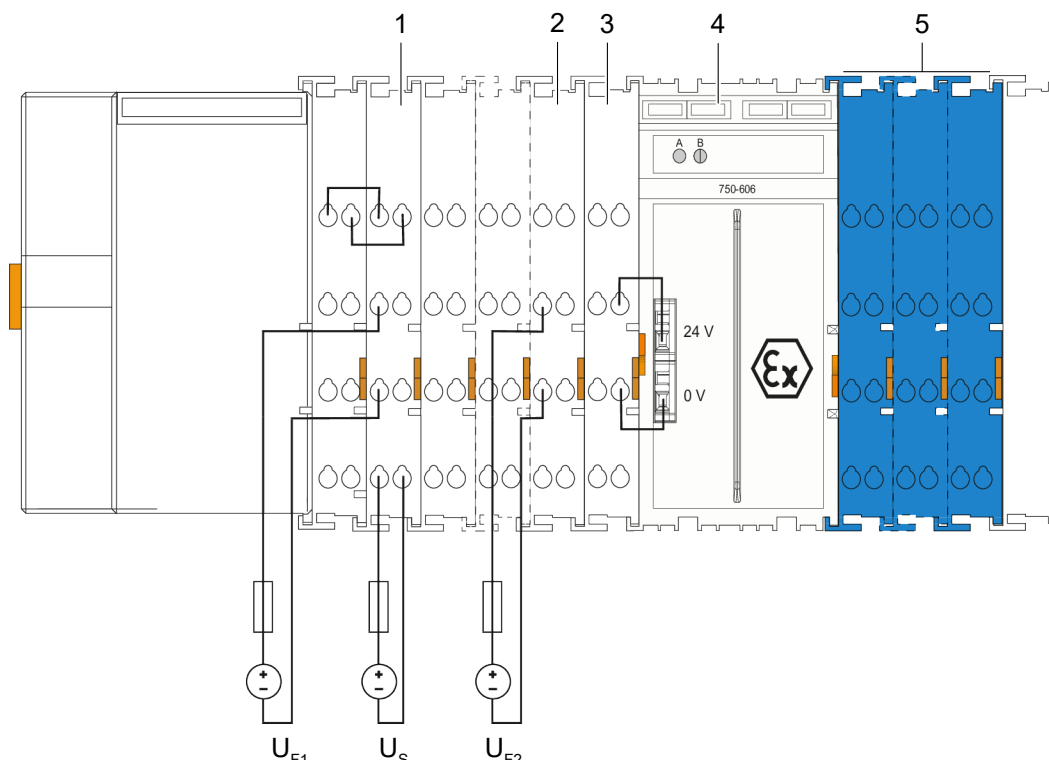

Figure 19: Power Supply Concept for Marine Applications in Ex i Zone – Class A

1	Filter module, 24 VDC, HI GF (750-626/020-002) or filter module, 24 VDC, HI (750-626/020-000)
---	---

2	Bus supply module, 24 VDC (750-602) or bus supply module, 24 VDC, with fuse (750-601) or bus supply module, 24 VDC, with fuse and diagnostics (750-610)
3	Filter module, 24 VDC, HI GF (750-624/020-002) or filter module, 24 VDC, HI (750-624/020-000)
4	Bus supply module, 24 VDC, Ex i, with diagnostics (750-606) or bus supply module, 24 VDC, Ex i (750-625/000-001)
5	Ex i I/O modules

Power Supply Concept for Marine Applications in Ex i Zone, Class B

To use intrinsically safe modules Class B marine applications (all areas, except bridge and open deck), the filter module 750-626/xxx-xxx must be used in conjunction with the Ex i supply module.

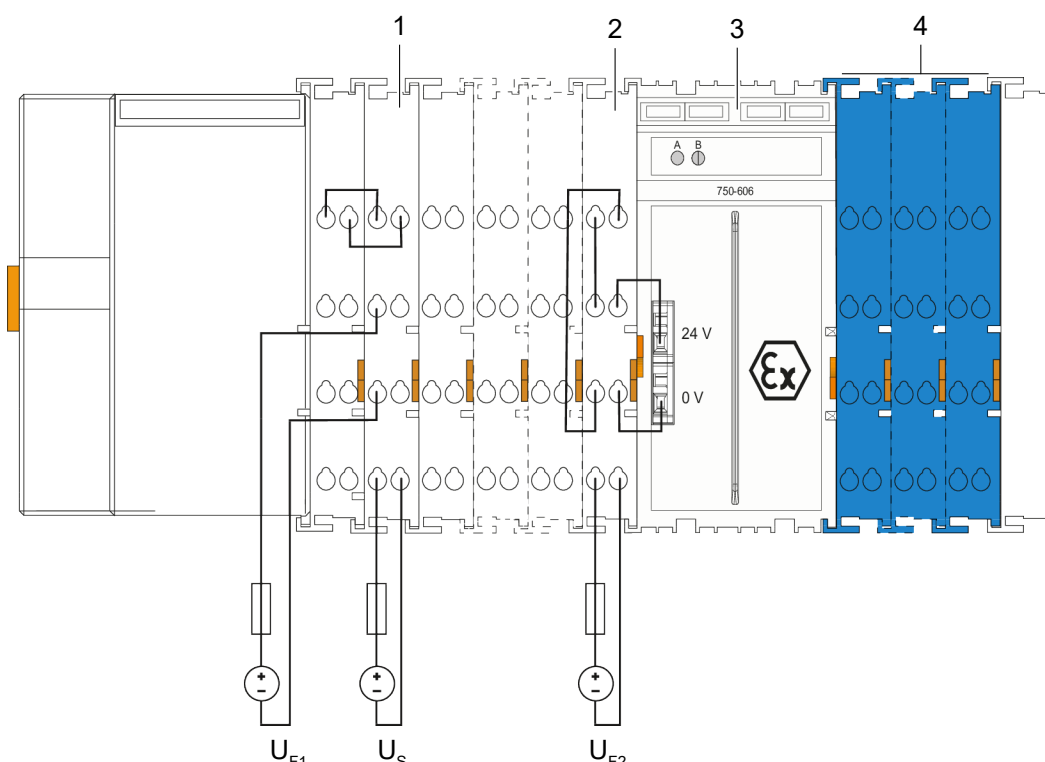

Figure 20: Power Supply Concept for Marine Applications in Ex i Zone – Class B

1	Filter module, 24 VDC, HI GF (750-626/020-002) or filter module, 24 VDC, HI (750-626/020-000)
2	Filter module, 24 VDC, HI GF (750-626/020-002) or filter module, 24 VDC, HI (750-626/020-000)
3	Bus supply module, 24 VDC, Ex i, with diagnostics (750-606) or bus supply module, 24 VDC, Ex i (750-625/000-001)
4	Ex i I/O modules

5.5.4 Functional Safety

5.5.4.1 Power Supply Concept

When using F I/O modules, the system and field supply must be protected against surge voltages (burst and surge) in accordance with EN 61326-3-1.

A filter module must be used for each system and field supply input point with a nominal voltage of 24 VDC:

- Use a power supply filter (750-626/xxx-xxx) for the system supply.
- Use a field supply filter (750-624/xxx-xxx) or a power supply filter (750-626/xxx-xxx) for the field supply.

If these requirements are specific to an I/O module, they are described in the respective  **Product Manual**. Otherwise, the following general requirements apply.

Power Supply Concept Example

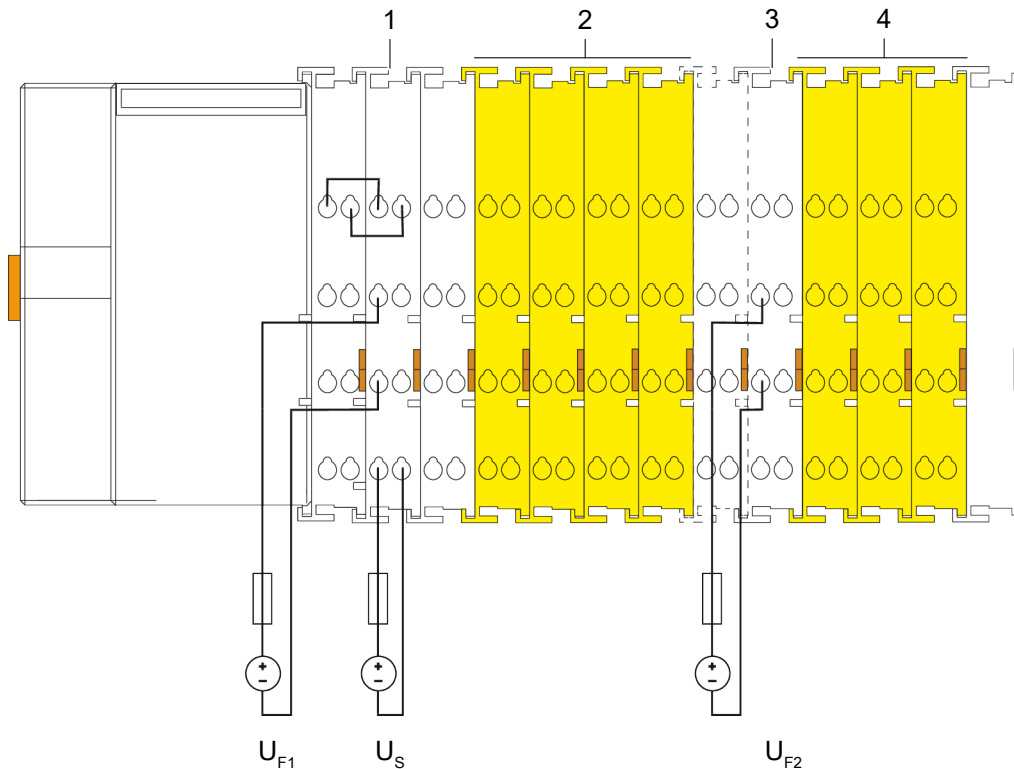

Figure 21: Power Supply Concept Example with F I/O-Modules

1	Filter module, 24 VDC, (750-626/xxx-xxx)
2	F I/O modules
3	Filter module, 24 VDC, (750-624/000-001)
4	F I/O modules
U_S	System supply (24 VDC)
U_{F1}	Field supply 1 (24 VDC)
U_{F2}	Field supply 2 (24 VDC)

5.6 Examples and Aids

5.6.1 Aids

WAGO can help you with a wide range of useful products and software solutions. The aids for project planning include:

- **e!COCKPIT**

e!COCKPIT is an integrated development environment that supports every automation task, from hardware configuration and programming, to simulation and visualization, to commissioning – an all-in-one software package.

- **WAGO Smart Designer** Product Configurator
The **Smart Designer** product configurator enables true 3D configuration of WAGO's electrical interconnect and automation components, including the WAGO-I/O-SYSTEM 750, circuit boards and terminal blocks. With this tool you can, among other things, configure a node of the I/O system and calculate the approximate power requirement.
- **WAGO-I/O-CHECK**
Application for operating and displaying a node from the WAGO 750 I/O-SYSTEM

Coding

Multi-part I/O modules from the WAGO I/O-System can be equipped with coding keys to prevent mismatching when connecting the individual module parts.

For additional information see:  [Assembling/Disassembling Components \[► 49\]](#).

System Supply Power Requirement: Example Calculation

The example calculation is based on the following node structure:

- Head station
- 5 × 16-channel digital input module
- 5 × 16-channel digital output module
- 11 × 8-channel analog input module
- 10 × 8-channel analog output module
- 2 × relay module
- I/O module ...

Table 8: Power Requirement: Example Calculation

Head station	1,700 mA
5 × 16-channel digital input module (25 mA)	– 125 mA
5 × 16-channel digital output module (40 mA)	– 200 mA
11 × 8-channel analog input module (69 mA)	– 759 mA
10 × 8-channel analog output module (61 mA)	– 610 mA
Remaining total system supply current At this point, an additional supply module must be used!	6 mA
Supply module	2,000 mA
2 × relay module (100 mA)	– 200 mA
I/O module ...	– ...

Field Supply Power Requirement: Example Calculation

The field supply layout must be handled in a similar manner as the system supply. In addition, power requirements for external actuators and sensors must be taken into account. Additional supply modules may be needed. Detailed product information is available in the respective  **Product Manual**.

Determining Power Loss

Power loss depends on the node structure and the applied field signals. To roughly determine power loss, use:

- Head station: 3 W

- I/O module: 1 W

5.6.2 I/O Test

With the WAGO I/O System, it is possible to test your wiring simply and effectively using an I/O test.

For example, WAGO software solutions such as **e!COCKPIT** and **WAGO-I/O-CHECK** make it possible to:

- Switch inputs and outputs
- Display digital input states
- Display analog input values
- Output analog values

Detailed instructions are available in the  product manual for **e!COCKPIT** and **WAGO-I/O-CHECK**.

Transport and Storage

The original packaging offers optimal protection during transport and storage.

- Store the products in suitable packaging; preferably, in the original packaging.
- Only transport the products in suitable containers/packaging.
- Make sure the product contacts are not contaminated or damaged when packing or unpacking.
- Observe the specified ambient climatic conditions for transport and storage of the products.

Assembly and Disassembly

DANGER

Do not work on products while energized!

High voltage can cause electric shock or burns!

- Disconnect all power sources from the product before performing any installation, repair or maintenance.

Note

Note planning documents!

The structure of the node and installation in the system may only be carried out in accordance with the planning documents provided by the system planner.

The following information must be provided:

- Information about the correct node structure
- Information about permissible mechanical, electrical and climatic ambient conditions
- Circuit diagrams
- Mounting position, cable types and lengths

7.1 Assembly Sequence

The components of the I/O system must be snapped directly onto a DIN-rail. Starting with the head station, the I/O modules must be installed from left to right according to the project design, in the nominal mounting position.

7.2 Snapping the Head Station to the DIN-Rail

1. Snap the head station onto the DIN-rail.
2. To attach the head station to the DIN-rail, use an operating tool to turn the DIN-rail locking cam until the nose of the DIN-rail locking cam engages behind the DIN-rail.

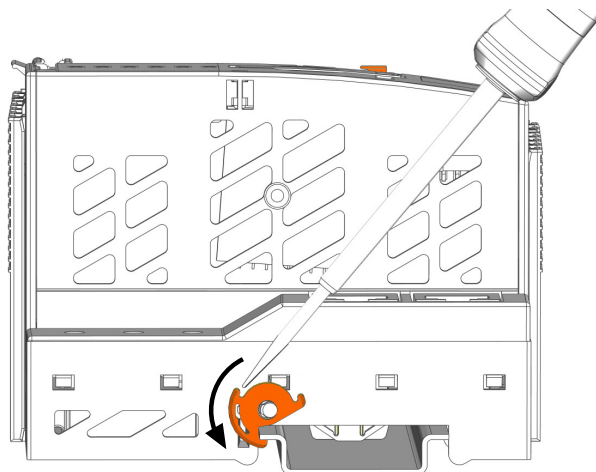

Figure 22: Locking the Head Station

⇒ The head station is now locked on the DIN-rail.

7.3 Attaching an I/O Module

1. Position the I/O module in such a way that the groove and spring are connected to the preceding and following components.

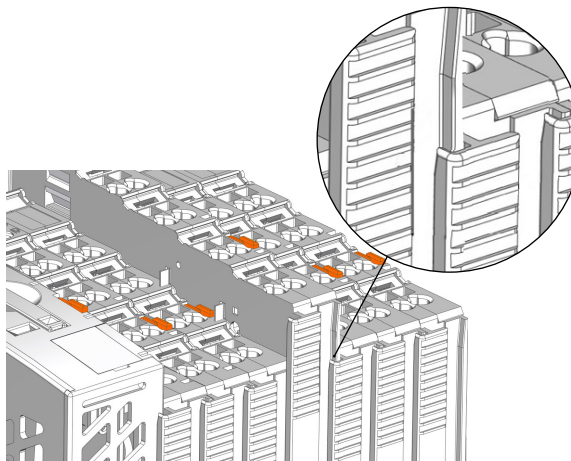

Figure 23: Inserting the I/O Module

2. Press the I/O module into the assembly until the I/O module snaps into the DIN-rail.

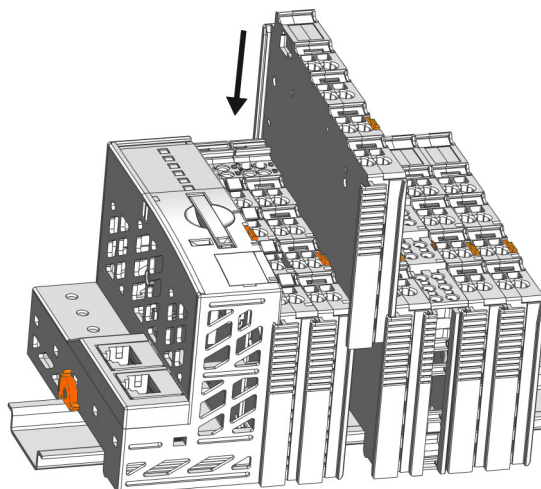

Figure 24: Snapping in the I/O Module

3. Check that the I/O module is seated securely on the mounting rail and in the assembly.
 - ⇒ Once the I/O module has snapped into place, the electrical connections for the data contacts and power contacts (if any) to the head station or to the preceding and, if applicable, following I/O module are established.

Attaching the 753 Series Wiring Interface

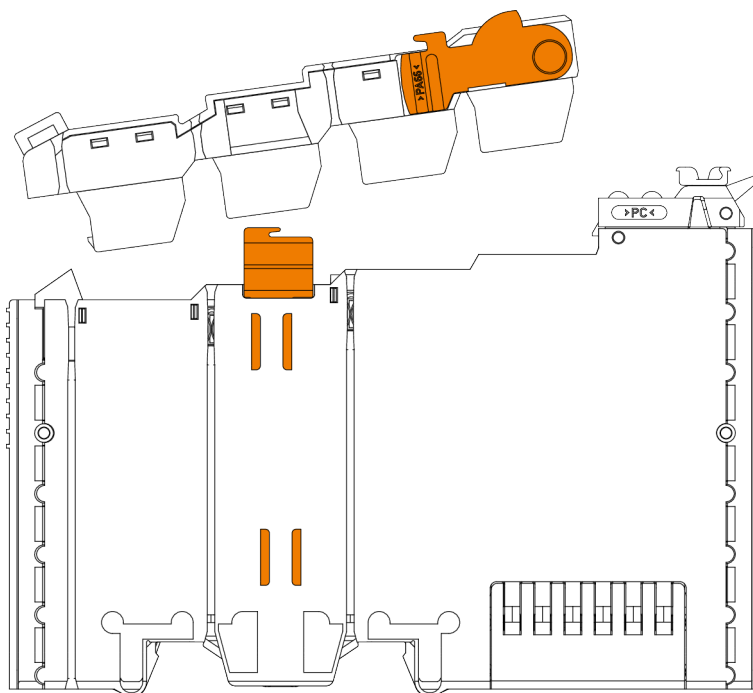

Figure 25: 753 Series Wiring Interface and I/O Module

1. Make sure that the locking tab of the I/O module is not pulled out.
2. Put the wiring interface on the I/O module.
3. Press the wiring interface onto the I/O module until it clicks into place completely.

7.4 Removing a Head Station from the DIN-Rail

Follow these steps to remove a head station from a DIN-rail:

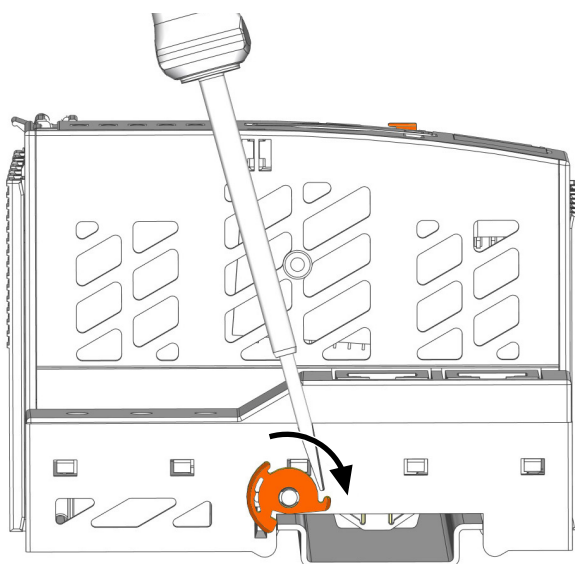

Figure 26: Disengage the locking cam

1. Use an operating tool to turn the DIN-rail locking cam until the nose of the DIN-rail locking cam disengages from the DIN-rail.

2. Use the release tab to pull the head station off the DIN-rail and, if necessary, out of the assembly. To remove head stations with two release tabs, both tabs must be pulled at the same time!
- ⇒ When the head station is pulled out of an assembly, the electrical connections of the data contacts or power jumper contacts to the subsequent I/O module are separated.

7.5 Removing the I/O Module

An I/O module can be detached from the DIN-rail using its release tab and pulling it out of the assembly.

Removing 750 Series I/O Modules

1. Pull up the orange release tab on the I/O module. To remove I/O modules with two release tabs from a group, both tabs must be pulled at the same time!

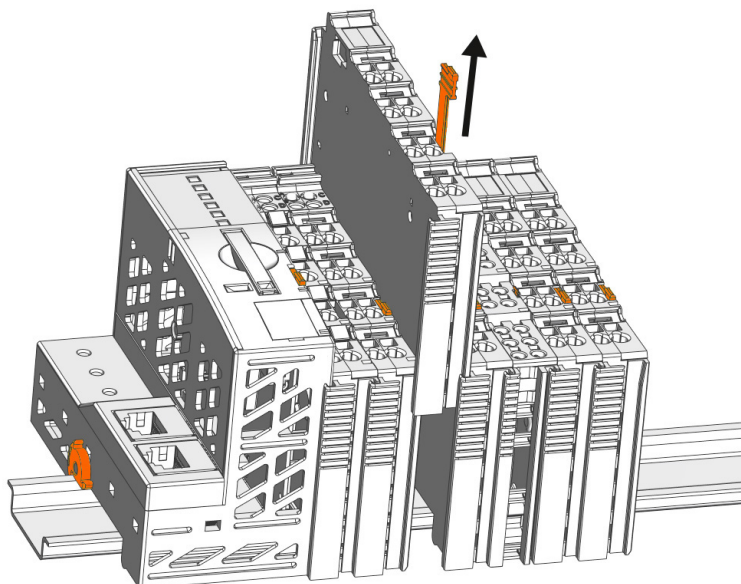

Figure 27: Pull the release tab

2. Pull the I/O module out of the assembly by the release tab.
- ⇒ When the I/O module is pulled out of the assembly, the electrical connections of the data and power contacts are separated.

Removing 753 Series I/O Modules

1. Remove the pluggable connector by pulling the orange locking latch towards the top edge of the I/O module.
- ⇒ The release tab is then accessible.

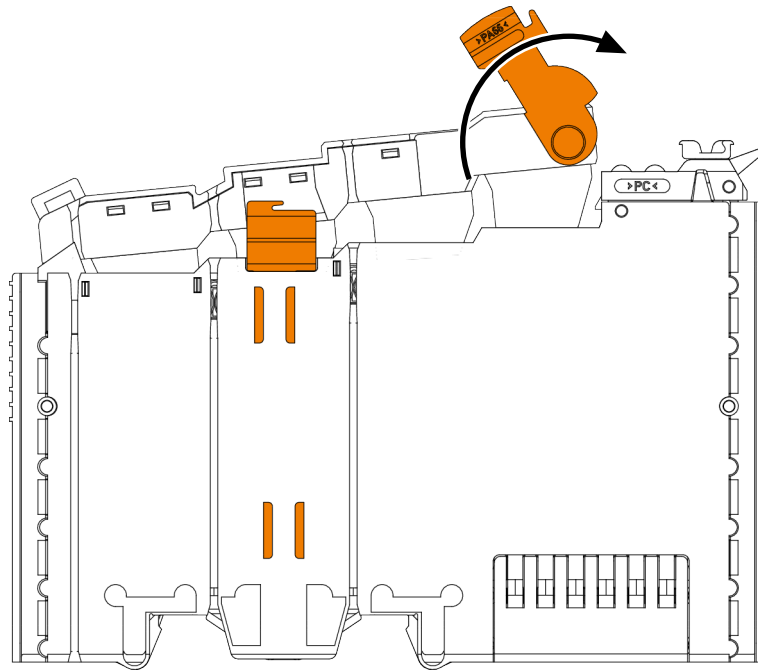

Figure 28: Pulling the Locking Latch

2. Pull up the orange release tab on the I/O module.

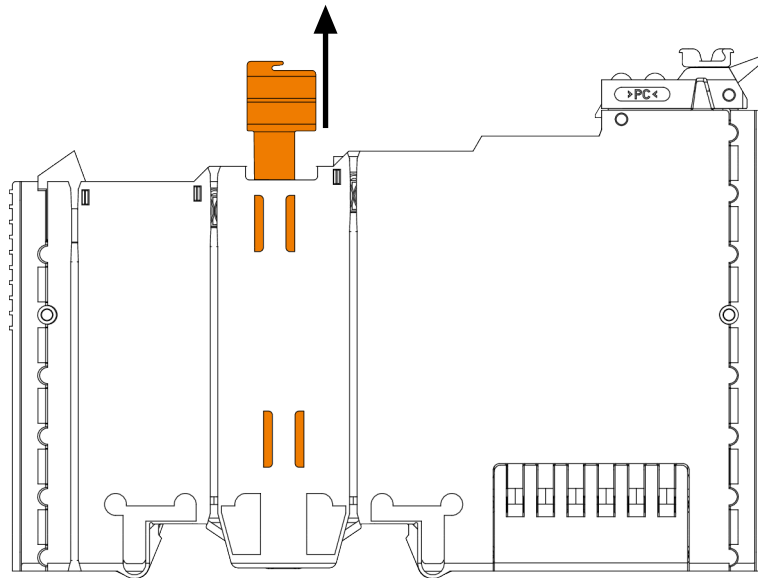

Figure 29: Detaching the 753 Series I/O Module

3. Pull the I/O module out of the assembly by the release tab.
 - ⇒ When the I/O module is pulled out of the assembly, the electrical connections of the data and power contacts are separated.

7.6 Assembling/Disassembling Components

7.6.1 Inserting Coding Keys

For 753 Series I/O modules, the connection between the I/O module and the pluggable connector can be coded. For the coding, proceed as follows:

1. Insert the pin into the socket.

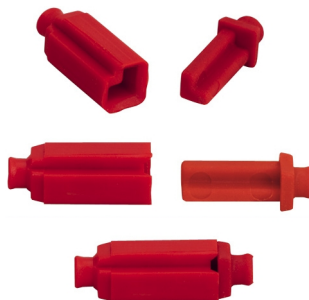

Figure 30: Putting the Coding Keys Together

2. Position the assembled coding keys in the I/O module.

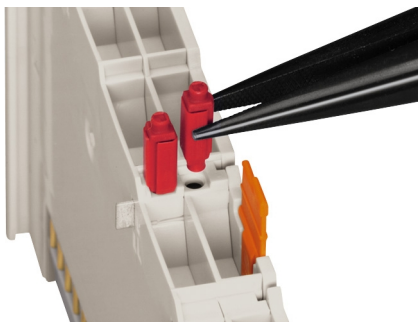

Figure 31: Inserting Coding Keys

⇒ Due to its design, each coding pin allows four different coding options (i.e.; 16 different options using two coding keys).

3. Put the pluggable connector on the I/O module.

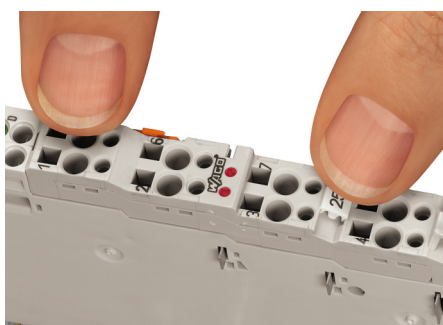

Figure 32: Plugging the Connector into Place

⇒ After removing the pluggable connector, the sockets remain in the I/O module.

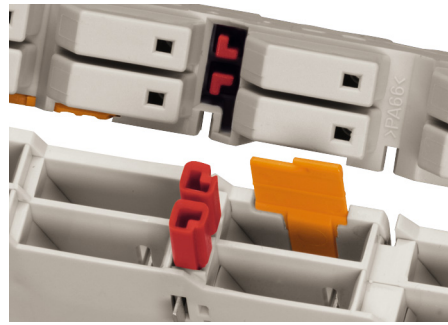

Figure 33: Coding Keys for Clear Assignment

Conductor Termination

8.1 Connect Conductor to CAGE CLAMP®

CAGE CLAMP®- and Push-in CAGE CLAMP® Connectors are designed for solid, stranded and fine-stranded conductors.

Solid, stranded and fine-stranded conductors are terminated by pushing them into Push-in CAGE CLAMP® Connectors. For all types of conductors, an operating tool must be used to open the Push-in CAGE CLAMP® and CAGE CLAMP®. Only 1 conductor may be connected to each clamping unit.

To connect a conductor, proceed as follows:

- ✓ You need an operating tool.
 - 1. Insert the operating tool into the rectangular opening above the connection to open the CAGE CLAMP®.
 - 2. Insert the conductor into the corresponding connection opening (round housing opening).
 - 3. Remove the operating tool again to close CAGE CLAMP®.
- ⇒ The conductor is now securely clamped.

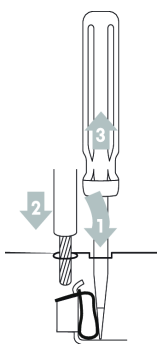

Connect a conductor to a CAGE CLAMP®.

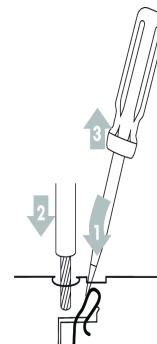

Connect a conductor to a CAGE CLAMP®.

Decommissioning

9.1 Shutting Down

1. Bring the process to a secure stop.
2. Disconnect the respective system component from the power supply.
3. Check if the voltage is isolated.
4. Protect the system component from accidental or unauthorized restart.
5. Switch off any system and/or field supply to the node that is still connected. The order has no effect.

⇒ The node does not carry any power and the product can be dismantled ( **Assembly and Disassembly** [[▶ 44](#)]).

9.2 Disposal and Recycling

Table 9: WEEE Mark

Logo	Description
	Electrical and electronic equipment may not be disposed of with household waste. This also applies to products without this mark.

Electrical and electronic equipment contain materials and substances that can be harmful to the environment and health. Electrical and electronic equipment must be disposed of properly after use. Environmentally friendly disposal benefits health, protects the environment from harmful substances in electrical and electronic equipment and enables sustainable and efficient use of resources.

- Observe national and local regulations for the disposal of batteries, packaging and electrical and electronic equipment.
- Clear any data stored on electrical and electronic equipment.
- Remove any batteries or memory cards installed in electrical and electronic equipment.
- Dispose of all types of packaging to ensure a high level of recovery, reuse and recycling.
- Have electrical and electronic equipment sent to a local collection point.
- The guidelines 2006/66/EG, PPWD 2018/852/EU and WEEE 2012/19/EU apply throughout Europe. National directives and laws may vary.

Appendix

10.1 Installation Regulations Specified by Approvals

Use in hazardous locations

The following warning notices are to be posted in the immediate proximity of the product (WAGO I/O System 750/753):

- **WARNING – DO NOT REMOVE OR REPLACE FUSED WHILE ENERGIZED!**
- **WARNING – DO NOT DISCONNECT WHILE ENERGIZED!**
- **WARNING – ONLY DISCONNECT IN A NON-HAZARDOUS AREA!**

Before using the components, check whether the intended application is permitted in accordance with the respective printing. Pay attention to any changes to the printing when replacing components.

The product is open type equipment. As such, the product must only be installed in appropriate enclosures or electrical operation rooms to which the following applies:

- Can only be opened using a tool or key.
- Inside pollution degree 1 or 2.
- In operation, internal air temperature within the highest minimum value and lowest maximum value of the permissible surrounding air temperature of all components
- Minimum degree of protection: min. IP54 (acc. to EN/IEC 60529)
- For use in Zone 2 (Gc), compliance with the applicable requirements of the standards EN/IEC/ABNT NBR IEC 60079-0, -11, -15
- For use in Zone 22 (Dc), compliance with the applicable requirements of the standards EN/IEC/ABNT NBR IEC 60079-0, -11, -15 and -31
- For use in mining (Mb), minimum degree of protection IP64 (acc. EN/IEC 60529) and adequate protection acc. EN/IEC/ABNT NBR IEC 60079-0 and -1
- Depending on zoning and device category, correct installation and compliance with requirements must be assessed and certified by a "Notified Body" (ExNB) if necessary!

Explosive atmosphere occurring simultaneously with assembly, installation or repair work must be ruled out. Among other things, these include the following activities:

- Insertion and removal of components
- Connecting or disconnecting from fieldbus, antenna, D-Sub, ETHERNET or USB connections, DVI ports, memory cards, configuration and programming interfaces in general and service interface in particular
- Operating DIP switches, coding switches or potentiometers
- Replacing fuses

Wiring (connecting or disconnecting) of non-intrinsically safe circuits is only permitted in the following cases:

- The circuit is disconnected from the power supply.
- The area is known to be non-hazardous.

Outside the device, suitable measures must be taken so that the rated voltage is not exceeded by more than 40 % due to transient faults (e.g., when powering the field supply).

Product components intended for intrinsically safe applications may only be powered by supply modules which are intended for intrinsically safe applications themselves.

Only field devices whose power supply corresponds to overvoltage category I or II may be connected to these components.

For UL HazLoc acc. UL File E198726, the following additional requirements apply:

- Use in Class I, Division 2, Group A, B, C, D or non-hazardous areas only.
- ETHERNET connections are used exclusively for connecting to computer networks (LANs) and may not be connected to telephone networks or telecommunication cables.
- WARNING – Product components with fuses must not be fitted into circuits subject to overloads! These include, e.g., motor circuits.

Because the following information refers to language-specific regulations, standards or certifications applicable to the specific installation and operation location, it is presented in the respective original language.

UL Hazardous Locations

This equipment is suitable for use in Class I, Division 2, Groups A, B, C and D Or nonhazardous locations only.

This equipment is an OPEN-TYPE device meant to be installed in an enclosure suitable for the environment and that is only accessible with the use of a tool.

English	French
WARNING - EXPLOSION HAZARD - DO NOT DISCONNECT WHILE THE CIRCUIT IS LIVE OR THE AREA IS FREE OF IGNITABLE CONCENTRATIONS.	AVERTISSEMENT – RISQUE D’EXPLOSION – NE PAS DÉBRANCHER PENDANT QUE LE CIRCUIT EST SOUS TENSION OU QUE L’EMPLACEMENT NE SOIT EXEMPT DE CONCENTRATIONS INFLAMMABLES.
WARNING - DO NOT DISCONNECT EQUIPMENT UNLESS POWER HAS BEEN SWITCHED OFF OR THE AREA IS KNOWN TO BE NON-HAZARDOUS	ATTENTION – NE DÉBRANCHER L'APPAREIL QU'EN L'ABSENCE DE COURANT OU LORSQUE LA ZONE EST CONSIDÉRÉE SANS RISQUE D'EXPLOSION.
WARNING - EXPLOSION HAZARD - SUBSTITUTION OF COMPONENTS MAY IMPAIR SUITABILITY FOR CLASS I, DIV. 2.	ATTENTION – DANGER D'EXPLOSION – L'ÉCHANGE DE COMPOSANTS PEUT ALTÉRER L'APTITUDE DE CLASSE I, DIV. 2.

For specific modules

English	French
WARNING - USE MODULE 750-642 ONLY WITH ANTENNA MODULE 758 -910	AVERTISSEMENT : UTILISEZ LE MODULE RÉF. 750-642 UNIQUEMENT AVEC LE MODULE D'ANTENNE RÉF. 758-910 !

Module 750-538 only

Manual shall contain CONTROL DRAWING No.750538 with its entity parameters. “In Hazardous Locations, Non-Incendive only when installed per Control Drawing No. 750538”

The Modules 750-439, 0750-0486, 750-538, 0750-0539, 750-633, 750-663/000-003, 750-489 shall only be supplied with 750-606 or 750-625/000-001. For Models 0750-0439/0040-0000, 0750-0481/0040-0000, 0750-0484/0040-0000, 0750-0486/0040-0000, 0750-0535/0040-0000, 0750-0585/0040-0000, 0750

-0586/0040-0000, and 0750-0633/0040-0000 manual shall contain “Shall only be operated with a power supply 24 Vdc Diagnosis for Ex I XTR Modules 0750-0606/0040-0000” or similar statement

For head stations containing SD card reader sockets only:

English	French
WARNING: DO NOT CONNECT OR DISCONNECT SD-CARD WHILE CIRCUIT IS LIVE UNLESS THE AREA IS KNOWN TO BE FREE OF IGNITABLE CONCENTRATIONS OF FLAMMABLE GASES OR VAPORS.	AVERTISSEMENT: NE PAS BRANCHER NI DÉBRANCHER <i>SD-CARD</i> PENDANT QUE LE CIRCUIT EST SOUS TENSION À MOINS QUE L'EMPLACEMENT NE SOIT EXEMPT DE CONCENTRATIONS INFLAMMABLES.

For devices with Ether CAT/Ethernet connectors: Only for use in LAN, not for connection to telecommunication circuits.

For head stations only: The configuration interface Service connector is for temporary connection only. Do not connect or disconnect unless the area is known to be non-hazardous. Connection or disconnection in an explosive atmosphere could result in an explosion.

For devices containing fuses:

English	French
WARNING – EXPLOSION HAZARD. DO NOT REMOVE OR REPLACE FUSES UNLESS POWER HAS BEEN DISCONNECTED OR THE AREA IS FREE OF IGNITIBLE CONCENTRATIONS.	AVERTISSEMENT – RISQUE D'EXPLOSION. NE PAS RETIRER NI REMPLACER LES FUSIBLE À MOINS QUE L'ALIMENTATION N'AIT ÉTÉ COUPÉE OU QUE L'EMPLACEMENT NE SOIT EXEMPT DE CONCENTRATIONS INFLAMMABLES.
WARNING - DEVICES CONTAINING FUSES MUST NOT BE FITTED INTO CIRCUITS SUBJECT TO OVERLOADS, E.G. MOTOR CIRCUITS	ATTENTION – DES APPAREILS AVEC FUSIBLES NE DOIVENT PAS ÊTRE INTÉGRÉS DANS DES CIRCUITS QUI SONT SOUMIS À UNE SURCHARGE, PAR EX. DES CIRCUITS DE MOTEUR.

A switch suitable for the location where the equipment is installed shall be provided to remove the power from the fuse.

10.2 Protected Rights

- Adobe® and Acrobat® are registered trademarks of Adobe Systems Inc.
- Android™ is a trademark of Google LLC.
- Apple, the Apple logo, iPhone, iPad and iPod touch are registered trademarks of Apple Inc. registered in the USA and other countries. “App Store” is a service mark of Apple Inc.
- AS-Interface® is a registered trademark of the AS-International Association e.V.
- BACnet® is a registered trademark of the American Society of Heating, Refrigerating and Air Conditioning Engineers, Inc. (ASHRAE).
- *Bluetooth*® is a registered trademark of Bluetooth SIG, Inc.
- CiA® and CANopen® are registered trademarks of CAN in AUTOMATION – International Users and Manufacturers Group e.V.
- CODESYS is a registered trademark of CODESYS Development GmbH.
- DALI is a registered trademark of the Digital Illumination Interface Alliance (DiiA).
- EtherCAT® is a registered trademark and patented technology licensed by Beckhoff Automation GmbH, Germany.

- ETHERNET/IP™ is a registered trademark of the Open DeviceNet Vendor Association, Inc (ODVA).
- EnOcean® is a registered trademark of EnOcean GmbH.
- Google Play™ is a registered trademark of Google Inc.
- IO-Link is a registered trademark of PROFIBUS Nutzerorganisation e.V.
- KNX® is a registered trademark of the KNX Association cvba.
- Linux® is a registered trademark of Linus Torvalds.
- LON® is a registered trademark of the Echelon Corporation.
- Modbus® is a registered trademark of Schneider Electric, licensed for Modbus Organization, Inc.
- OPC UA is a registered trademark of the OPC Foundation.
- PROFIBUS® is a registered trademark of the PROFIBUS Nutzerorganisation e.V. (PNO).
- PROFINET® is a registered trademark of the PROFIBUS Nutzerorganisation e.V. (PNO).
- QR Code is a registered trademark of DENSO WAVE INCORPORATED.
- Subversion® is a trademark of the Apache Software Foundation.
- Windows® is a registered trademark of Microsoft Corporation.

List of Tables

Table 1	Color coding of Component Types	17
Table 2	Color coding of component classes	17
Table 3	Explanation of the Marking Example	18
Table 4	Explanation of the Different Marking Example	19
Table 5	Production number.....	20
Table 6	Update Matrix.....	20
Table 7	High-Isolation Filter Modules	34
Table 8	Power Requirement: Example Calculation	41
Table 9	WEEE Mark	52

List of Figures

Figure 1	Example housing of the head stations	11
Figure 2	Example housing of the I/O modules	11
Figure 3	Example PFC View	12
Figure 4	Example View of the Controller.....	13
Figure 5	I/O module 750 Series with CAGE CLAMP® connections (example).....	14
Figure 6	I/O module 750 Series with Push-in CAGE CLAMP® connections (example)	15
Figure 7	I/O module 753 Series (example)	16
Figure 8	Data Contacts	21
Figure 9	Example: Power Jumper Contact Arrangement (left: male contacts; right: spring contacts)	21
Figure 10	DIN-Rail Contact (example).....	22
Figure 11	Display of Different Potential Groups	23
Figure 12	System Supply Input (example).....	24
Figure 13	Field Supply Input (example)	25
Figure 14	Installation Clearances.....	30
Figure 15	Coordinate model: width (x), height (y), depth (z).....	30
Figure 16	Power Supply Concept for Marine Applications – Class A and B	35
Figure 17	Power Supply Concept for Marine Applications – Class A and B with FE Power Jumper Contact.....	36
Figure 18	Ex i Power Supply Concept	37
Figure 19	Power Supply Concept for Marine Applications in Ex i Zone – Class A	38
Figure 20	Power Supply Concept for Marine Applications in Ex i Zone – Class B	39
Figure 21	Power Supply Concept Example with F I/O-Modules	40
Figure 22	Locking the Head Station.....	44
Figure 23	Inserting the I/O Module.....	45
Figure 24	Snapping in the I/O Module	45
Figure 25	753 Series Wiring Interface and I/O Module	46
Figure 26	Disengage the locking cam.....	46
Figure 27	Pull the release tab	47
Figure 28	Pulling the Locking Latch	48
Figure 29	Detaching the 753 Series I/O Module	48
Figure 30	Putting the Coding Keys Together	49
Figure 31	Inserting Coding Keys.....	49
Figure 32	Plugging the Connector into Place.....	49
Figure 33	Coding Keys for Clear Assignment	50

WAGO GmbH & Co. KG

Postfach 2880 · D - 32385 Minden
Hansastraße 27 · D - 32423 Minden

✉ info@wago.com

🌐 www.wago.com

Headquarters	+49 571/887 – 0
Sales	+49 (0) 571/887 – 44 222
Order Service	+49 (0) 571/887 – 44 333
Fax	+49 571/887 – 844169

WAGO is a registered trademark of WAGO Verwaltungsgesellschaft mbH.

Copyright – WAGO GmbH & Co. KG – All rights reserved. The content and structure of the WAGO websites, catalogs, videos and other WAGO media are subject to copyright. Distribution or modification of the contents of these pages and videos is prohibited. Furthermore, the content may neither be copied nor made available to third parties for commercial purposes. Also subject to copyright are the images and videos that were made available to WAGO GmbH & Co. KG by third parties.



**SCATTERGOOD
& JOHNSON LTD**
ELECTRICAL ENGINEERING & FLUID CONTROL DISTRIBUTORS

Est.1899

At Scattergood & Johnson Ltd, we pride ourselves on being a technical distributor to specialist industries.

Working with a range of quality product manufacturers across a number of specialist markets, we are not your average 'box shifter' - we are your technical and supply chain partner.

We fully support every product we sell - for free! Our internal team and external sales engineers can answer any product or application question, no matter the complexity.

Backing up this technical ability is a range of 50,000+ products available from stock for nationwide next day delivery (same day if required!), or you can collect what you need from any of our trade counters around the UK.

Select your specialist interest below to learn more about how we can help.

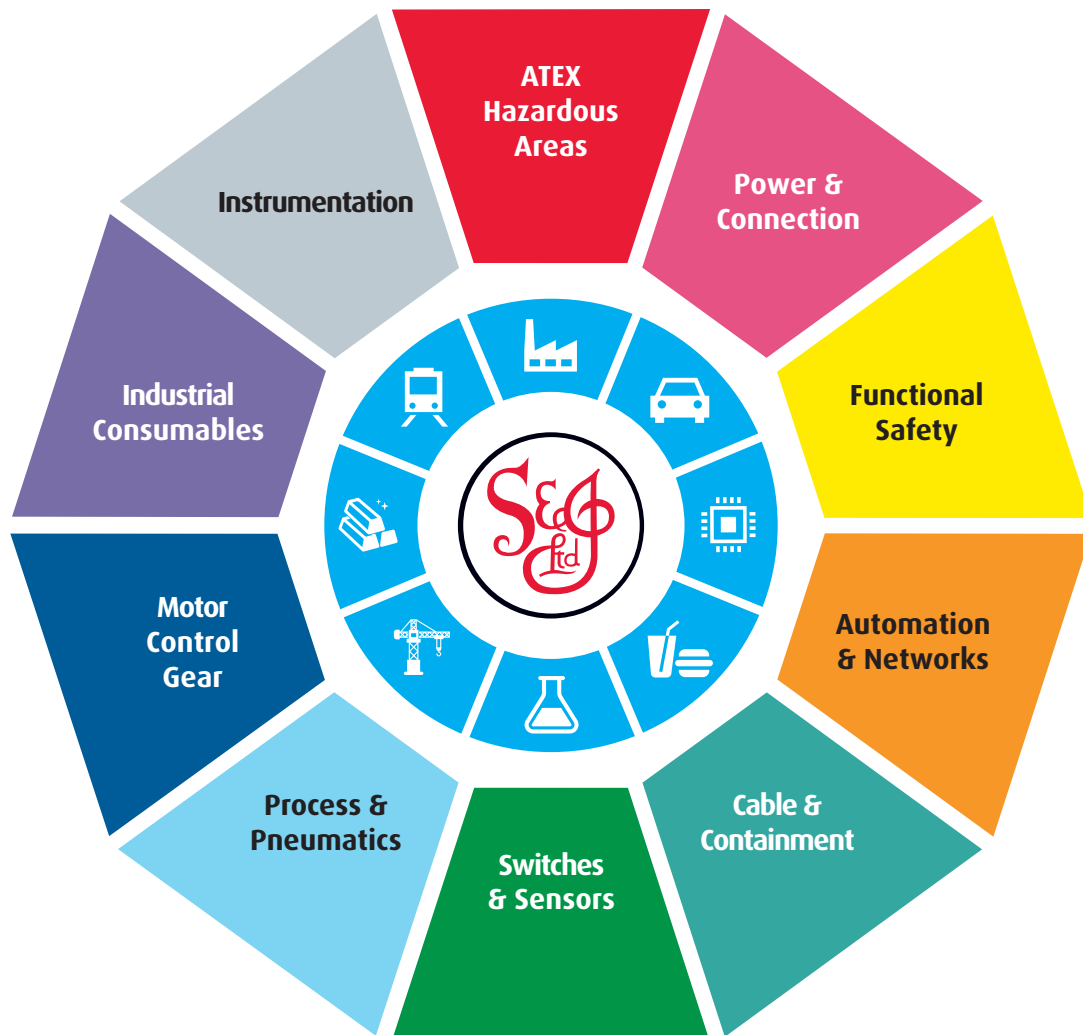

Online, In Branch and On the Road - Scattergood & Johnson Ltd, there when you need us.

www.scatts.co.uk