

WAGO → I/O → SYSTEM 750

Fieldbus Independent I/O Modules

2-Channel Up/Down Counter / 500
Hz
750-638(/xxx-xxx)



Manual

Version 1.0.3



Copyright © 2006 by WAGO Kontakttechnik GmbH & Co. KG
All rights reserved.

WAGO Kontakttechnik GmbH & Co. KG

Hansastraße 27
D-32423 Minden

Phone: +49 (0) 571/8 87 – 0

Fax: +49 (0) 571/8 87 – 1 69

E-Mail: info@wago.com

Web: <http://www.wago.com>

Technical Support

Phone: +49 (0) 571/8 87 – 5 55

Fax: +49 (0) 571/8 87 – 85 55

E-Mail: support@wago.com

Every conceivable measure has been taken to ensure the correctness and completeness of this documentation. However, as errors can never be fully excluded, we would appreciate any information or ideas at any time.

E-Mail: documentation@wago.com

We wish to point out that the software and hardware terms as well as the trademarks of companies used and/or mentioned in the present manual are generally trademark or patent protected.

CONTENT

1	Important Comments	4
1.1	Legal Principles	4
1.1.1	Copyright	4
1.1.2	Personnel Qualification	4
1.1.3	Intended Use	4
1.2	Symbols	5
1.3	Number Notation	5
1.4	Safety Notes	6
1.5	Scope	6
2	I/O Modules	7
2.1	Counter Modules	7
2.1.1	750-638(/xxx-xxx) [2-Channel Up/Down Counter / 500 Hz]	7
2.1.1.1	Variations	7
2.1.1.2	View	7
2.1.1.3	Description	8
2.1.1.4	Display elements	9
2.1.1.5	Schematic Diagram	10
2.1.1.6	Technical Data	11
2.1.1.7	Process Image	12
2.1.1.8	Data Transfer	13
2.1.1.9	Example: Set counter 1 on value 100 and count forward	14

1 Important Comments

To ensure fast installation and start-up of the units described in this manual, we strongly recommend that the following information and explanations are carefully read and abided by.

1.1 Legal Principles

1.1.1 Copyright

This manual is copyrighted, together with all figures and illustrations contained therein. Any use of this manual which infringes the copyright provisions stipulated herein, is not permitted. Reproduction, translation and electronic and photo-technical archiving and amendments require the written consent of WAGO Kontakttechnik GmbH & Co. KG. Non-observance will entail the right of claims for damages.

WAGO Kontakttechnik GmbH & Co. KG reserves the right to perform modifications allowed by technical progress. In case of grant of a patent or legal protection of utility patents all rights are reserved by WAGO Kontakttechnik GmbH & Co. KG. Products of other manufacturers are always named without referring to patent rights. The existence of such rights can therefore not be ruled out.

1.1.2 Personnel Qualification

The use of the product detailed in this manual is exclusively geared to specialists having qualifications in PLC programming, electrical specialists or persons instructed by electrical specialists who are also familiar with the valid standards. WAGO Kontakttechnik GmbH & Co. KG declines all liability resulting from improper action and damage to WAGO products and third party products due to non-observance of the information contained in this manual.

1.1.3 Intended Use

For each individual application, the components supplied are to work with a dedicated hardware and software configuration. Modifications are only permitted within the framework of the possibilities documented in the manuals. All other changes to the hardware and/or software and the non-conforming use of the components entail the exclusion of liability on part of WAGO Kontakttechnik GmbH & Co. KG.

Please direct any requirements pertaining to a modified and/or new hardware or software configuration directly to WAGO Kontakttechnik GmbH & Co. KG.

1.2 Symbols



Danger

Always abide by this information to protect persons from injury.



Warning

Always abide by this information to prevent damage to the device.



Attention

Marginal conditions must always be observed to ensure smooth operation.



ESD (Electrostatic Discharge)

Warning of damage to the components by electrostatic discharge. Observe the precautionary measure for handling components at risk.



Note

Routines or advice for efficient use of the device and software optimization.



More information

References on additional literature, manuals, data sheets and internet pages.

1.3 Number Notation

Number Code	Example	Note
Decimal	100	normal notation
Hexadecimal	0x64	C notation
Binary	'100' '0110.0100'	within inverted commas, nibble separated with dots

1.4 Safety Notes



Warning

Switch off the system prior to working on bus modules!

In the event of deformed contacts, the module in question is to be replaced, as its functionality can no longer be ensured on a long-term basis.

The components are not resistant against materials having seeping and insulating properties. Belonging to this group of materials is: e.g. aerosols, silicones, triglycerides (found in some hand creams).

If it cannot be ruled out that these materials appear in the component environment, then additional measures are to be taken:

- installation of the components into an appropriate enclosure
 - handling of the components only with clean tools and materials.
-



Attention

Cleaning of soiled contacts may only be done with ethyl alcohol and leather cloths. Thereby, the ESD information is to be regarded.

Do not use any contact spray. The spray may impair the functioning of the contact area.

The WAGO-I/O-SYSTEM 750 and its components are an open system. It must only be assembled in housings, cabinets or in electrical operation rooms. Access must only be given via a key or tool to authorized qualified personnel.

The relevant valid and applicable standards and guidelines concerning the installation of switch boxes are to be observed.



ESD (Electrostatic Discharge)

The modules are equipped with electronic components that may be destroyed by electrostatic discharge. When handling the modules, ensure that the environment (persons, workplace and packing) is well grounded. Avoid touching conductive components, e.g. gold contacts.

1.5 Scope

This manual describes the Digital Input Module 750-638(/xxx-xxx) 2-Channel Up/Down Counter / 500 Hz of the modular WAGO-I/O-SYSTEM 750.

Handling, assembly and start-up are described in the manual of the Fieldbus Coupler. Therefore this documentation is valid only in the connection with the appropriate manual.

2 I/O Modules

2.1 Counter Modules

2.1.1 750-638(/xxx-xxx) [2-Channel Up/Down Counter / 500 Hz]

2-Channel Up/Down Counter DC 24 V, 16 Bit, 500 Hz

2.1.1.1 Variations

Item-No.	Designation	Description
750-638	2-Channel Up/Down Counter / 500 Hz	2-Channel Up/Down Counter DC 24 V, 500 Hz
750-638/025-000	2-Channel Up/Down Counter / 500 Hz/T	2-Channel Up/Down Counter DC 24 V, 500 Hz extended temperature range from -20 °C to +60 °C

2.1.1.2 View

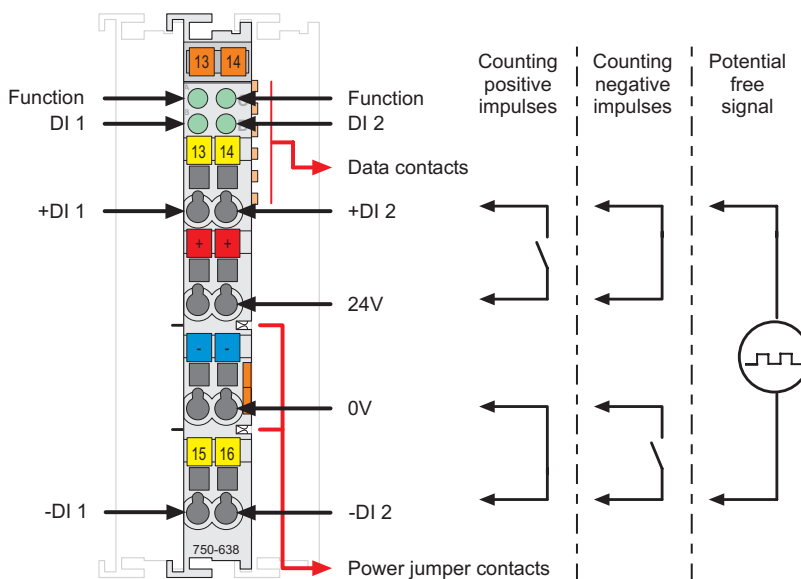

Fig. 2.1.1-1: 2-Channel Up/Down Counter 750-638

g063800e

8 • 750-638(/xxx-xxx) [2-Channel Up/Down Counter / 500 Hz]**Description**

2.1.1.3 Description

The 2-channel counter module 750-638 counts 24 V DC binary pulses from digital field devices (sensors, switches, etc.) forward and backwards.

This I/O module has two independent 16 bit up/down counters. One field device per channel can be directly connected independent of the wiring.

The counters are only equipped with terminals on the field side. Since both counters are potential free, the external 24 V pulse signals can be directly connected to -DI 1 and +DI 1 or -DI 2 and +DI 2.

By using the ground potential of the module, each counter can count either positive or negative pulses independent of the external module wiring.

By connecting, for example, two 2-conductor field devices, one to the upper signal input +DI 1 or +DI 2 and the other to the 24 V connection, as well as connecting the 0 V signal and the corresponding lower signal -DI 1 or -DI 2 in a bridged mode, positive voltage pulses can be identified and counted via the 24 V signals sent to + DI 1 or +DI 2.

By connecting, for example, two 2-conductor field devices, one to the lower signal input -DI 1 or -DI 2 and the other to the 0 V connection, as well as connecting the 24 V signal and the corresponding upper signal +DI 1 or +DI 2 in a bridged mode, negative voltage pulses can be identified and counted via the 0 V signals sent to -DI 1 or -DI 2.

Channel-wise mixed wiring of the counters is possible (counting with potential free signal, with positive and negative pulse).

Each I/O module delivers 3 bytes per channel.

Two of them are delivered by the count data, which is transmitted to the control system as a 16-bit value via the fieldbus. The third byte is a control/status byte, which is used for the bidirectional data exchange of the bus module with the upper level control system.

The control byte is transmitted from the control system to the I/O module and the status byte from the I/O module to the control system.

The control bytes are used to set, reset and lock the counters. Defining the counting direction of the counters (incrementing or decrementing the count) is also possible via setting within the control byte.

The content of the control byte is acknowledged by the status byte after the preset counter function has been processed.

An individual green status LED indicates the presence of a counting pulse at the channels. Communication with the coupler/controller is indicated by an additional green function LED.

Field and system levels are electrically isolated.

The individual I/O modules can be arranged freely when designing the field-bus node. A block-wise arrangement of the modules is not required.

The 24 V voltage supplying the field level and the 0 V potential is provided to the up/down counter module either using a preconnected I/O module or a supply module. Power connections are made automatically from module to module via the internal power contacts when the input modules are snapped onto the DIN rail.



Warning

The maximum current of the internal power jumper contacts is 10 A. When configuring the system it is important not to exceed the maximum/sum current. However, if such a case should occur, another supply module must be added.

The up/down counter module can be operated with all couplers/controllers of the WAGO-I/O-SYSTEM 750 (except for the digital only versions 750-320, 750-323, 750-324 and 750-327).

2.1.1.4 Display elements

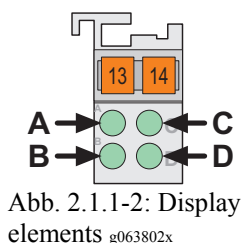

LED	Channel	Designation	State	Function
A green	1	Function DI 1	off	Counter 1: no communication with coupler/controller
			on	Counter 1: communication with coupler/controller
B green		Status DI 1	off	Counter 1: signal input off
			on	Counter 1: DC 24 V signal input on
C green	2	Function DI 2	off	Counter 2: no communication with coupler/controller
			on	Counter 2: communication with coupler/controller
D green		Status DI 2	off	Counter 2: signal input off
			on	Counter 2: DC 24 V signal input on

**10 • 750-638(/xxx-xxx) [2-Channel Up/Down Counter / 500 Hz]
Schematic Diagram**

2.1.1.5 Schematic Diagram

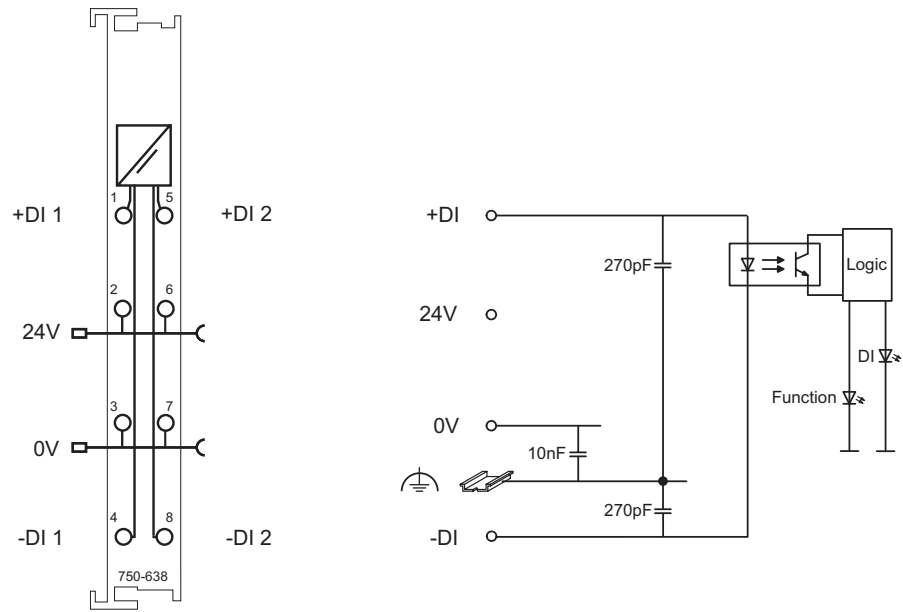





Fig. 2.1.1-3: 2-Channel Up/Down Counter 750-638

g063801e

2.1.1.6 Technical Data

Module Specific Data		
Number of counters	2	
Nominal voltage	DC 24V (-15% to +20%)	
Input current _{typ.} (internal)	10 mA	
Signal voltage (0)	DC -3 V to +5 V (acc. to EN 61131 type 1)	
Signal voltage (1)	DC 15 V to 30 V (acc. to EN 61131 type 1)	
Common-mode voltage	DC 500 V	
Input filter	2 ms	
Sensor connection	differential	
Switching rate _{max.}	500 Hz	
Counter depth	16 bits	
Isolation	500 V (System/Supply)	
Internal bit width	2 x 16 bits data 2 x 8 bits control/status	
Dimensions (mm) W x H x L	12 x 64* x 100 * from upper edge of DIN 35 rail	
Weight	ca. 55g	
Standards and Regulations (cf. Chapter 2.2 of the Coupler/Controller Manual)		
EMC-Immunity to interference (CE)	acc. to EN 50082-2 (96)	
EMC-Emission of interference (CE)	acc. to EN 50081-1 (93)	
Approvals (cf. Chapter 2.2 of the Coupler/Controller Manual)		
	cUL _{US} (UL508)	
	cUL _{US} (UL1604)	Class I Div2 ABCD T4A
	DEMKO	II 3 GD EEx nA II T4
	Conformity Marking	

**More Information**

Detailed references to the approvals are listed in the document "Overview Approvals WAGO-I/O-SYSTEM 750", which you can find on the CD ROM ELECTRONICC Tools and Docs (Item-No.: 0888-0412) or in the internet under:

www.wago.com → Documentation → WAGO-I/O-SYSTEM 750 → System Description

12 • 750-638(/xxx-xxx) [2-Channel Up/Down Counter / 500 Hz] Process Image

2.1.1.7 Process Image

Using the I/O module 750-438, a 6 byte input and output process image can be transferred to the fieldbus coupler / controller via one logical channel. The transfer of the setting counter value in binary format is made via 4 output bytes (D0, D1) res. (D2, D3). The transfer of the counter reading in binary format is made via 4 input bytes (D0, D1) res. (D2, D3). The control bytes (C0, C1) serve for setting the counter. The status bytes (S0, S1) show the status of the counter.



Attention

The representation of the process data of some I/O modules or their variations in the process image depends on the fieldbus coupler/-controller used. Please take this information as well as the particular design of the respective control/status bytes from the section "Fieldbus Specific Design of the Process Data" included in the description concerning the process image of the corresponding coupler/controller.

Channel	Input Data		Output Data	
Counter 1	S0	Status byte	C0	Control byte
	D0	Counter value Byte 0 (LSB)	D0	Set value Byte 0 (LSB)
	D1	Counter value Byte 1 (MSB)	D1	Set value Byte 1 (MSB)
Counter 2	S1	Status byte	C1	Control byte
	D2	Counter value Byte 0 (LSB)	D2	Set value Byte 0 (LSB)
	D3	Counter value Byte 1 (MSB)	D3	Set value Byte 1 (MSB)

Control byte C0, C1							
Bit 7	Bit 6	Bit 5	Bit 4	Bit 3	Bit 2	Bit 1	Bit 0
0	0	Set Counter	Lock Counter	0	0	Backwards mode	No overflow

No overflow 1: Deactivate overflow, counter stops at 0xFFFF or 0x0000
 0: Activate overflow, counter allows overflow
 0xFFFF -> 0x0000 forward mode
 0x0000 -> 0xFFFF backward mode

Backwards mode 1: Backwards counter mode
 0: Forward counter mode

Lock Counter 1: Locks the counter
 0: Counting mode

Set Counter 1: Set counter with the set value
 0: Counting mode

0 reserved

Status byte S0, S1							
Bit 7	Bit 6	Bit 5	Bit 4	Bit 3	Bit 2	Bit 1	Bit 0
0	0	Zähler gesetzt	Zähler gesperrt	0	0	rückwärts zählen	kein Überlauf

No over-
flow 1: overflow is locked
 0: overflow allowed

Backwards
mode 1: Backward mode
 0: Forward mode

Counter is
locked 1: Counter is locked
 0: Counting mode

Counter is
set 1: Counter is set and hold
 0: Counting mode

0 reserved

2.1.1.8 Data Transfer

With the control and status byte the following tasks are possible:

- **Set Counter:**
If bit 5 in the control byte is set to "1", then the desired counter value with the 16 bit value is loaded into the output bytes 0 and 1. As long as the bit is set, the counter stops and information is stored.
The successful data loading of the counter will be conveyed by bit 5 of the status byte.
- **Lock Counter:**
If bit 4 in the control byte is set to "1", then the count process is suppressed.
Bit 4 in the status byte communicates the suppression of the counter.
- **Backwards mode:**
If bit 1 in the control byte is set to "1", then the counter counts down.
Bit 1 in the status byte communicates the counting direction.
- **No overflow:**
If bit 0 in the control byte is set to "0" and the counter gets a next impulse after the maximum value of 0xFFFF is reached, then the counter starts again with value 0x0000. In case of backwards mode, a next impulse starts the counter with value 0xFFFF after the minimum value of 0x0000 is reached.
If bit 0 in the control byte is set to "1" and the counter gets a next impulse after the maximum value (0xFFFF) or the minimum value (0x0000) is reached, then the counter stays on the current value.

14 • 750-638(/xxx-xxx) [2-Channel Up/Down Counter / 500 Hz]

Example: Set counter 1 on value 100 and count forward

2.1.1.9 Example: Set counter 1 on value 100 and count forward

**Note**

X is used if a value is not relevant.

First the counter 1 will be set to the value 100 (0x64) by "Set Counter", bit 5 of the control byte C0.

1. Enter the set value in the output data D0, D1 of counter 1.

D1	D0
0x00	0x64

2. Set with bit 5 of the control byte C0 (Set Counter) the counter 1.

Bit 7	Bit 6	Bit 5	Bit 4	Bit 3	Bit 2	Bit 1	Bit 0
0	0	1	0	0	0	0	X

3. The acknowledgement is shown in bit 5 (Counter is set) of the status byte S0.

Bit 7	Bit 6	Bit 5	Bit 4	Bit 3	Bit 2	Bit 1	Bit 0
0	0	1	0	0	0	0	X

4. Reset bit 5 (Set Counter) in the control byte C0.

Bit 7	Bit 6	Bit 5	Bit 4	Bit 3	Bit 2	Bit 1	Bit 0
0	0	0	0	0	0	0	X

5. The counter value is shown in the input data D0, D1 of counter 1.

D1	D0
0x00	0x64

750-638(/xxx-xxx) [2-Channel Up/Down Counter / 500 Hz]• 15
Example: Set counter 1 on value 100 and count forward

Now the counter 1 starts the forward counting.

D1	D0	Description
0x00	0x64	no counter impulse
0x00	0x65	1st counter impulse
0x00	0x66	2 nd counter impulse
.....
0xFF	0xFF	maximum counter value
0x00	0x00	overflow at the next impulse, if bit 0 in the control byte C0 is set on bit 0 = 0 *)
0x00	0x01	next impulse
.....	and so on

*) if bit 0 in the control byte C0 is set on bit 0 = 1, the counter stays on the maximum value.



WAGO Kontakttechnik GmbH & Co. KG
Postfach 2880 • D-32385 Minden
Hansastraße 27 • D-32423 Minden
Phone: 05 71/8 87 – 0
Fax: 05 71/8 87 – 1 69
E-Mail: info@wago.com

Internet: <http://www.wago.com>



**SCATTERGOOD
& JOHNSON LTD**
ELECTRICAL ENGINEERING & FLUID CONTROL DISTRIBUTORS

Est.1899

At Scattergood & Johnson Ltd, we pride ourselves on being a technical distributor to specialist industries.

Working with a range of quality product manufacturers across a number of specialist markets, we are not your average 'box shifter' - we are your technical and supply chain partner.

We fully support every product we sell - for free! Our internal team and external sales engineers can answer any product or application question, no matter the complexity.

Backing up this technical ability is a range of 50,000+ products available from stock for nationwide next day delivery (same day if required!), or you can collect what you need from any of our trade counters around the UK.

Select your specialist interest below to learn more about how we can help.

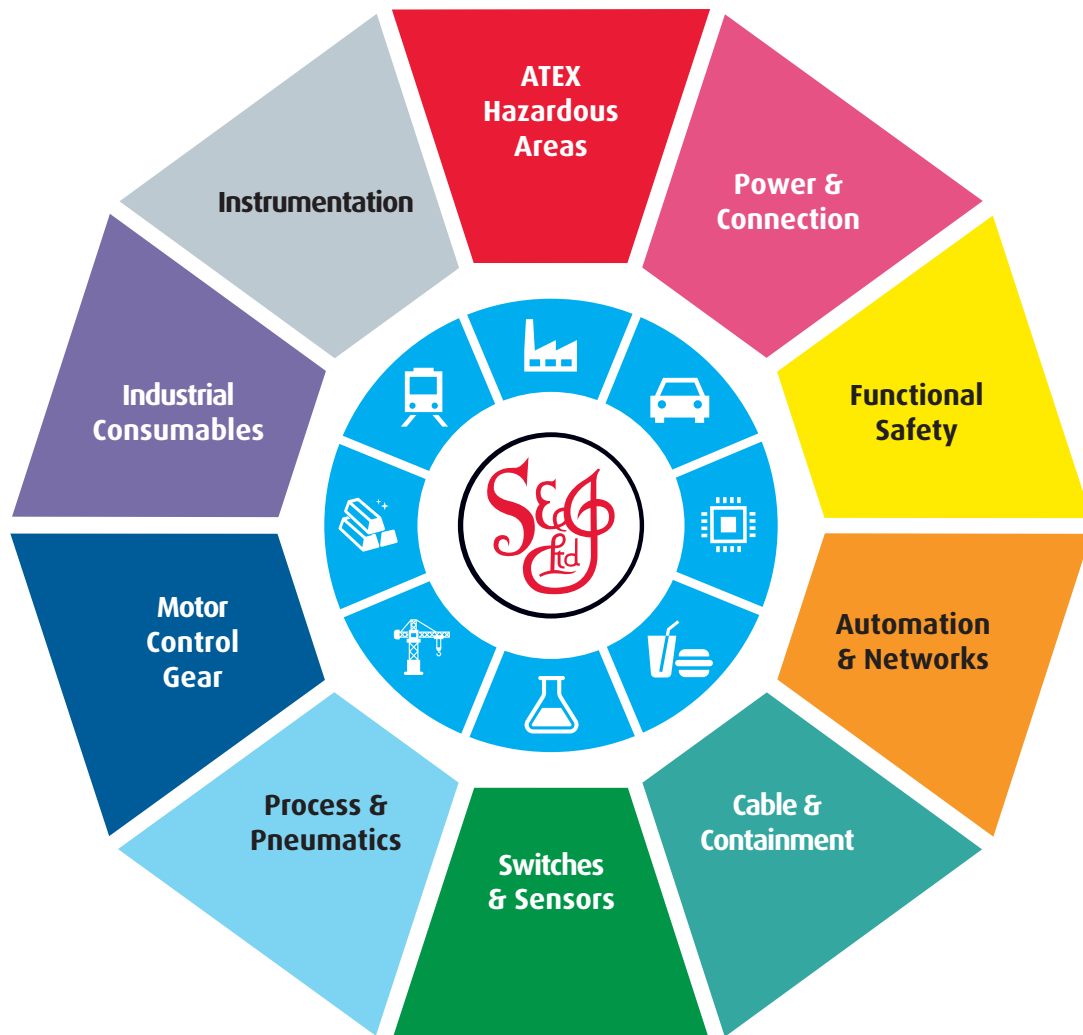

Online, In Branch and On the Road - Scattergood & Johnson Ltd, there when you need us.

www.scatts.co.uk