

**The easy access to
non-contact temperature
measurement:
Smart, safe and fast
from -50 to 1030 °C**

Features:

- Temperature range: -50 °C to 1030 °C
- Response time: 14 ms
- Optical Resolution: 15:1
- Green LED alarm indication, aiming support, selfdiagnostic or temperature code indication
- Usable up to 80 °C ambient temperature without cooling
- Several outputs selectable: 0–10 V or 0–5 V free scalable or thermocouple type K, alarm output or digital output
- Easy adjustment via IRmobile Android App and Windows software (CompactConnect)
- Power supply: 5–30 V DC



General Specifications

Environmental rating	IP 63
Ambient temperature	-20 °C ... 80 °C
Storage temperature	-40 °C ... 85 °C
Relative humidity	10–95 %, non condensing
Vibration	IEC 68-2-6: 3 G, 11–200 Hz, any axis
Shock	IEC 68-2-27: 50 G, 11 ms, any axis
Weight	58 g

Electrical Specifications

Output / analog	Selectable: 0–5 V or 0–10 V free scalable or thermocouple type K/ alarm with adjustable voltage levels
Output / alarm	0–30 V/ 50 mA (open collector)
3-state alarm output	Adjustable threshold values and voltage level for: no alarm, pre-alarm, alarm
Output / digital	Uni/ bidirectional, 9,6 / 115,2 kBaud (adjustable via software), 0/3 V digital level/ USB optional
Input (0–10 V)	Programmable functional input for external emissivity setting/ambient temperature adjustment, triggered signal output or peak-hold function
LED-functions	Alarm indication, automatic aiming support, self diagnostic, temperature indication (via. temp.code)
Cable length	1 m (standard), 3 m, 8 m, 15 m
Power supply	5–30 V DC
Current draw	4 mA (without LED) / 10 mA

Measurement Specifications

Temperature range (scalable via software)	-50 °C ... 1030 °C
Spectral range	8 - 14 μm
Optical resolution (90 % energy)	15:1
CF-lens (optional)	0,8 mm @ 10 mm
System accuracy (at ambient temp. 23 ±5 °C)	±1,5 % or ±1,5 °C ¹⁾
Repeatability (at ambient temp. 23 ±5 °C)	±0,75 % or ±0,75 °C ¹⁾
Temperature coefficient	±0,05 K/K or ±0,05 % / K ²⁾
NETD	50 mK ³⁾
Response time (90 %)	14 ms (adjustable up to 999 s)
Emissivity/Gain (adjustable via 0–10 V DC input or software)	0,100–1,100
Transmissivity (adjustable via software)	0,100–1,100
Signal processing (parameter adjustable via software)	Peak hold, valley hold, average; extended hold function with threshold and hysteresis
Software / App	optris CompactConnect / IRmobile

¹⁾ Object temperature > 0 °C ; whichever is greater

²⁾ For ambient temperatures <18 °C and >28 °C; whichever is greater

³⁾ At time constant 200 ms and $T_{obj} 200 °C$

optris CS LT

Optical Specifications

Optics, D:S = 15:1

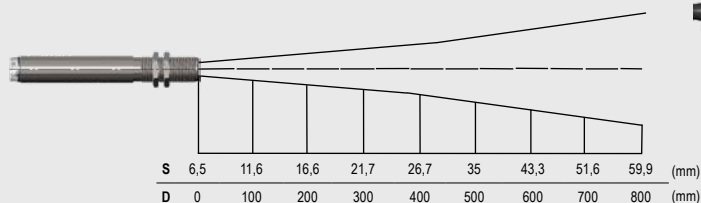

Optics with CF-lens, D:S = 15:1

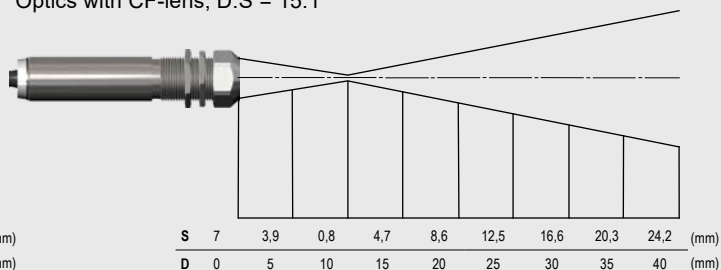

Connections

Connection analog with open collector alarm output (e.g. to actuate a relay)

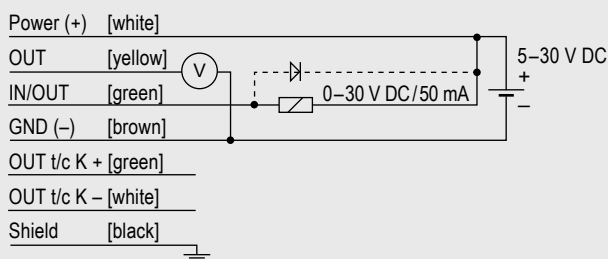

The CS LT can be connected to a smartphone via the IR app connector.



Connection digital with the optional IR app connector

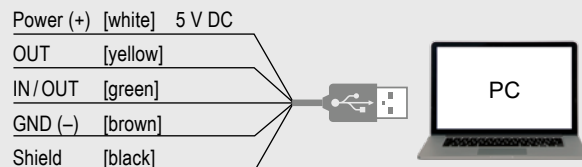

Dimensions / Accessories (examples)

Dimensions optris CS

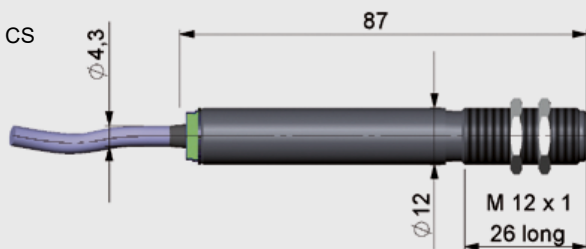

CF-lens (ACCTCF)

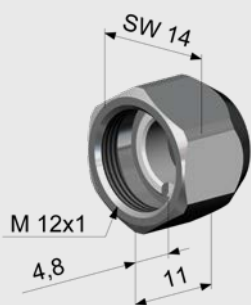

Mounting bracket, fixed (ACCTFB)

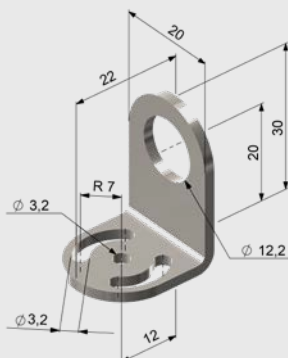

Air purge collar, optional with integrated CF-lens (ACCTAPLCF)

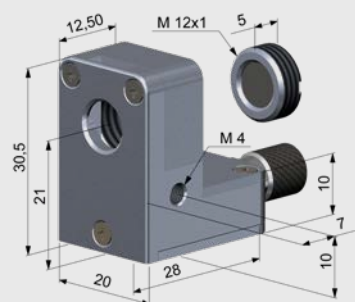



SCATTERGOOD & JOHNSON LTD

ELECTRICAL ENGINEERING & FLUID CONTROL DISTRIBUTORS

Est.1899

At Scattergood & Johnson Ltd, we pride ourselves on being a technical distributor to specialist industries.

Working with a range of quality product manufacturers across a number of specialist markets, we are not your average 'box shifter' - we are your technical and supply chain partner.

We fully support every product we sell - for free! Our internal team and external sales engineers can answer any product or application question, no matter the complexity.

Backing up this technical ability is a range of 50,000+ products available from stock for nationwide next day delivery (same day if required!), or you can collect what you need from any of our trade counters around the UK.

Select your specialist interest below to learn more about how we can help.



Online, In Branch and On the Road - Scattergood & Johnson Ltd, there when you need us.

www.scatts.co.uk