



INXPECT SAFETY RADAR EQUIPMENT

Product catalogue

INXPECT SAFETY RADAR EQUIPMENT

Industrial safety at its best: Inxpect safety radars detect access or presence of operators in dangerous areas and also have the ability to dynamically set the detection and warning zones.

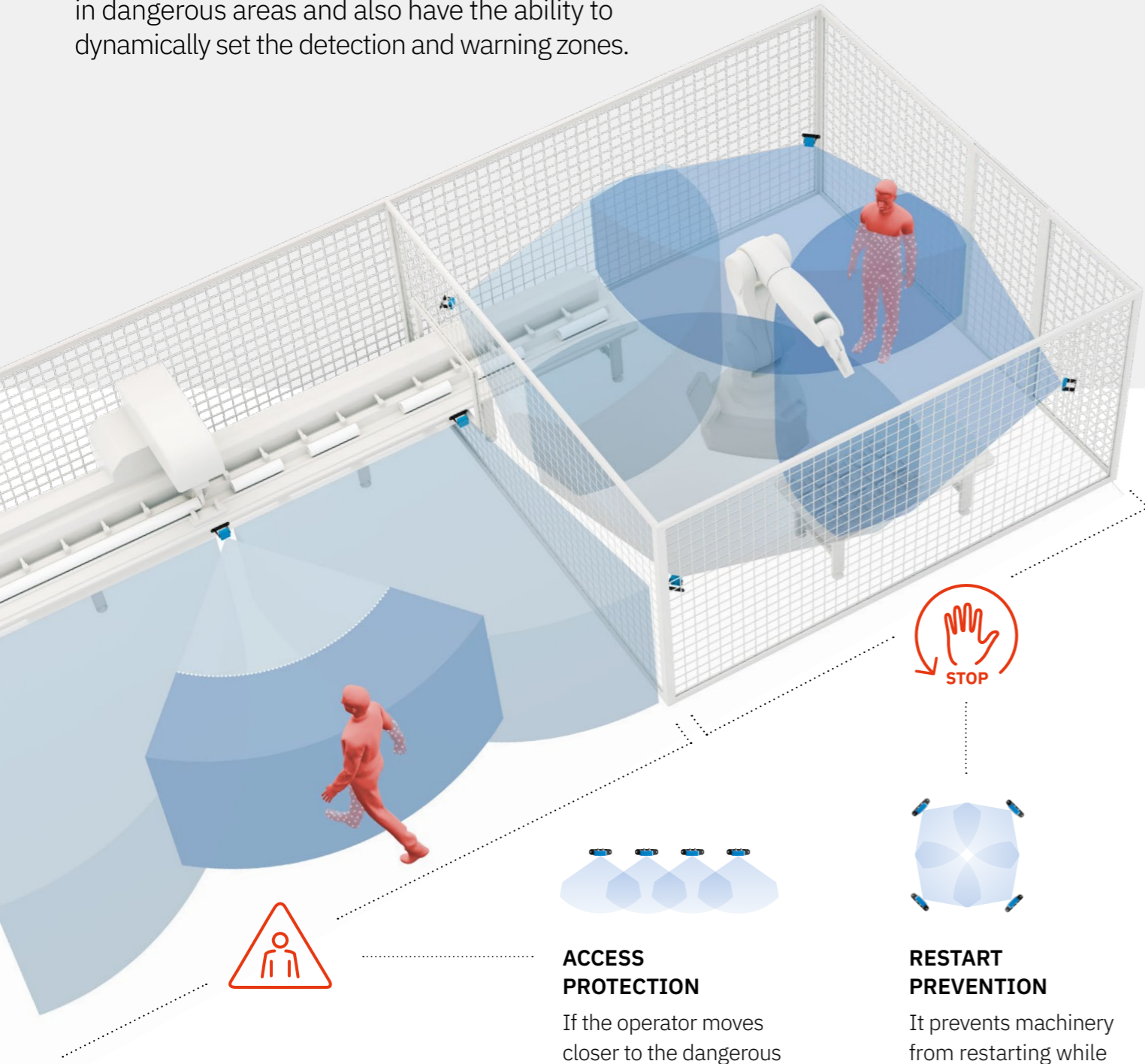

ACCESS PROTECTION

If the operator moves closer to the dangerous area, it places machinery in a safe state.



RESTART PREVENTION

It prevents machinery from restarting while operators are in the dangerous area.

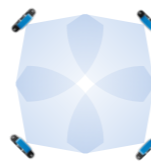
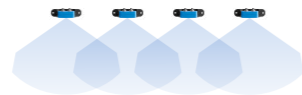

WORLD'S FIRST
SIL2/PLd and UL Listed safety radar products

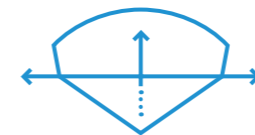

DYNAMIC MODIFICATION OF DETECTION ZONES

The sensor parameters can be configured in real-time, allowing a dynamic modification of the detection zone. This feature makes Inxpect sensors perfect solutions for mobile robotic applications.



IMPROVE THE COMMUNICATION WITH MACHINERY

The modular fieldbus allows Inxpect Smart Sensors to exchange safety data, such as the position of the target, in real time with the machinery's PLC. This allows an effective integration with the machinery's control system.



SECURE CONFIGURATION

Whether you chose USB or Ethernet for configuring Inxpect Safety Radar Products, we got you covered. In all cases, Inxpect control units and the Inxpect Safety Application cooperate in full security.

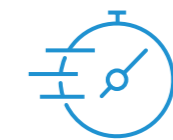

RESPONSE TIME < 100 ms

With response times lower than 100 ms, you can save space and reduce the area required to stop the machinery.

LIGHT



RESISTANT TO DISTURBANCES

Optical devices often fail due to dust, smoke, water or waste generated by the production process. The Inxpect team, highly specialized in radar technology, has developed a sophisticated long range radar algorithm that filters out those disturbances, reducing false alarms and increasing productivity.

SMOKE



Inxpect Smart Sensors are immune not only to **light**, **smoke** and **debris**, but also to **rain** (rainfall rate up to 45 mm/h).



Inxpect works where optical sensors stop.
High safety without compromising productivity.

DEBRIS



FLUIDS



“ Inxpect is a young tech company with an extraordinary team and corporate culture, which have allowed the company to develop the most advanced safety radar in the world ”

Passion is what guides our team, a passion that continues to grow from month to month: that is the driving force that makes anything possible, and that made Inxpect the first company in the world (and the only one to date) to create a SIL-certified safety radar system.

We have in-depth knowledge of the global safety market. We know all of its demands and secrets. We know what different industries need and we are here to change the idea of safety from how it is perceived today to bring it to a totally new level. Inxpect is an international company with offices in Italy, Spain, Germany, North America, China and with future plans to have a direct presence in many other countries.

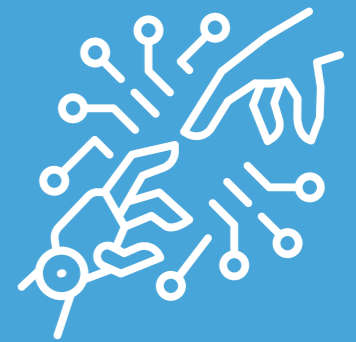

25+
 millions euro raised

6000+
 working installations

22+
 active patents families

20+
 PhDs in core R&D

15+
 worldwide partnership in safety and robotics



Software

Inxpect Safety Application

The software allows simple and intuitive configuration and subsequent validation of the coverage area. The Inxpect Safety App is a software application that can be installed on any PC or Mac, and that guides users to the configuration of the volumetric coverage areas of Inxpect safety radar systems, the I/O interfaces configuration and system parameters setting, and to the validation process. It is an integral part of all Inxpect safety systems.

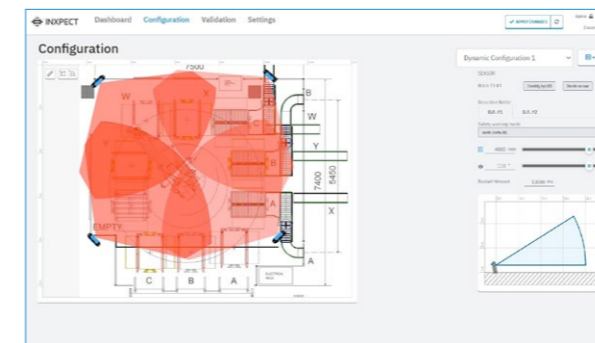

1 SYSTEM CONFIGURATION
Easily set up all sensor and control unit parameters, as well as import machinery layouts in different formats.

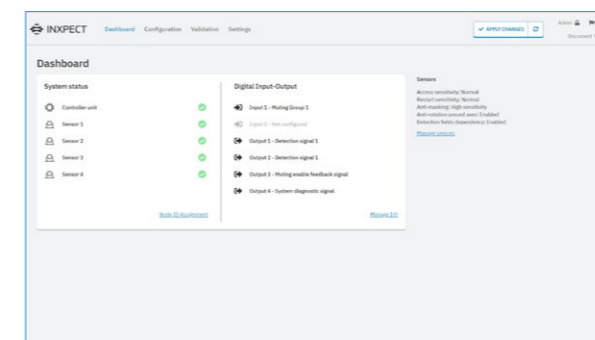

2 SYSTEM STATUS CHECK
Reporting of the status of the control unit and single sensors, outputs and inputs.

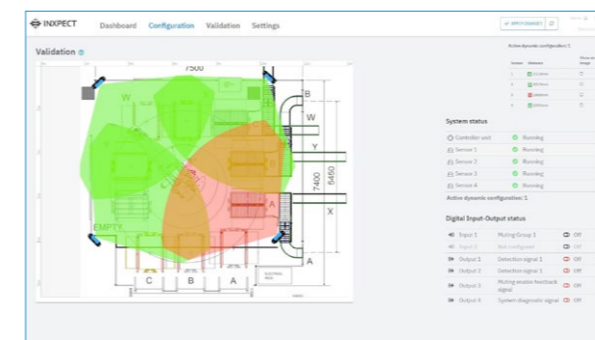

3 SYSTEM VALIDATION
The Inxpect Safety App guides users through the validation of the system and the production of validation reports.

INXPECT SAFETY APPLICATION



INXPECT CONTROL UNIT

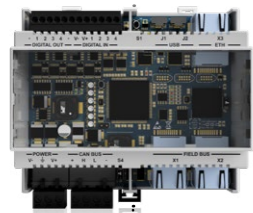

INXPECT SMART RADAR SENSORS

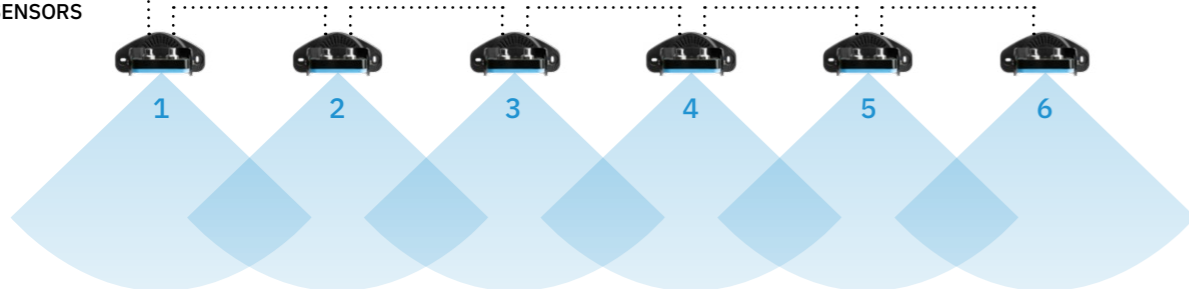

Inxpect Safety Radar Equipment

is flexible, modular and scalable

Inxpect Safety Radar systems are composed of a **control unit** and up to six **smart radar** sensors: high flexibility, from simple to complex scenarios.

Configuring the system is quick and easy, thanks to the user friendly **Inxpect Safety Application**.

Guided validation procedures and the simple generation of the configuration report complete each installation.



Target information as distance and angle are always available in real time.



The Inxpect Safety Application allows to set up to 32 different configurations to be selected dynamically in real time.



Programmable Muting function: the configuration of sensor groups that can be temporarily muted allows operators to safely access parts of the dangerous area, according to production needs.

Restart Prevention

Inxpect radar sensors are designed to monitor the presence of people in the area and, at the same time, filter out static objects (these objects do not stop the machine).



Static objects in the area are filtered out. The robot restarts and continues its operating cycle.

S200 sensors introduce Restart Prevention with Static Object Detection

When needed, an additional function can be activated: **Static Object Detection**.

This feature allows you to detect even static objects in the area keeping the machine in stop. It is particularly important to avoid collision with potential obstacles in mobile applications such as overhead gantries, AGVs, self-driving vehicles, etc.



When Static Object Detection is active and there are obstacles in the area the system prevents the restart of the machine.

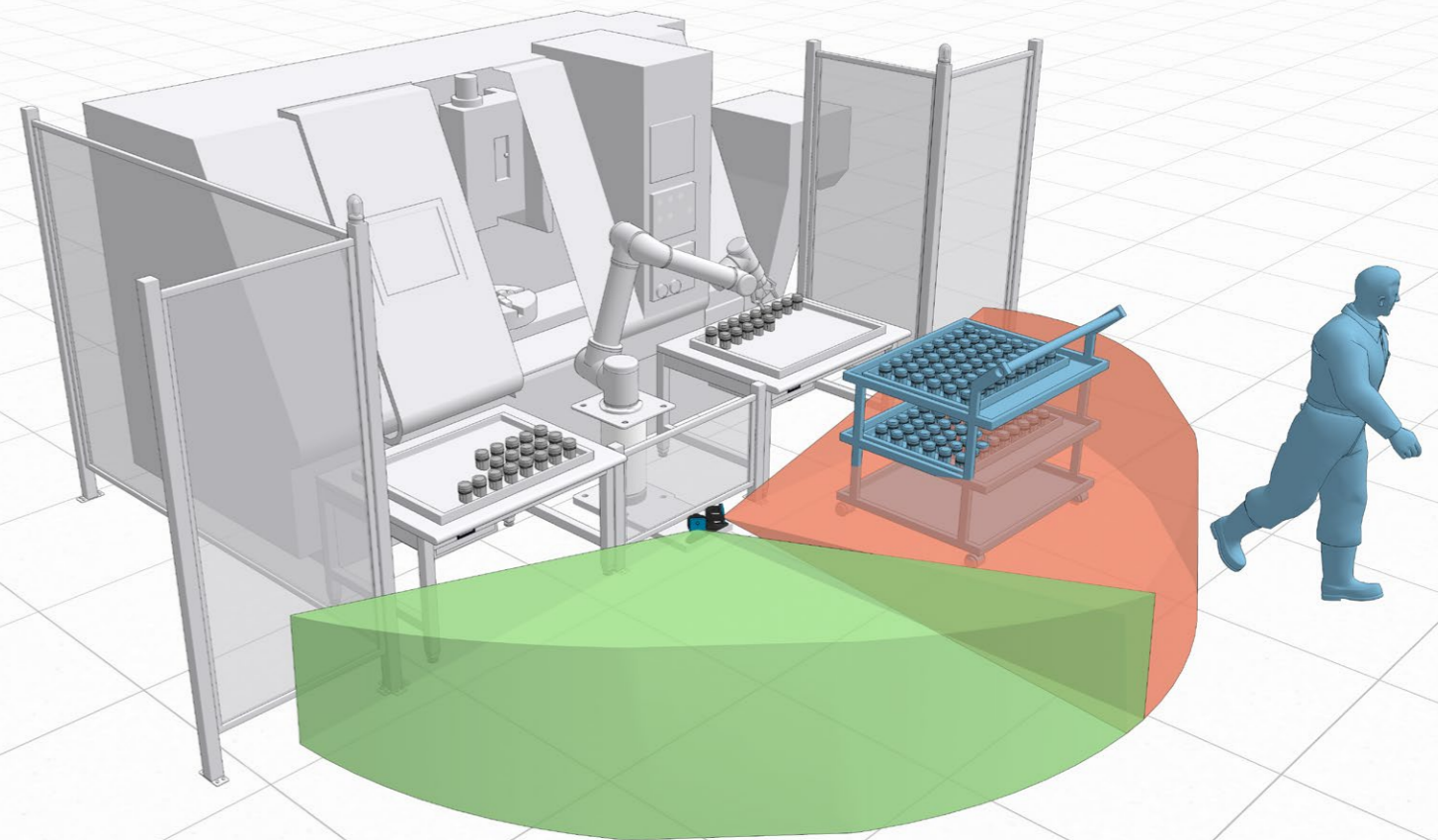
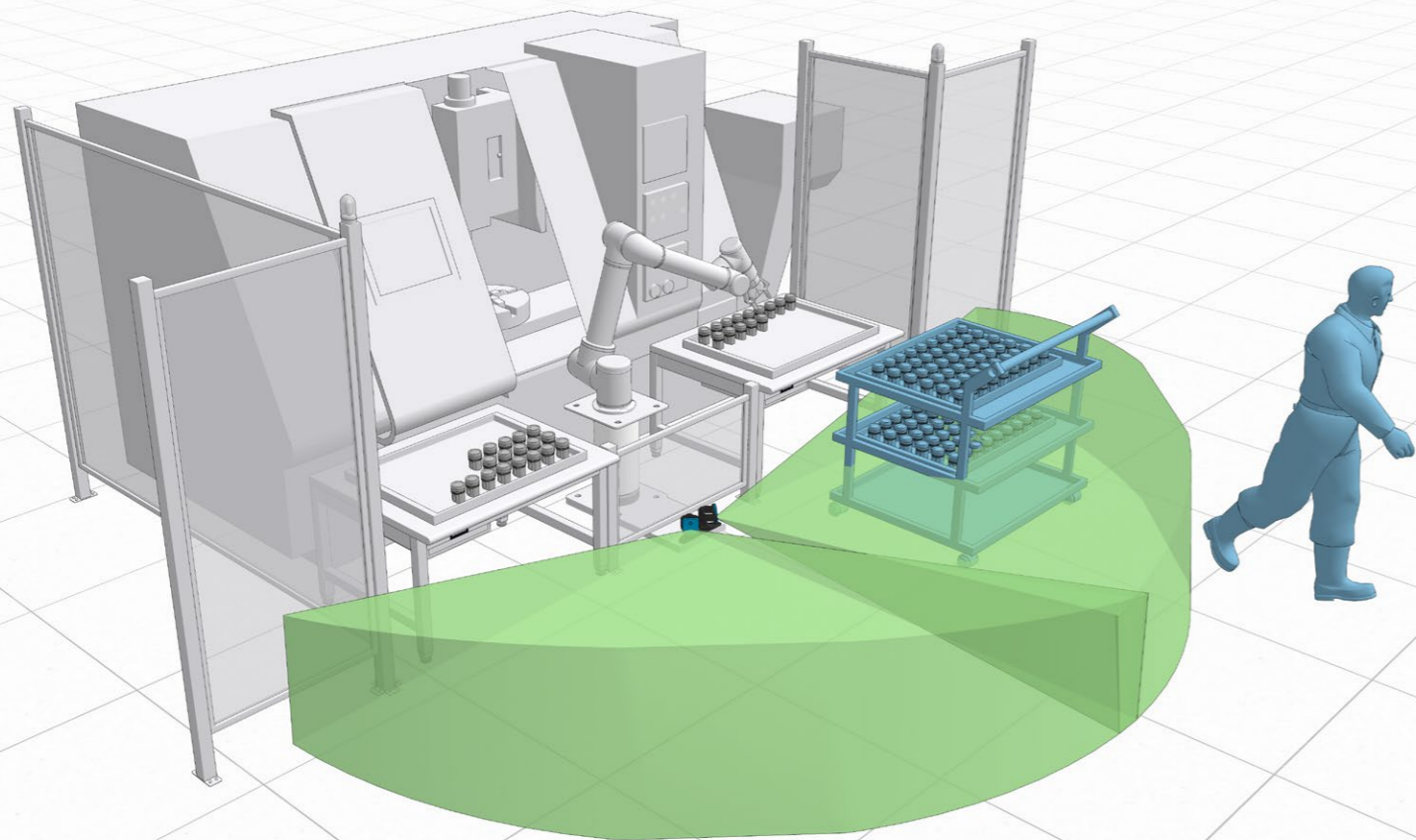



SMART SENSORS









S101A

S203A-W

Which smart sensor fits my needs?

SMART SENSORS

Technical specifications

		Vertical angular coverage	FOV	Max target speed	Min settable distance	Settable RCS
4M RANGE	 S101A	Wide 30° Narrow 15°	Symmetrical	1,6 m/s	1 m	-
	 S201A	20°	Symmetrical	2 m/s	0.5 m	-
5M RANGE	 S201A-W	20°	Advanced	2 m/s	0.2 m	-
	 S203A-W	12°	Advanced	2 m/s	0.2 m	-
	 S201A-MLR	20°	Symmetrical	4 m/s	0.5 m	✓
9M RANGE	 S201A-WL	20°	Advanced	4 m/s	0.2 m	✓
	 S203A-WL	12°	Advanced	4 m/s	0.2 m	✓

S101A

S101A

The first safety radar sensor

The **S101A** sensor is a smart FMCW (Frequency Modulated Continuous Wave) radar device based on proprietary Inxpect detection algorithms. The sensor sends 24 GHz radio waves and recovers motion information, analyzing the signals reflected by both static and moving objects in the operative range.

The sensors perform the following primary functions:

- **Motion and scenario analysis.**
- **Communication to the control unit of processed motion data and diagnostic information.**

Two detection fields with fixed angles (angles can only be wide or narrow).

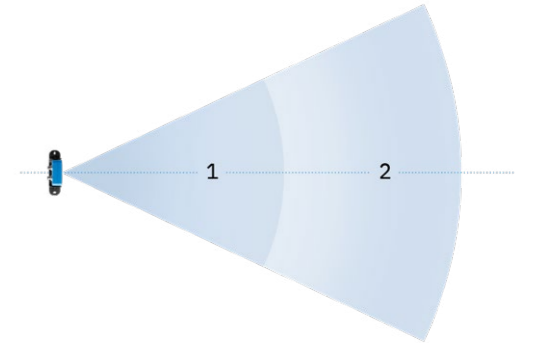

Two configurable fields of view

1. Narrow FOV 0 - 4m [min. set distance: 1m]
Horizontal Plane: 50°
Vertical Plane: 15°

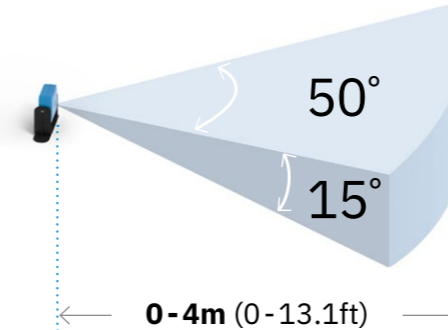

2. Wide FOV 0 - 4m [min. set distance: 1m]
Horizontal Plane: 110°
Vertical Plane: 30°

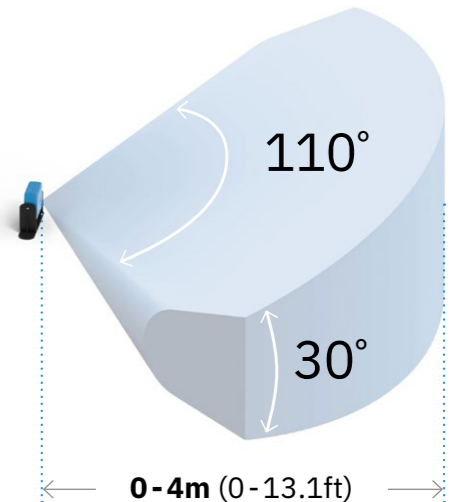

Scan the QR Code to open the Regulatory Notice Page



Smart Sensor 100 SERIES

The first safety radar sensor



- Safety Parameters:**
- SIL2 (IEC 61508)
 - PLd, Cat. 2 (ISO 13849)

Part No. **90202011**

4m Range sensor
10s Restart timeout
1.6m/s Max target speed

Technical details

Frequency	24 GHz ISM license-free
Connectors	Two 5-pin M12 connectors (1 male and 1 female)
CAN bus termination resistance	120 Ω (not supplied, to be installed with termination connector)
Power supply	12 V dc ± 20%, through control unit
Power consumption	1.5 W
Degree of protection	IP67
Operating temperature	From -30 to +60 °C (-22 to +140 °F)
Case material	Sensor: PA66 Bracket: PA66 and glass fiber (GF)

S201A

S201A Symmetrical FOV

The **S201A** sensor is a smart FMCW (Frequency Modulated Continuous Wave) radar device based on proprietary Inxpect detection algorithms. Operating in the millimeter wave V band (60 GHz), it can detect complex scenes by analyzing the returned signals reflected by both static and moving objects in the operative range. With dynamically selectable horizontal field of view and up to four safety areas, it is ideal for complex application scenarios, including mobile use cases.

Four independent detection fields with freely adjustable angles (10°-100°) and a maximum total distance of 5 m.

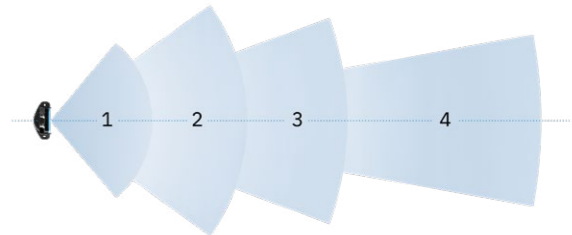

The aperture of each field is dynamically adjustable in 10° increments over a range of 10° to 100°.

The sensors perform the following primary functions:

- **Motion and scenario analysis.**
- **Communication to the control unit of processed motion data and diagnostic information.**
- **Static Object Detection:** this new option allows to detect static objects in the area where the restart prevention safety function is activated. By doing so it prevents the machinery from restarting when there are obstacles in the area.

Field of view

0 - 5m [min. set distance: 0.5m]
Horizontal Plane: 10-100°
Vertical Plane: 20°

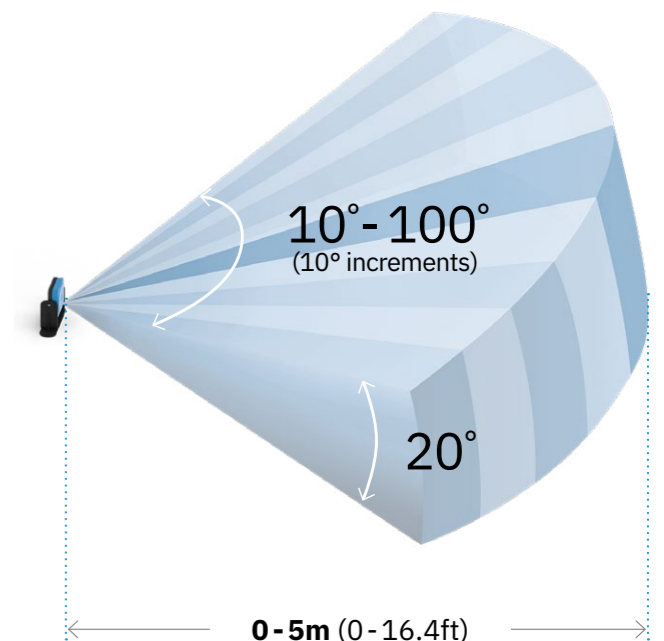

Scan the QR Code to open the Regulatory Notice Page



Smart Sensor 200 SERIES Symmetrical FOV

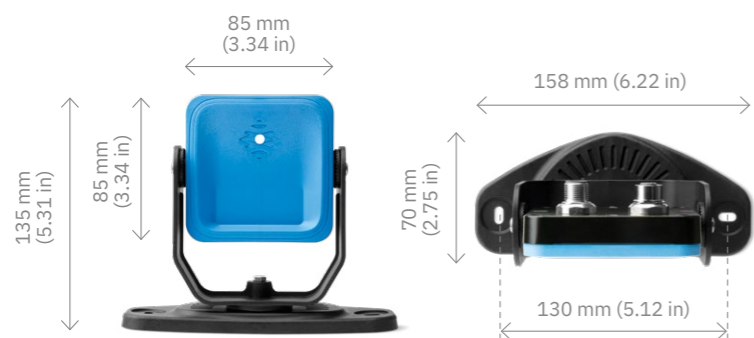

Safety Parameters:

- SIL2 (IEC 61508)
- PLd, Cat. 3 (ISO 13849)
- Performance Class D (IEC/TS 62998-1)

Part No. **90302011**

5m
Range sensor

4s
Restart timeout

2m/s
Max target speed

20°
Vertical plane

Technical details

Frequency	Millimeter waves V-band: 60 GHz
Connectors	Two 5-pin M12 connectors (1 male and 1 female)
CAN bus termination resistance	120 Ω (not supplied, to be installed with termination connector)
Power supply	12 V dc ± 20%, through control unit
Power consumption	2.2 W
Degree of protection	IP67
Operating temperature	From -30 to +60 °C (-22 to +140 °F)
Case material	Sensor: PA66 (front) + Aluminum (back) Bracket: PA66 and glass fiber (GF)

3-axes bracket: the sensor can rotate on three axes (x, y, z).





S201A-MLR

S201A-MLR

Symmetrical FOV, 9m range

The **S201A-MLR** sensor operates in the millimeter wave V band (60 GHz) and it can detect complex scenes by analyzing the returned signals reflected by both static and moving objects in the operative range.

In addition to the dynamically selectable horizontal field of view and up to four alarm areas, S201A-MLR also supports higher speeds (4 m/s) and longer ranges (9 meters) than the base S201A model. The **S201A-MLR** is therefore ideal in sectors like earth moving, railway, mining and agriculture.

The sensors perform the following primary functions:

- **Motion and scenario analysis.**
- **Communication to the control unit of processed motion data and diagnostic information.**
- **The RCS of the target can be selected for human safety or collision with other object. The custom target detection is a safety function that allows detecting the access of one or more objects with specific RCS values.**

Field of view

0 - 5m [min. set distance: 0.5m]

Horizontal Plane: 10-100°

Vertical Plane: 20°

5 - 9m

Horizontal Plane: 10-40°

Vertical Plane: 20°

Four independent detection fields with freely adjustable angles (see below) and a maximum total distance of 9 m.

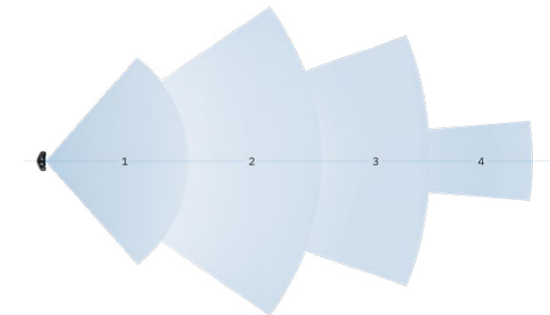

The aperture of each field is dynamically adjustable in 10° increments over a range of 10° to 100° (0-5 m) and over a range of 10° to 40° (5-9 m).

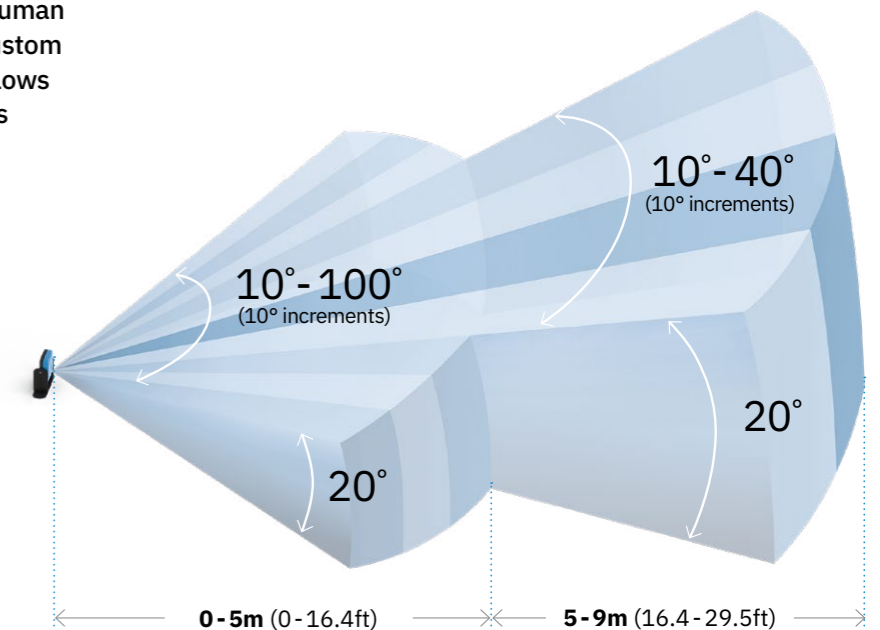

Scan the QR Code to open the Regulatory Notice Page



Smart Sensor 200 SERIES

Symmetrical FOV, 9m range



Safety Parameters:

- SIL2 (IEC 61508)
- PLd, Cat. 3 (ISO 13849)
- Performance Class D (IEC/TS 62998-1)

Part No. **90305010**

9m
Range sensor

4s
Restart timeout

4m/s
Max target speed

20°
Vertical plane

RCS
Selectable

Technical details

Frequency	Millimeter waves V-band: 60 GHz
Connectors	Two 5-pin M12 connectors (1 male and 1 female)
CAN bus termination resistance	120 Ω (not supplied, to be installed with termination connector)
Power supply	12 V dc ± 20%, through control unit
Power consumption	2.2 W
Degree of protection	IP67
Operating temperature	From -30 to +60 °C (-22 to +140 °F)
Case material	Sensor: PA66 (front) + Aluminum (back) Bracket: PA66 and glass fiber (GF)

3-axes bracket: the sensor can rotate on three axes (x, y, z).



S201A-W



Scan the QR Code to open the Regulatory Notice Page



Smart Sensor 200 SERIES Advanced FOV



Safety Parameters:

- SIL2 (IEC 61508)
- PLd, Cat. 3 (ISO 13849)
- Performance Class D (IEC/TS 62998-1)

S201A-W

Advanced FOV

The **NEW S201A-W** sensor has advanced field of view, i.e. the user can choose whether to use a symmetrical FOV, an asymmetrical FOV (asymmetric angles with respect to the central axis of the sensor) or a corridor FOV (with the sides cut off where required by the application). More and more modularity for all industrial applications!

The sensors perform the following primary functions:

- **Motion and scenario analysis.**
- **Communication to the control unit of processed motion data and diagnostic information.**
- **Static Object Detection:** this new option allows to detect static objects in the area where the restart prevention safety function is activated. By doing so it prevents the machinery from restarting when there are obstacles in the area.

Field of view 0 - 5m [min. set distance: 0.2m]
Horizontal Plane: 10-100°
Vertical Plane: 20°

Asymmetrical FOV $\alpha: 0^\circ-50^\circ$ $\beta: 0^\circ-50^\circ$

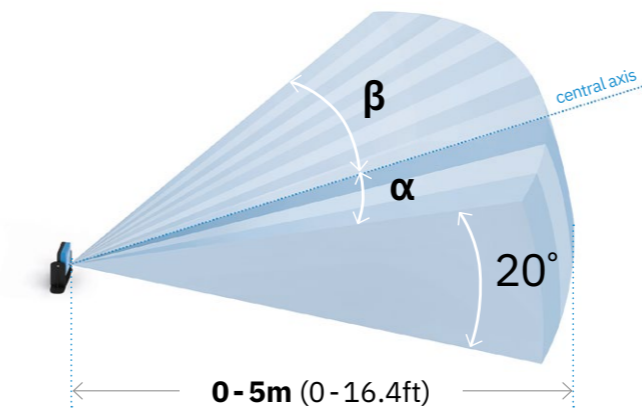

Four independent detection fields with freely adjustable angles (10°-100°) and a maximum total distance of 5 m.

Asymmetrical FOV $\alpha \neq \beta$

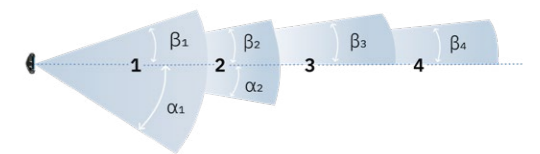

The aperture of each field is dynamically adjustable in 5° increments over a range of 10° to 100°.

Corridor FOV $\alpha = \beta = 50^\circ$

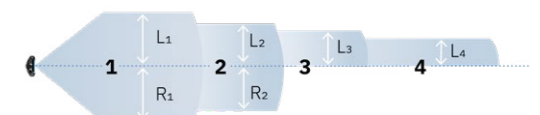

Corridor FOV $L + R \geq 20\text{cm}$

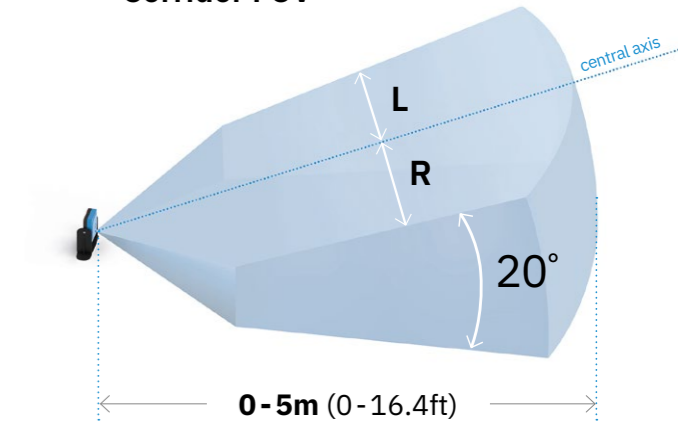

Part No. **90302111**

5m
Range sensor

4s
Restart timeout

2m/s
Max target speed

20°
Vertical plane

Technical details

Frequency	Millimeter waves V-band: 60 GHz
Connectors	Two 5-pin M12 connectors (1 male and 1 female)
CAN bus termination resistance	120 Ω (not supplied, to be installed with termination connector)
Power supply	12 V dc \pm 20%, through control unit
Power consumption	2.2 W
Degree of protection	IP67
Operating temperature	From -30 to +60 °C (-22 to +140 °F)
Case material	Sensor: PA66 (front) + Aluminum (back) Bracket: PA66 and glass fiber (GF)

3-axes bracket: the sensor can rotate on three axes (x, y, z).





S201A-WL



Scan the QR Code to open the Regulatory Notice Page



Smart Sensor 200 SERIES

Advanced FOV, 9m range

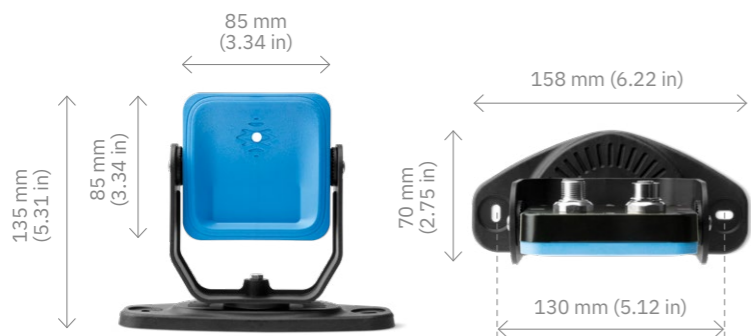

Safety Parameters:

- SIL2 (IEC 61508)
- PLd, Cat. 3 (ISO 13849)
- Performance Class D (IEC/TS 62998-1)

S201A-WL

Advanced FOV, 9m range

The **NEW S201A-WL** sensor, in addition to the advanced field of view (symmetrical, asymmetrical or corridor FOV), also supports higher speeds (4m/s) and longer ranges (9 meters) than the base S201A-W model. The **S201A-WL** is therefore ideal in sectors like earth moving, railway, mining and agriculture.

The sensors perform the following primary functions:

- **Motion and scenario analysis.**
- **Communication to the control unit of processed motion data and diagnostic information.**
- **The RCS of the target can be selected for human safety or collision with other object. The custom target detection is a safety function that allows detecting the access of one or more objects with specific RCS values.**

Field of view

0 - 5m [min. set distance: 0.2m] **5 - 9m**
 Horizontal Plane: 10-100° Horizontal Plane: 10-40°
 Vertical Plane: 20° Vertical Plane: 20°

Asymmetrical FOV [0-5m] α : 0°-50° β : 0°-50°
 [5-9m] α : 0°-20° β : 0°-20°

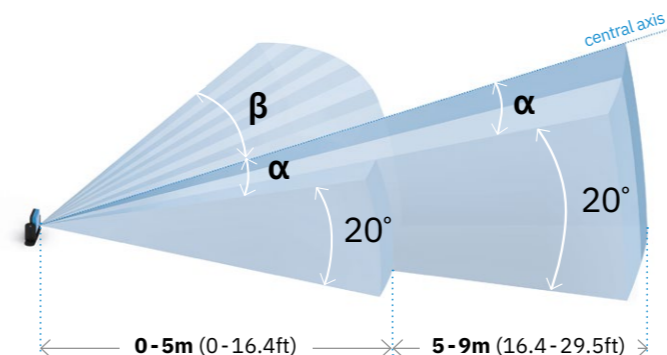

Corridor FOV [0-5m] $L + R \geq 20\text{cm}$
 [5-9m] $L + R \geq 30\text{cm}$

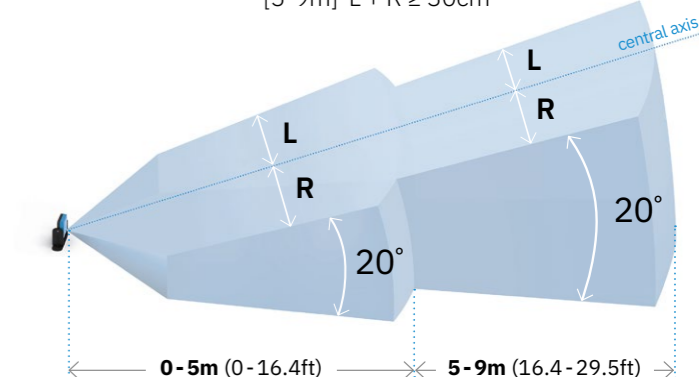

Four independent detection fields with freely adjustable angles (see below) and a maximum total distance of 9 m.

Asymmetrical FOV $\alpha \neq \beta$

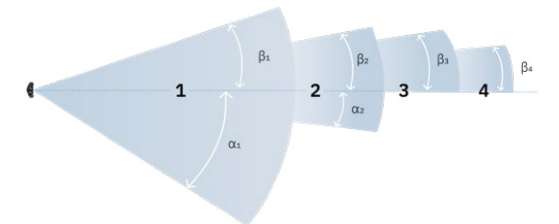

The aperture of each field is dynamically adjustable in 5° increments over a range of 10° to 100° (0-5 m) and over a range of 10° to 40° (5-9 m).

Corridor FOV $\alpha = \beta = 50^\circ$

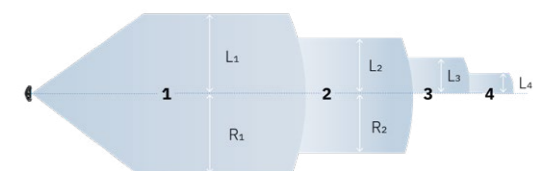

Part No. **90305111**

9m
Range sensor

4s
Restart timeout

4m/s
Max target speed

20°
Vertical plane

RCS
Selectable

Technical details

Frequency	Millimeter waves V-band: 60 GHz
Connectors	Two 5-pin M12 connectors (1 male and 1 female)
CAN bus termination resistance	120 Ω (not supplied, to be installed with termination connector)
Power supply	12 V dc \pm 20%, through control unit
Power consumption	2.2 W
Degree of protection	IP67
Operating temperature	From -30 to +60 °C (-22 to +140 °F)
Case material	Sensor: PA66 (front) + Aluminum (back) Bracket: PA66 and glass fiber (GF)

3-axes bracket: the sensor can rotate on three axes (x, y, z).



S203A-W

S203A-W Vertical FOV 12°

The **NEW S203A-W** has an advanced field of view equipped with a vertical angular coverage of only 12° (instead of 20° in previous sensors), making it the most adaptable sensor for Autonomous Guided Vehicles (AGVs).

The sensors perform the following primary functions:

- **Motion and scenario analysis.**
- **Communication to the control unit of processed motion data and diagnostic information.**
- **Static Object Detection: this new option allows to detect static objects in the area where the restart prevention safety function is activated. By doing so it prevents the machinery from restarting when there are obstacles in the area.**

Field of view 0 - 5m [min. set distance: 0.2m]
Horizontal Plane: 10-100°
Vertical Plane: 12°

Asymmetrical FOV $\alpha: 0^\circ-50^\circ$ $\beta: 0^\circ-50^\circ$

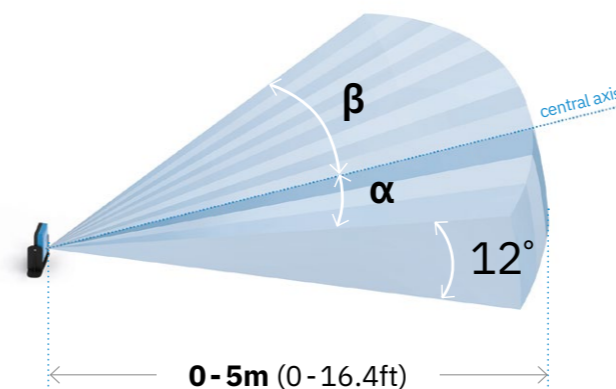

Four independent detection fields with freely adjustable angles (10°-100°) and a maximum total distance of 5 m.

Asymmetrical FOV $\alpha \neq \beta$

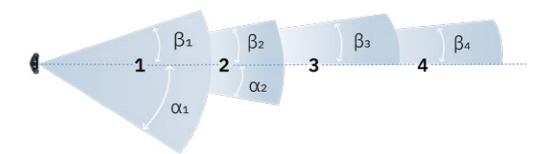

The aperture of each field is dynamically adjustable in 5° increments over a range of 10° to 100°.

Corridor FOV $\alpha = \beta = 50^\circ$

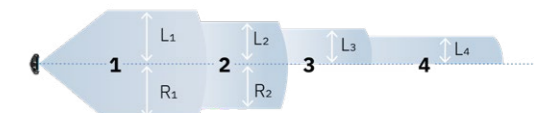

Corridor FOV $L + R \geq 20\text{cm}$

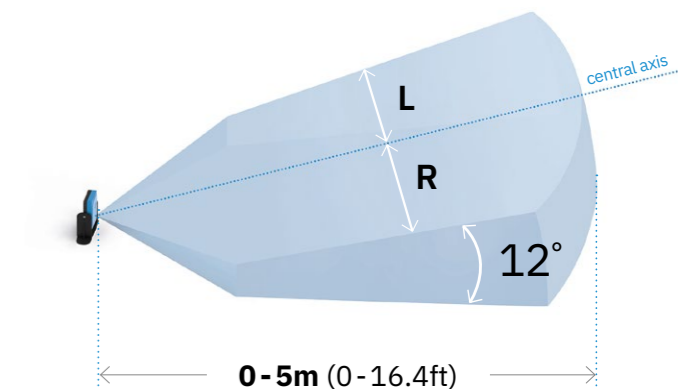

Smart Sensor 200 SERIES Vertical FOV 12°

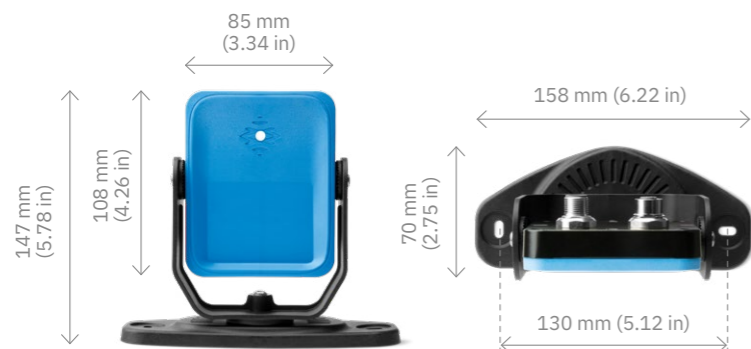

Safety Parameters:

- SIL2 (IEC 61508)
- PLd, Cat. 3 (ISO 13849)
- Performance Class D (IEC/TS 62998-1)

Part No. **90306011**

5m
Range sensor

4s
Restart timeout

2m/s
Max target speed

12°
Vertical plane

Technical details

Frequency	Millimeter waves V-band: 60 GHz
Connectors	Two 5-pin M12 connectors (1 male and 1 female)
CAN bus termination resistance	120 Ω (not supplied, to be installed with termination connector)
Power supply	12 V dc ± 20%, through control unit
Power consumption	2.2 W
Degree of protection	IP67
Operating temperature	From -30 to +60 °C (-22 to +140 °F)
Case material	Sensor: PA66 (front) + Aluminum (back) Bracket: PA66 and glass fiber (GF)

3-axes bracket: the sensor can rotate on three axes (x, y, z).



Scan the QR Code to open the Regulatory Notice Page





S203A-WL

S203A-WL Vertical FOV 12°, 9m range

The **NEW S203A-WL** sensor, in addition to the advanced field of view equipped with a vertical angular coverage of 12°, also supports higher speeds (4m/s) and longer ranges (9 meters) than the base S203A-W model. The **S203A-WL** is therefore ideal in sectors like earth moving, railway, mining and agriculture.

Four independent detection fields with freely adjustable angles (see below) and a maximum total distance of 9 m.

Asymmetrical FOV $\alpha \neq \beta$

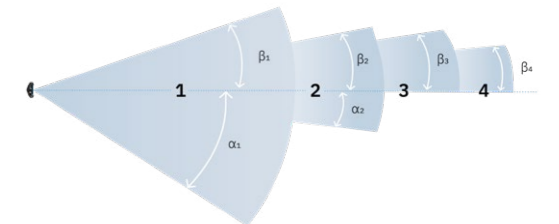

The aperture of each field is dynamically adjustable in 5° increments over a range of 10° to 100° (0-5 m) and over a range of 10° to 40° (5-9 m).

Corridor FOV $\alpha = \beta = 50^\circ$

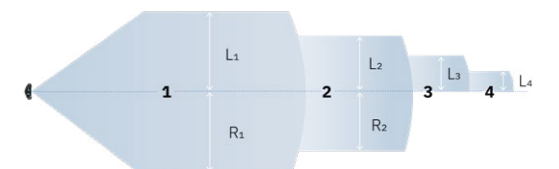

The sensors perform the following primary functions:

- **Motion and scenario analysis.**
- **Communication to the control unit of processed motion data and diagnostic information.**
- **The RCS of the target can be selected for human safety or collision with other object. The custom target detection is a safety function that allows detecting the access of one or more objects with specific RCS values.**

Field of view

0 - 5m [min. set distance: 0.2m]	5 - 9m
Horizontal Plane: 10-100°	Horizontal Plane: 10-40°
Vertical Plane: 12°	Vertical Plane: 12°

Asymmetrical FOV [0-5m] α : 0°-50° β : 0°-50°
[5-9m] α : 0°-20° β : 0°-20°

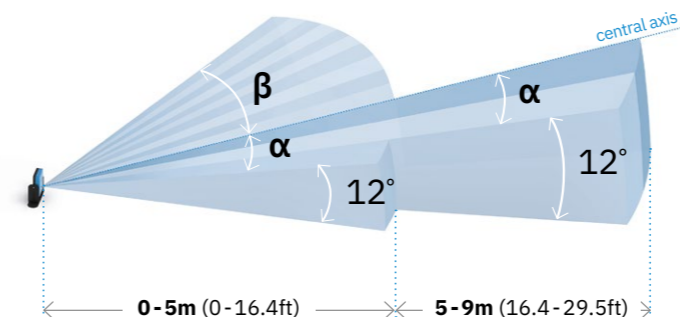

Corridor FOV [0-5m] $L + R \geq 20\text{cm}$
[5-9m] $L + R \geq 30\text{cm}$

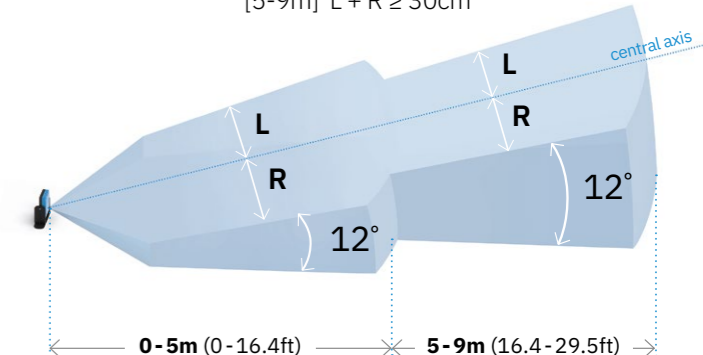

Scan the QR Code to open the Regulatory Notice Page



Smart Sensor 200 SERIES Vertical FOV 12°, 9m range



Safety Parameters:

- SIL2 (IEC 61508)
- PLd, Cat. 3 (ISO 13849)
- Performance Class D (IEC/TS 62998-1)

Part No. **90306111**

9m
Range sensor

4s
Restart timeout

4m/s
Max target speed

12°
Vertical plane

RCS
Selectable

Technical details

Frequency	Millimeter waves V-band: 60 GHz
Connectors	Two 5-pin M12 connectors (1 male and 1 female)
CAN bus termination resistance	120 Ω (not supplied, to be installed with termination connector)
Power supply	12 V dc \pm 20%, through control unit
Power consumption	2.2 W
Degree of protection	IP67
Operating temperature	From -30 to +60 °C (-22 to +140 °F)
Case material	Sensor: PA66 (front) + Aluminum (back) Bracket: PA66 and glass fiber (GF)

3-axes bracket: the sensor can rotate on three axes (x, y, z).





CONTROL UNITS

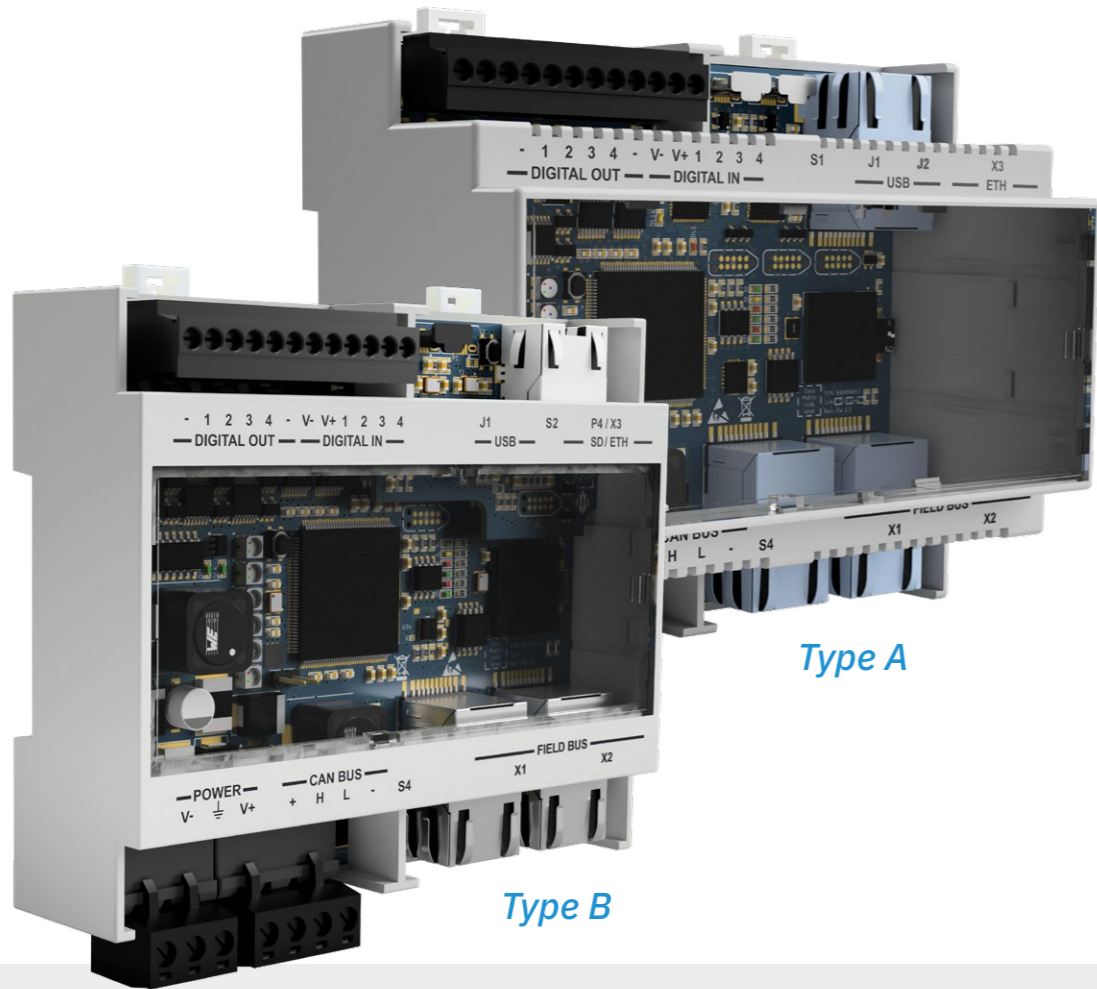









Type A

Type B

Which control unit fits my needs?

CONTROL UNITS

Technical specifications

	Fieldbus	Digital I/O	SD backup SD restore	Configuration	Dynamic setting of detection fields
TYPE A	 C201A-PNS	PROFIsafe MODBUS	✓	-	Ethernet USB Up to 32 configurations switchable in real time
	 C201A-F	FSoE MODBUS	✓	-	Ethernet USB Up to 32 configurations switchable in real time
	 C202A	MODBUS	✓	-	Ethernet USB Up to 8 configurations switchable in real time* <small>*from FW 2.0.0 onwards</small>
	 C203A	-	✓	-	USB Up to 8 configurations switchable in real time* <small>*from FW 2.0.0 onwards</small>
TYPE B	 C201B-P	PROFIsafe MODBUS	✓	✓	Ethernet USB Up to 32 configurations switchable in real time
	 C201B-F	FSoE MODBUS	✓	✓	Ethernet USB Up to 32 configurations switchable in real time
	 C202B	MODBUS	✓	✓	Ethernet USB Up to 8 configurations switchable in real time
	 C203B	-	✓	✓	USB Up to 8 configurations switchable in real time



C201 PROFIsafe



Scan the QR Code to open the Regulatory Notice Page



C201A-PNS | C201B-P

PROFIsafe, Ethernet and digital I/O

C201 is the most advanced control unit for Inxpect safety radars, with the widest range of communication options. The Inxpect Safety Application allows the configuration of sensitivity levels, safety functions, size of detection fields, and the functionality of the I/O ports of the control unit.

Safety fieldbus
Currently supporting PROFIsafe fieldbus protocol.

Secure Ethernet
Remote configuration and management protected by industry standard cyber security protocols.

USB
Local configuration option.

Digital inputs
Two dual-channel inputs supporting the following functions:

- muting signal
- emergency stop signal
- restart signal

Four Output Signal Switching Devices
As safety outputs: two dual-channel safety OSSDs.
As auxiliary outputs: four auxiliary outputs, which can be configured as signal restart feedback, fault, muting status.

Dynamic setting of detection fields
The PROFIsafe connection allows to have up to 32 configurations switchable in real time.

SD backup, SD restore
Configurations and login credentials can be saved and restored via microSD card (only for **C201B-P**).

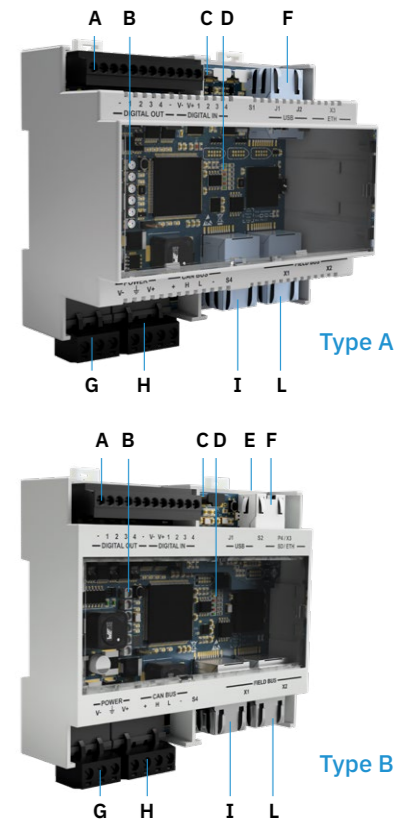

- A - I/O terminal block
- B - System status LED
- C - Micro USB port
- D - Fieldbus status LED
- E - SD card (only for **C201B-P**)
- F - Ethernet port
- G - Power supply terminal block
- H - CAN bus terminal block for connecting the first sensor
- I - Ethernet Fieldbus port n.1
- L - Ethernet Fieldbus port n.2

Control Unit 200 SERIES

PROFIsafe, Ethernet and digital I/O

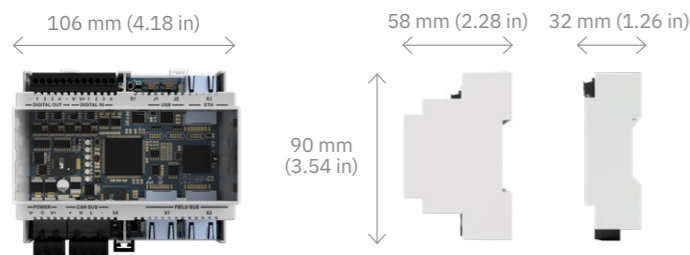

- Safety Parameters:**
- SIL2 (IEC 61508)
 - PLd, Cat. 3 (ISO 13849)
 - Performance Class D (IEC/TS 62998-1)



[A] Part No. **90301011**

[B] Part No. **90301111**

Technical details

Outputs	4 Outputs Signal Switching Devices (OSSDs) or 2 dual channel safety outputs
Safety outputs	High-side outputs (with extended protection function) Max voltage: 30 V dc Max current: 0.4 A Max power: 12 W
Inputs	2 dual channel TYPE3 digital inputs with common GND 4 single channel TYPE3 digital inputs with common GND [from FW 2.0.0 onwards]
Fieldbus interface	Ethernet based safety fieldbus (PROFIsafe)
MODBUS interface	Ethernet interface for real time data monitoring
Power supply	24 V dc (20–28 V dc) Max current: 1 A (no OSSD)
Max power consumption	5 W (no OSSD)
Assembly	DIN guide
Degree of protection	IP20
Terminals	Section: 1 mm ² Max Current: 4 A with 1 mm ² cables
System configuration	Ethernet, USB



C201 FSoE



Scan the QR Code to open the Regulatory Notice Page



C201A-F | C201B-F

FSoE, Ethernet and digital I/O

C201 is the most advanced control unit for Inxpect safety radars, with the widest range of communication options. The Inxpect Safety Application allows the configuration of sensitivity levels, safety functions, size of detection fields, and the functionality of the I/O ports of the control unit.

Safety fieldbus

Currently supporting Safety over EtherCAT® (FSoE) fieldbus protocol.

Secure Ethernet

Remote configuration and management protected by industry standard cyber security protocols.

USB

Local configuration option.

Digital inputs

Two dual-channel inputs supporting the following functions:

- muting signal
- emergency stop signal
- restart signal

Four Output Signal Switching Devices

As safety outputs: two dual-channel safety OSSDs.

As auxiliary outputs: four auxiliary outputs, which can be configured as signal restart feedback, fault, muting status.

Dynamic setting of detection fields

The FSoE connection allows to have up to 32 configurations switchable in real time.

SD backup, SD restore

Configurations and login credentials can be saved and restored via microSD card (only for **C201B-F**).

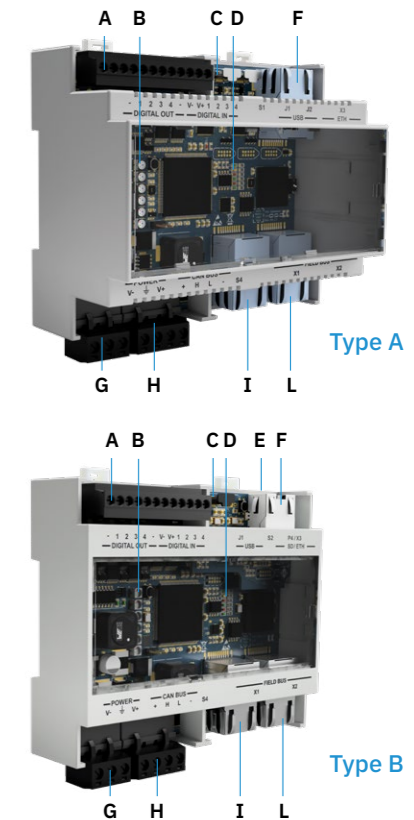

- A** - I/O terminal block
- B** - System status LED
- C** - Micro USB port
- D** - Fieldbus status LED
- E** - SD card (only for **C201B-F**)
- F** - Ethernet port
- G** - Power supply terminal block
- H** - CAN bus terminal block for connecting the first sensor
- I** - Ethernet Fieldbus port n.1
- L** - Ethernet Fieldbus port n.2

Control Unit 200 SERIES

FSoE, Ethernet and digital I/O

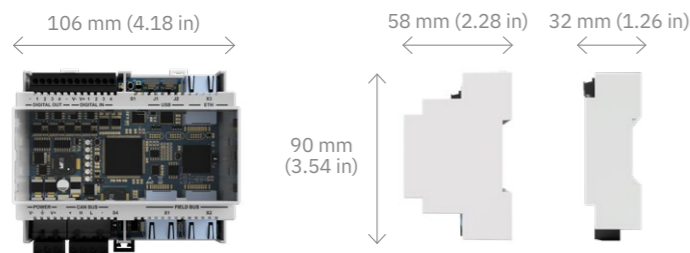

Safety Parameters:

- SIL2 (IEC 61508)
- PLd, Cat. 3 (ISO 13849)
- Performance Class D (IEC/TS 62998-1)

[A] Part No. **90301012**

[B] Part No. **90301112**



Technical details

Outputs	4 Outputs Signal Switching Devices (OSSDs) or 2 dual channel safety outputs
Safety outputs	High-side outputs (with extended protection function) Max voltage: 30 V dc Max current: 0.4 A Max power: 12 W
Inputs	2 dual channel TYPE3 digital inputs with common GND 4 single channel TYPE3 digital inputs with common GND [from FW 2.0.0 onwards]
Fieldbus interface	Ethernet based safety fieldbus (Safety over EtherCAT® FSoE)
MODBUS interface	Ethernet interface for real time data monitoring
Power supply	24 V dc (20–28 V dc) Max current: 1 A (no OSSD)
Max power consumption	5 W (no OSSD)
Assembly	DIN guide
Degree of protection	IP20
Terminals	Section: 1 mm ² Max Current: 4 A with 1 mm ² cables
System configuration	Ethernet, USB



C202 MODBUS



Scan the QR Code to open the Regulatory Notice Page

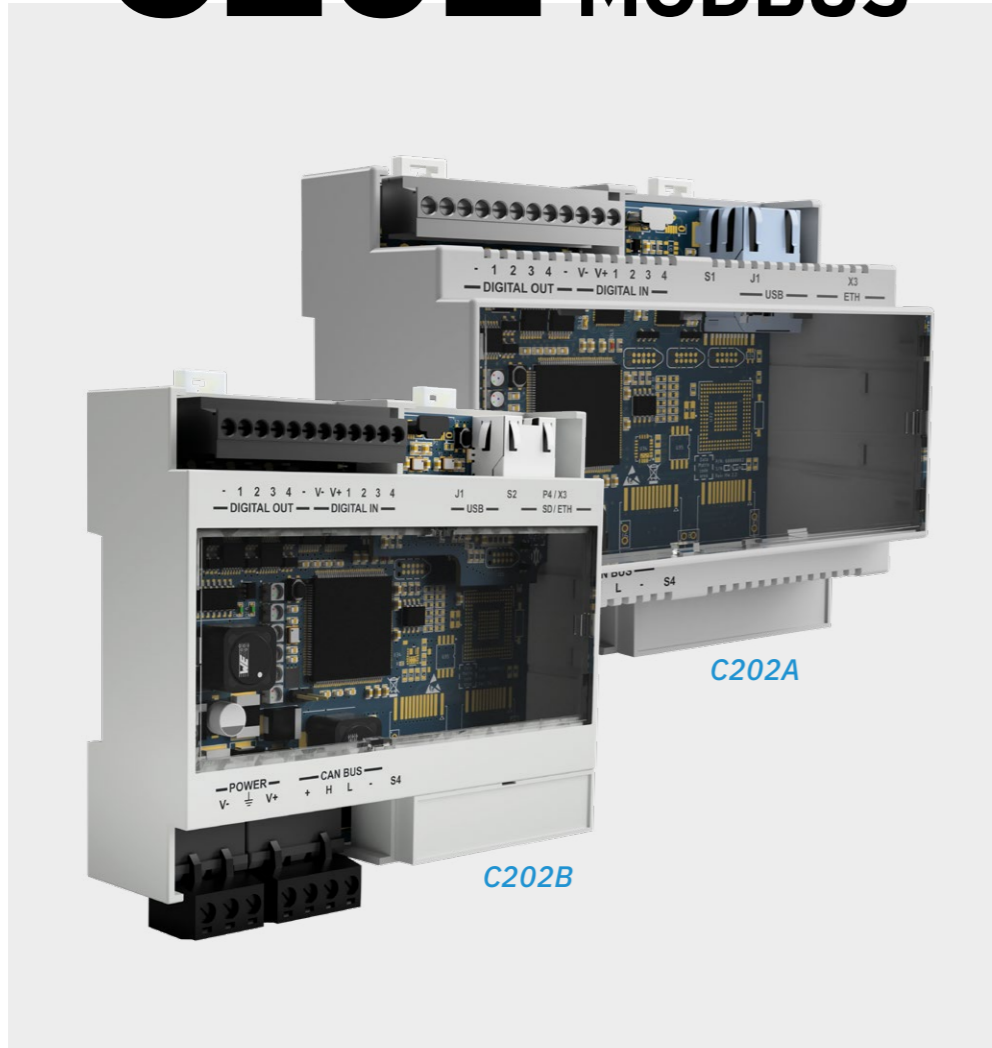

C202A | C202B

Ethernet and digital I/O

C202 offers both USB and Ethernet communication interfaces, providing local and remote configuration options. In both cases, the Inxpect Safety Application allows the configuration of sensitivity levels, safety functions, size of detection fields, and the functionality of the I/O ports of the control unit.

Secure Ethernet

Remote configuration and management protected by industry standard cyber security protocols.

USB

Local configuration option.

Digital inputs

Two dual-channel inputs supporting the following functions:

- muting signal
- emergency stop signal
- restart signal

Four Output Signal Switching Devices

As safety outputs: two dual-channel safety OSSDs.

As auxiliary outputs: four auxiliary outputs, which can be configured as signal restart feedback, fault, muting status.

Dynamic setting of detection fields

There are up to 8 configurations switchable in real time.

SD backup, SD restore

Configurations and login credentials can be saved and restored via microSD card (only for **C202B**).

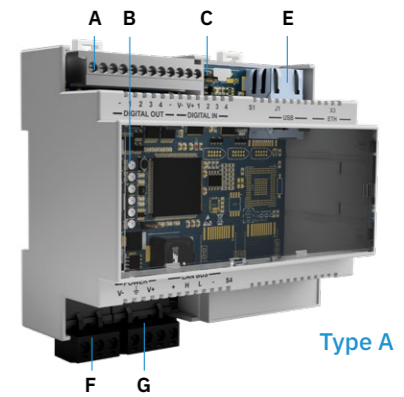

Type A

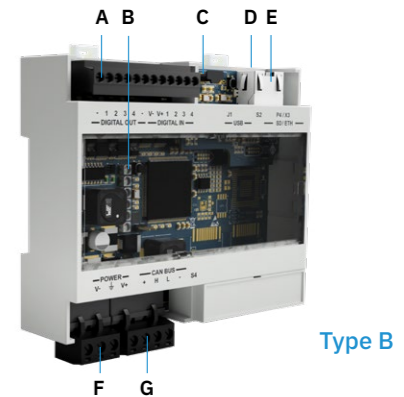

Type B

- A - I/O terminal block
- B - System status LED
- C - Micro USB port
- D - SD card (only for **C202B**)
- E - Ethernet port
- F - Power supply terminal block
- G - CAN bus terminal block for connecting the first sensor

Control Unit 200 SERIES

Ethernet and digital I/O

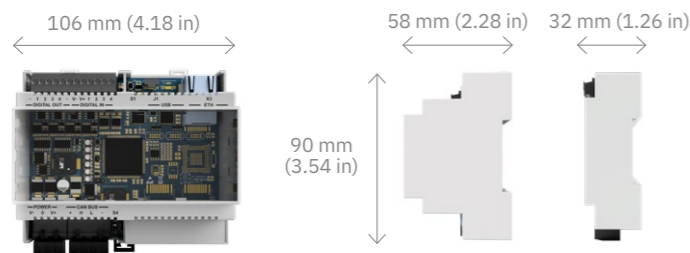

Safety Parameters:

- SIL2 (IEC 61508)
- PLd, Cat. 3 (ISO 13849)
- Performance Class D (IEC/TS 62998-1)

[A] Part No. **90303011**

[B] Part No. **90303111**

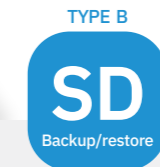

Technical details

Outputs	4 Outputs Signal Switching Devices (OSSDs) or 2 dual channel safety outputs
Safety outputs	High-side outputs (with extended protection function) Max voltage: 30 V dc Max current: 0.4 A Max power: 12 W
Inputs	2 dual channel TYPE3 digital inputs with common GND 4 single channel TYPE3 digital inputs with common GND [from FW 2.0.0 onwards]
MODBUS interface	Ethernet interface for real time data monitoring
Power supply	24 V dc (20–28 V dc) Max current: 1 A (no OSSD)
Max power consumption	5 W (no OSSD)
Assembly	DIN guide
Degree of protection	IP20
Terminals	Section: 1 mm ² Max Current: 4 A with 1 mm ² cables
System configuration	Ethernet, USB



C203 USB



Scan the QR Code to open the Regulatory Notice Page

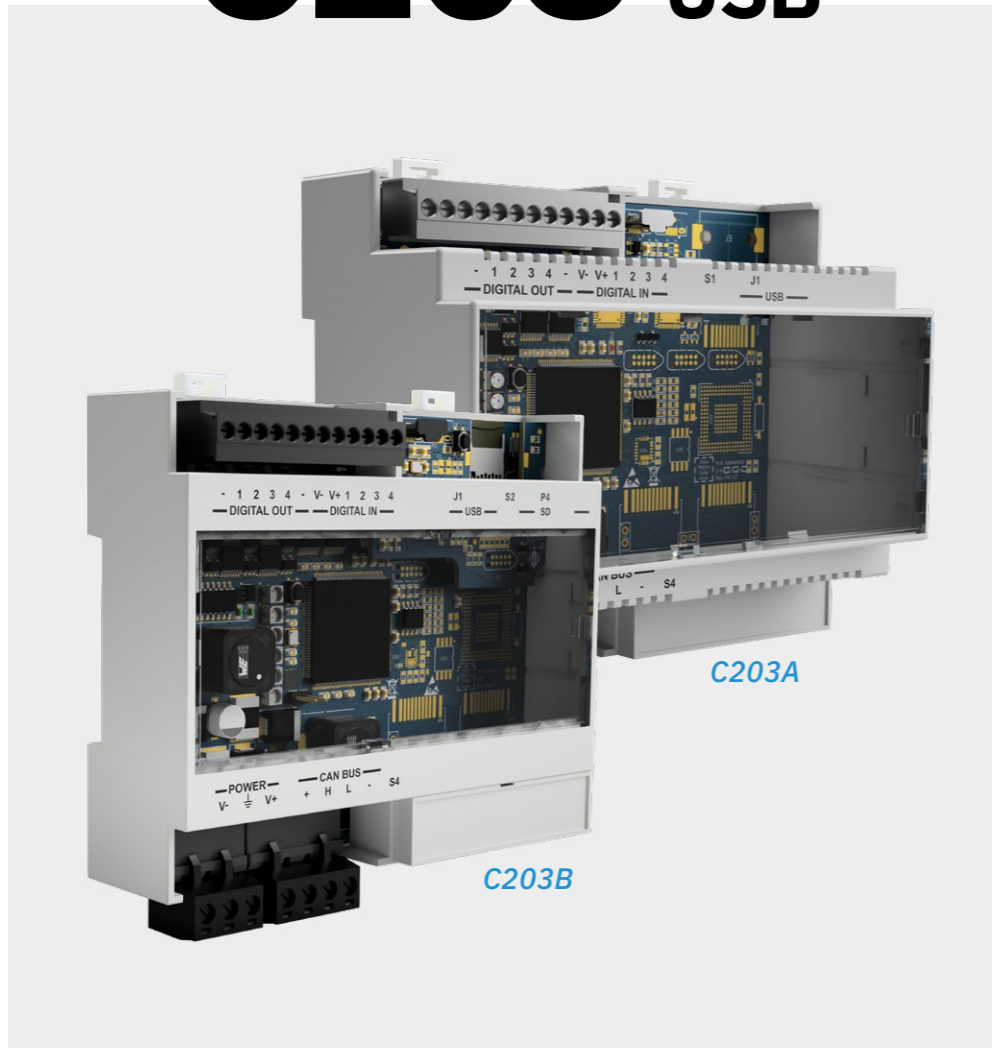

C203A | C203B

Digital I/O

C203 provides basic but robust control functionality for any Inxpect safety radar sensor. The Inxpect Safety Application works via USB to configure the sensitivity levels, safety functions, size of detection fields, and the functionality of the I/O ports of the control unit.

USB

Local configuration option.

Digital inputs

Two dual-channel inputs supporting the following functions:

- muting signal
- emergency stop signal
- restart signal

Four Output Signal Switching Devices

As safety outputs: two dual-channel safety OSSDs.

As auxiliary outputs: four auxiliary outputs, which can be configured as signal restart feedback, fault, muting status.

Dynamic setting of detection fields

There are up to 8 configurations switchable in real time.

SD backup, SD restore

Configurations and login credentials can be saved and restored via microSD card (only for C203B).

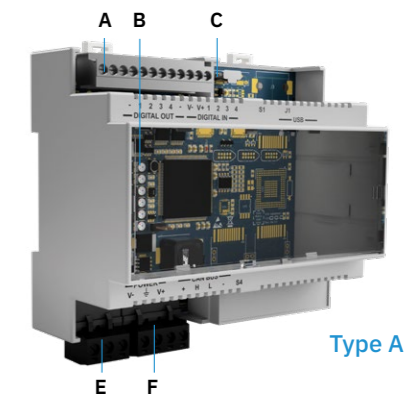

Type A

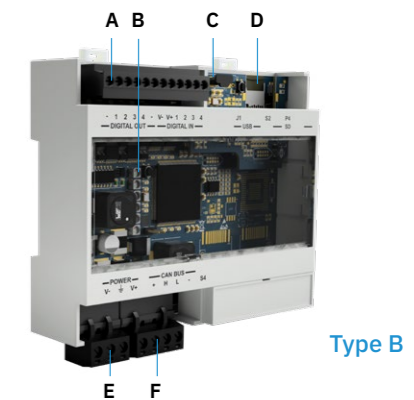

Type B

- A - I/O terminal block
- B - System status LED
- C - Micro USB port
- D - SD card (only for C203B)
- E - Power supply terminal block
- F - CAN bus terminal block for connecting the first sensor

Control Unit 200 SERIES

Digital I/O

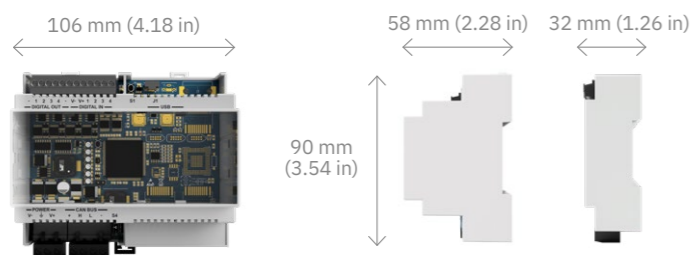

Safety Parameters:

- SIL2 (IEC 61508)
- PLd, Cat. 3 (ISO 13849)
- Performance Class D (IEC/TS 62998-1)

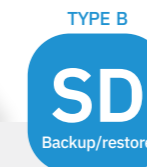

[A] Part No. **90304011**

[B] Part No. **90304111**

Technical details

Outputs	4 Outputs Signal Switching Devices (OSSDs) or 2 dual channel safety outputs
Safety outputs	High-side outputs (with extended protection function) Max voltage: 30 V dc Max current: 0.4 A Max power: 12 W
Inputs	2 dual channel TYPE3 digital inputs with common GND 4 single channel TYPE3 digital inputs with common GND [from FW 2.0.0 onwards]
Power supply	24 V dc (20–28 V dc) Max current: 1 A (no OSSD)
Max power consumption	5 W (no OSSD)
Assembly	DIN guide
Degree of protection	IP20
Terminals	Section: 1 mm ² Max Current: 4 A with 1 mm ² cables
System configuration	USB

Accessories

INDOOR



Adjustable protector kit

for indoor and outdoor applications

These adjustable protector kits are used for installing Inxpect Smart Sensors in harsh indoor and outdoor environments. The purpose of the support is to house the sensor at the desired height and protect it from the sides and from above.

INDOOR VERSION Part No. **90302ZAC**

30 degree slope downward
[RAL1021 powder coated metal]

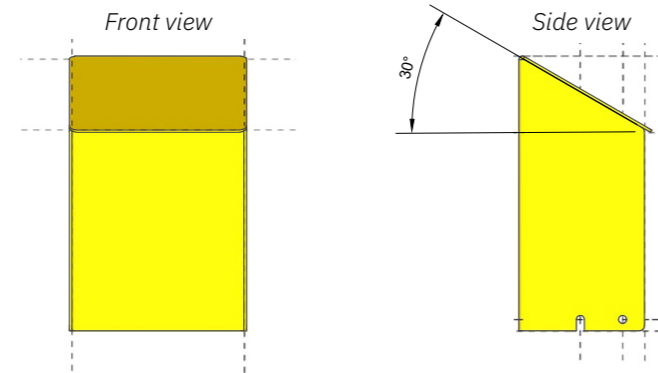

OUTDOOR VERSION Part No. **90302ZAD**

20 degree slope upward
[RAL1021 powder coated metal]

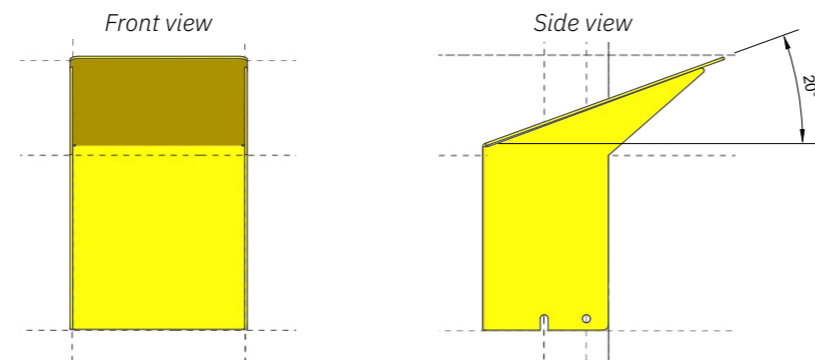

OUTDOOR



Metal protector for Smart Sensor 100 SERIES

[AISI 304 Stainless steel]

Part No. **90202ZAA**

The metal protector ensures that Inxpect S101A sensors perform at their best even in the most challenging environmental conditions, increasing their immunity to spurious detections while reducing the possibility of damage caused by accidental impact.

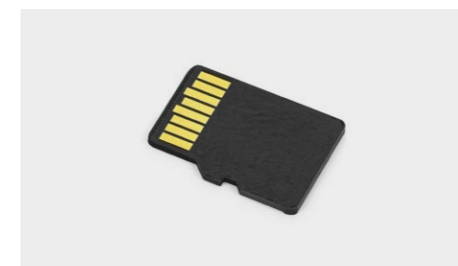
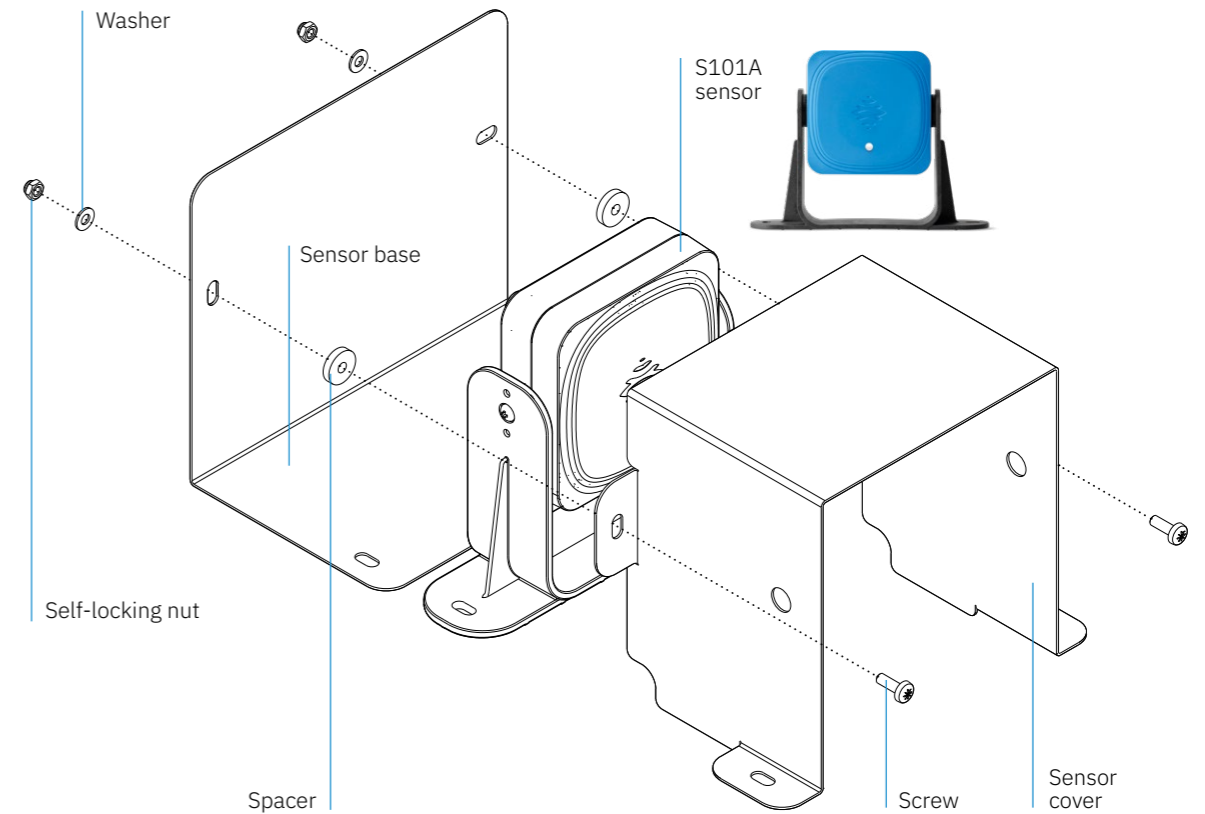

MicroSD card for Control Units Type B

Part No. **X0000011**

Cables

Control unit to sensor cable:

CAN bus, totally shielded.

Control unit side: free wires

Sensor side: connector M12, female, 5 poles, A-coded, angled 90°

Length	Smart Sensor 100 SERIES	Smart Sensor 200 SERIES
5 m	Part No. 08000003	Part No. 08000110
10 m	Part No. 08000004	Part No. 08000111
15 m	Part No. 08000006	Part No. 08000112
20 m	-	Part No. 08000113

Sensor to sensor cable:

CAN bus, totally shielded.

IN side: connector M12, female, 5 poles, A-coded, angled 90°

OUT side: connector M12, male, 5 poles, A-coded, angled 90°

Length	Smart Sensor 100 SERIES	Smart Sensor 200 SERIES
3 m	Part No. 08000007	Part No. 08000120
5 m	Part No. 08000013	Part No. 08000121
10 m	-	Part No. 08000122
15 m	Part No. 08000016	Part No. 08000123

Bus terminator:

M12, male, 5 poles, A-coded, straight 180°, resistance 120 Ω

Part No. **07000003**



Which cables and lengths do you need for your system?

Find out with our utility: [Cable Validator](#) (Sign in to Inxpect Tools).



Inxpect Safety Radar Equipment USE CASES

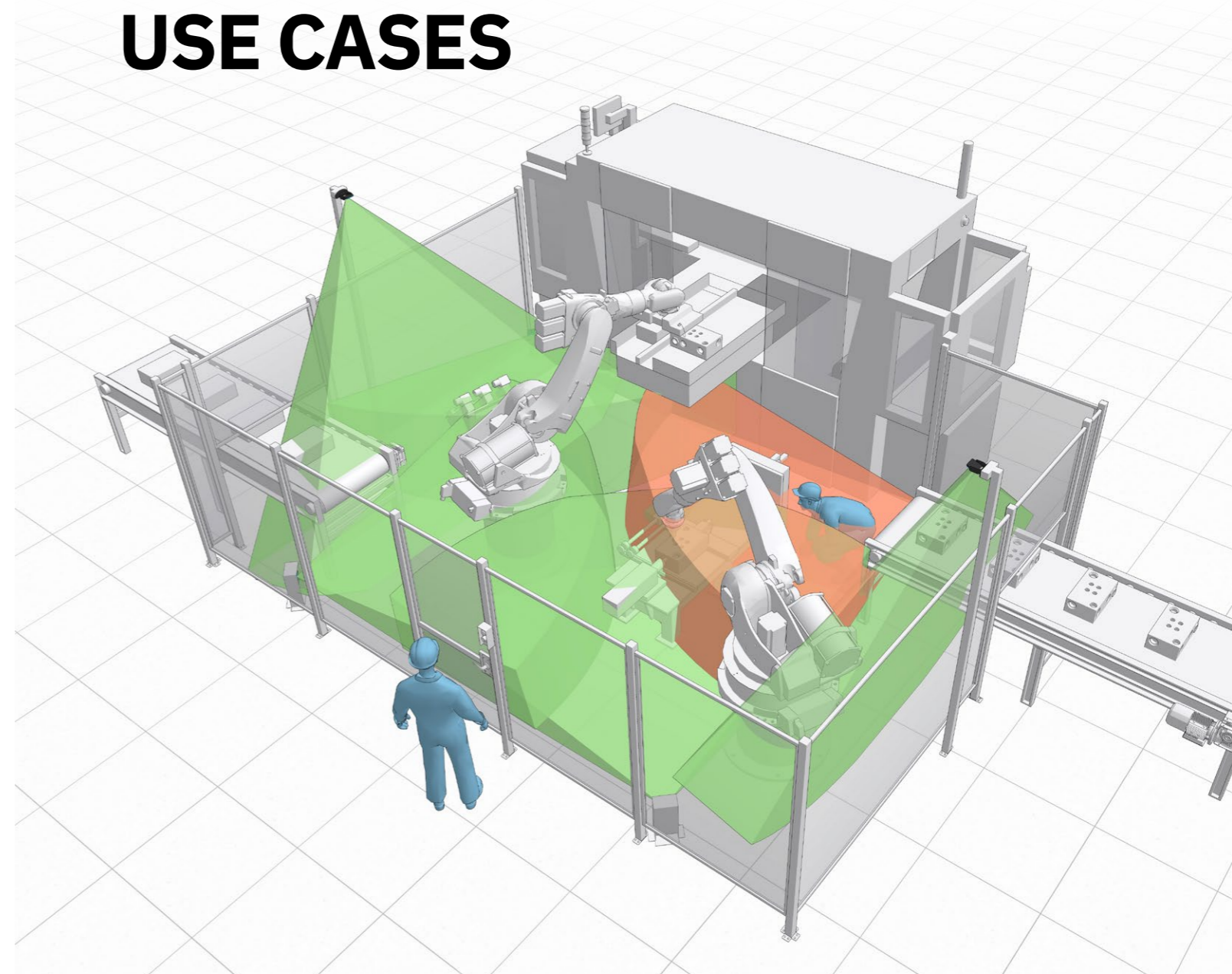

Restart prevention

Higher safety in robotic cells

Inxpect refines the state of art of robotics cell and the world of industrial safety in general. Inxpect 3D radars ensure maximum safety within dangerous areas by preventing unintentional restart while operator is in the dangerous area.

Main features:

- Natively 3D: volumetric coverage
- Adaptive to changing scenarios
- Prevent unintentional restarts
- Simplify access procedures
- Remove human error
- Improve productivity

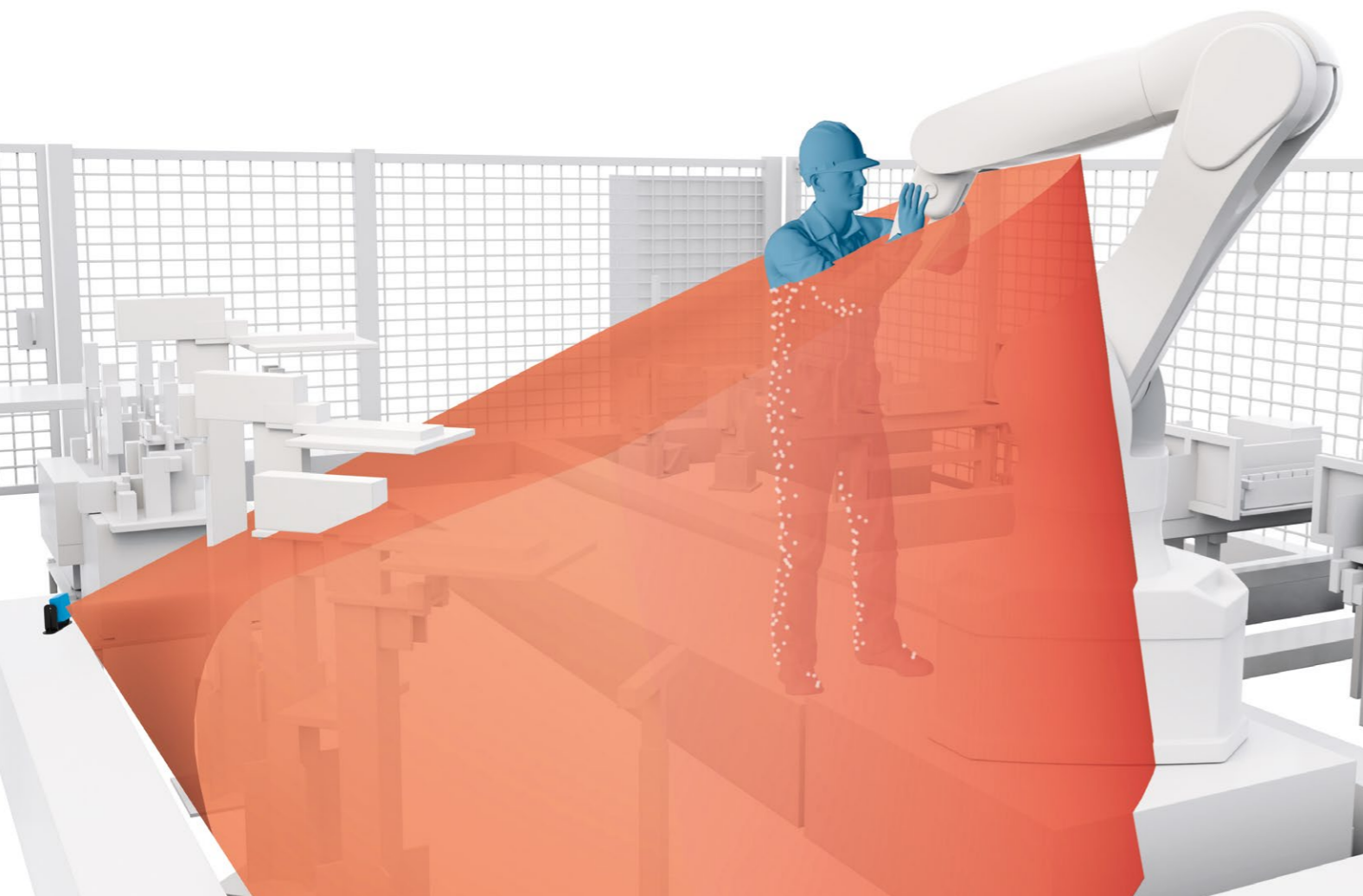

Restart prevention

Higher safety in wrapping stations

Inxpect redefines the state of the art of automatic wrapping and strapping stations. Inxpect 3D radars simplify human/machine interaction, prevent unintentional restarts and reduce residual risks, increasing efficiency and productivity.

Main features:

- Natively 3D: volumetric coverage
- Adaptive to changing scenarios
- Prevent accidental restart
- Simplify access procedures
- Improve human/machine interaction
- Remove human error
- Improve productivity

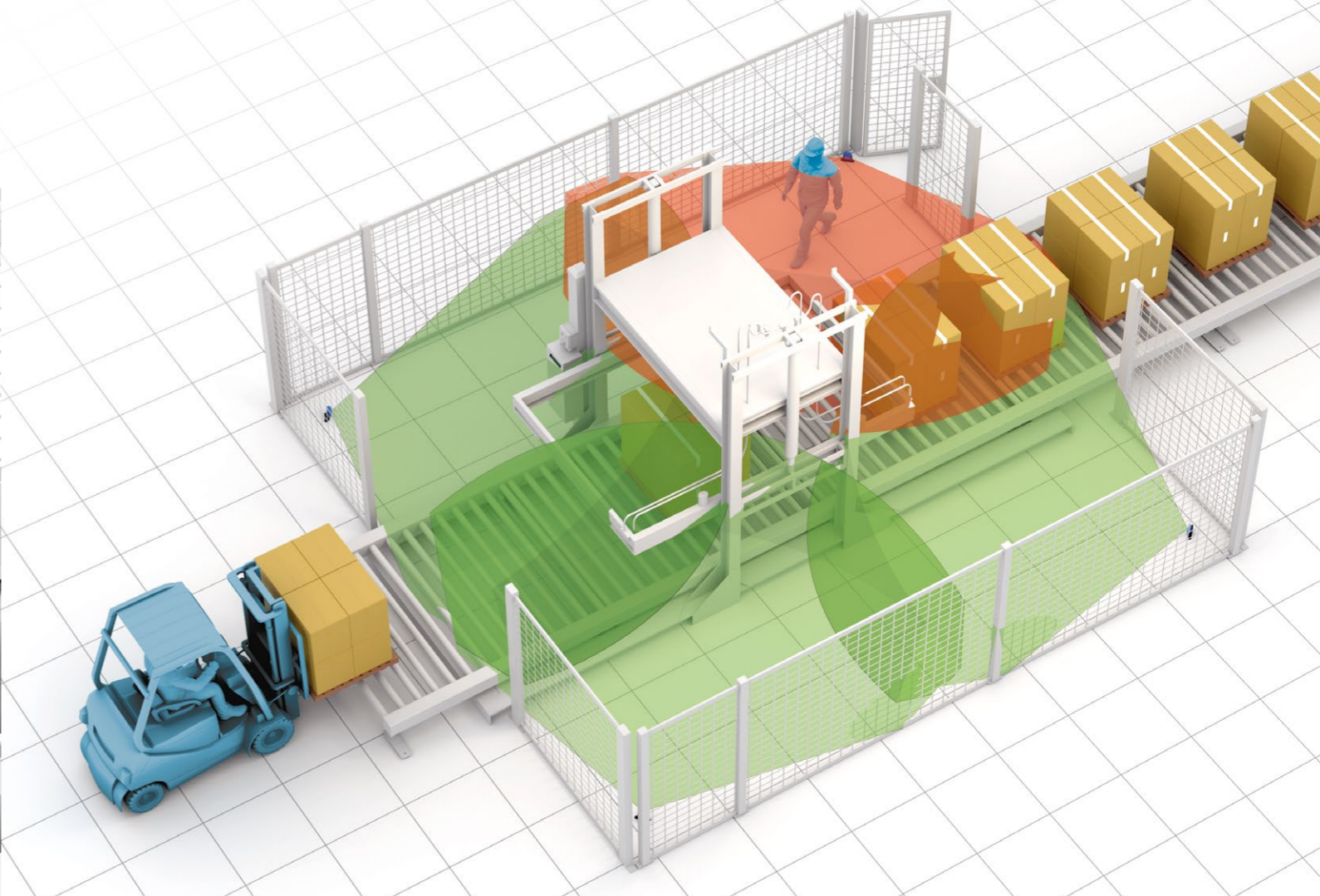

Smart collision avoidance

Indoor application: Automated Guided Vehicle

Inxpect brings dynamic safety to AGV. Inxpect 3D radars are ideal anti-collision sensor: they're robust to dust, debris, smoke, rain and light reflections. They are effective at detecting suspended loads, provide volumetric coverage and fit perfectly for indoor and outdoor applications.

Main features:

- Natively 3D: volumetric coverage
- Effective at detecting suspended loads
- Robust to smoke, dust, debris, rain, fog, snow and light reflections
- Indoor and outdoor applications

Smart collision avoidance

Indoor application: Pick and Place

Inxpect brings dynamic safety to pick and place applications. Inxpect 3D radar simplifies human/machine interaction, provides highly dynamic protection and allows for simple programming. Being adaptive to changing scenarios, Inxpect 3D radar increases efficiency and productivity.

Main features:

- Natively 3D: volumetric coverage
- Adaptive to changing scenarios
- Highly dynamic protection
- Simple programming

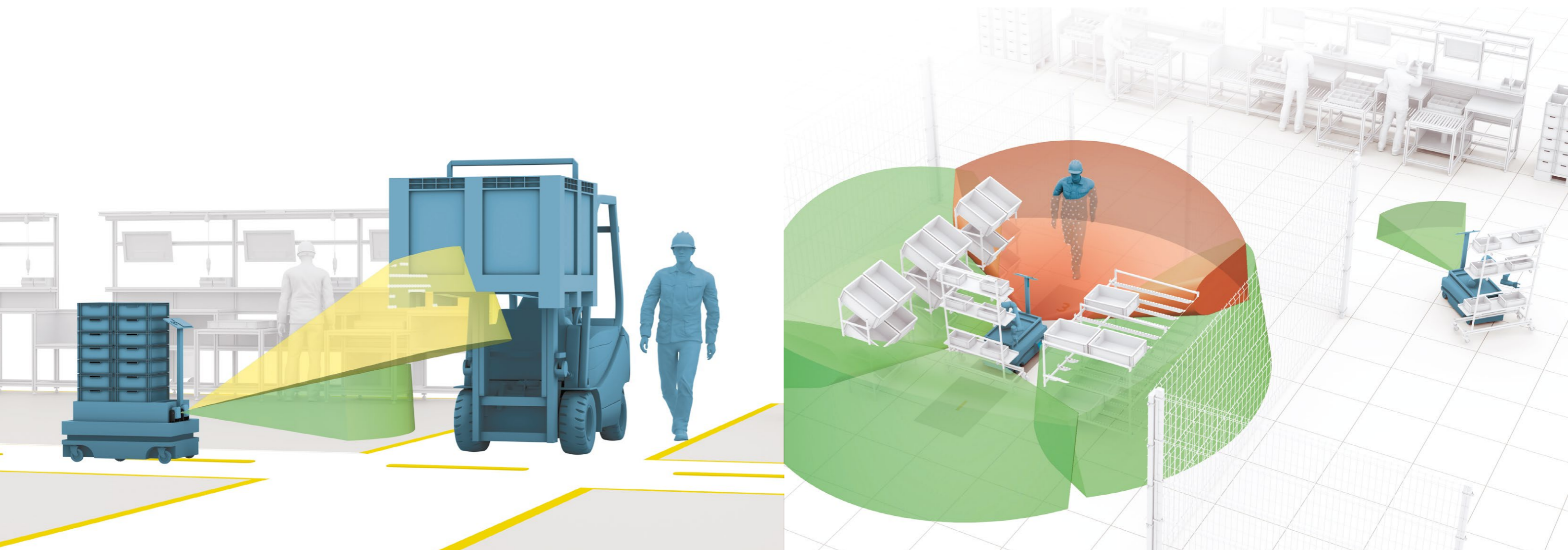

Smart collision avoidance

Outdoor application: Construction Site

Inxpect ensures maximum safety even in harsh environmental conditions. Dust, fog, rain and swarf generated by production processes do not cause false alarms. The volumetric coverage of Inxpect 3D radars prevents collision with suspended loads or airborne elements.

Main features:

- Robust to smoke, dust, debris, rain, fog, snow and light reflections
- Reduce false alarms
- 3D radar: volumetric protection
- Operating temperature -30° $+60^{\circ}$

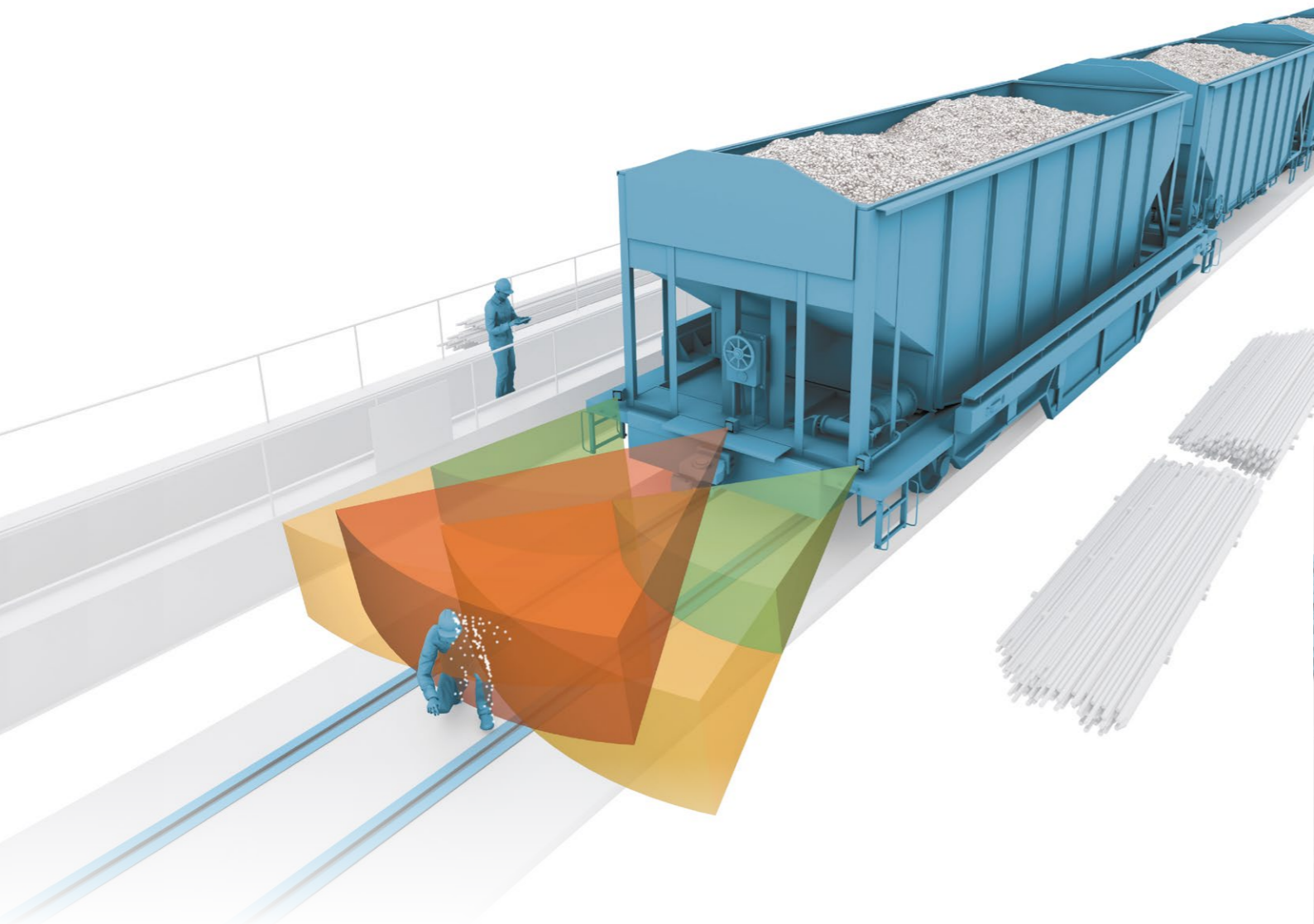

Smart collision avoidance

Outdoor application: Construction Site

Inxpect ensures maximum safety even in harsh environmental conditions. Inxpect 3D radars are an excellent aid to monitoring of the movement areas of operating machines because they allow to have a complete analysis of the area, even on multiple levels.

Main features:

- Robust to smoke, dust, debris, rain, fog, snow and light reflections
- Reduce false alarms
- Indoor and outdoor applications
- 3D radar: volumetric protection
- Operating temperature -30° $+60^{\circ}$



Access protection

Dynamic safety for mobile gantry machining

Inxpect redefines safety for mobile gantry machining. Thanks to the volumetric coverage, Inxpect 3D radars secure both the floor and the work surface, always ensuring maximum safety for operators.

Main features:

- Robust to debris: no more false alarms
- Natively 3D: volumetric coverage (for both floor and work surface areas)
- Prevent unintentional restarts while operator is in the dangerous area
- Remove human error

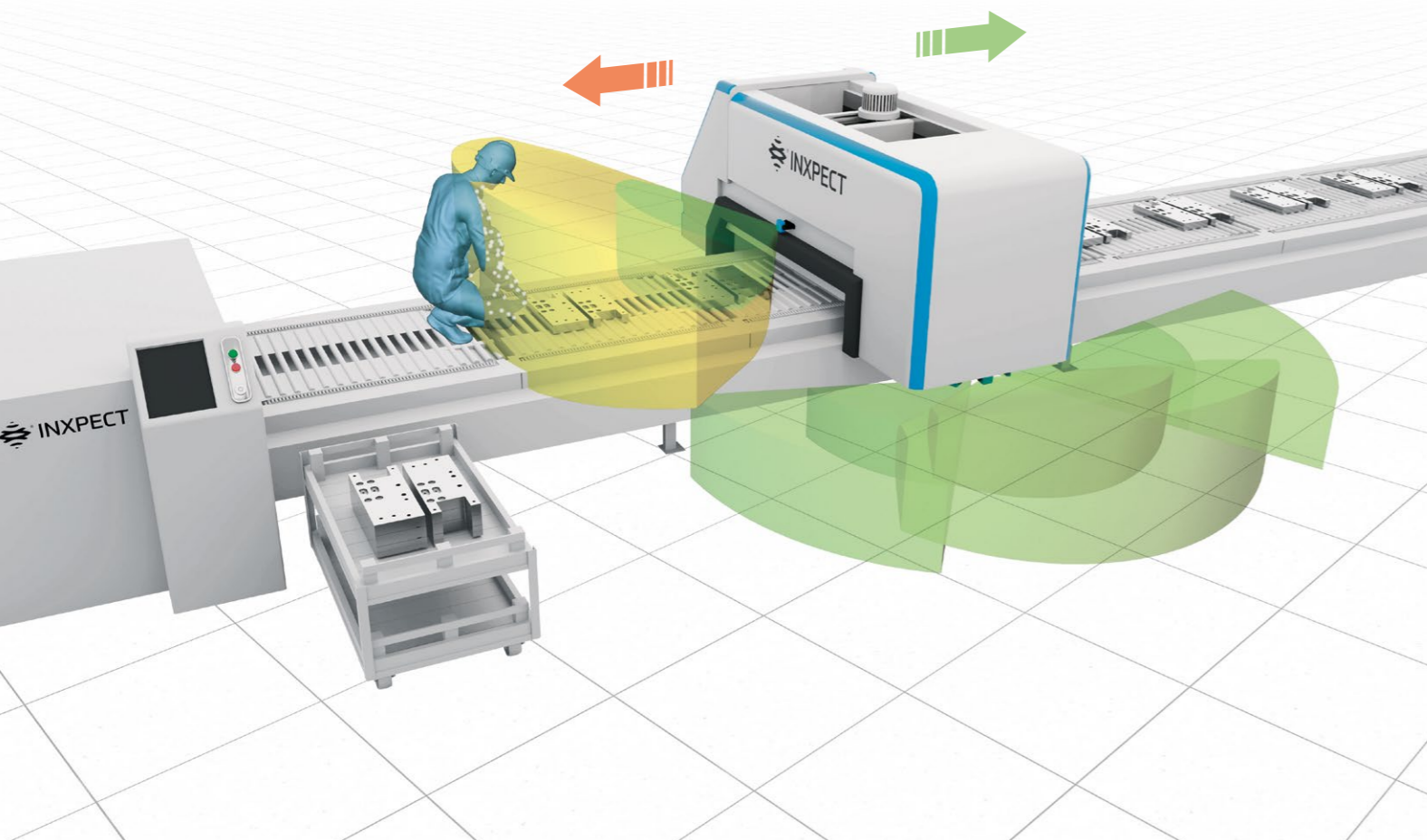

Access protection

Higher safety in robotic welding systems

Inxpect redefines safety for robotic welding systems with double electric rotary tables. Inxpect 3D radars can be positioned to create a volumetric barrier for access protection, increasing the safety of the setup while dramatically improving productivity.

Main features:

- Natively 3D: volumetric coverage
- Robust to debris: no more false alarms
- Virtually remove the need for protection barriers
- Simplify human/machine interaction
- Speed up the working process
- Improve productivity

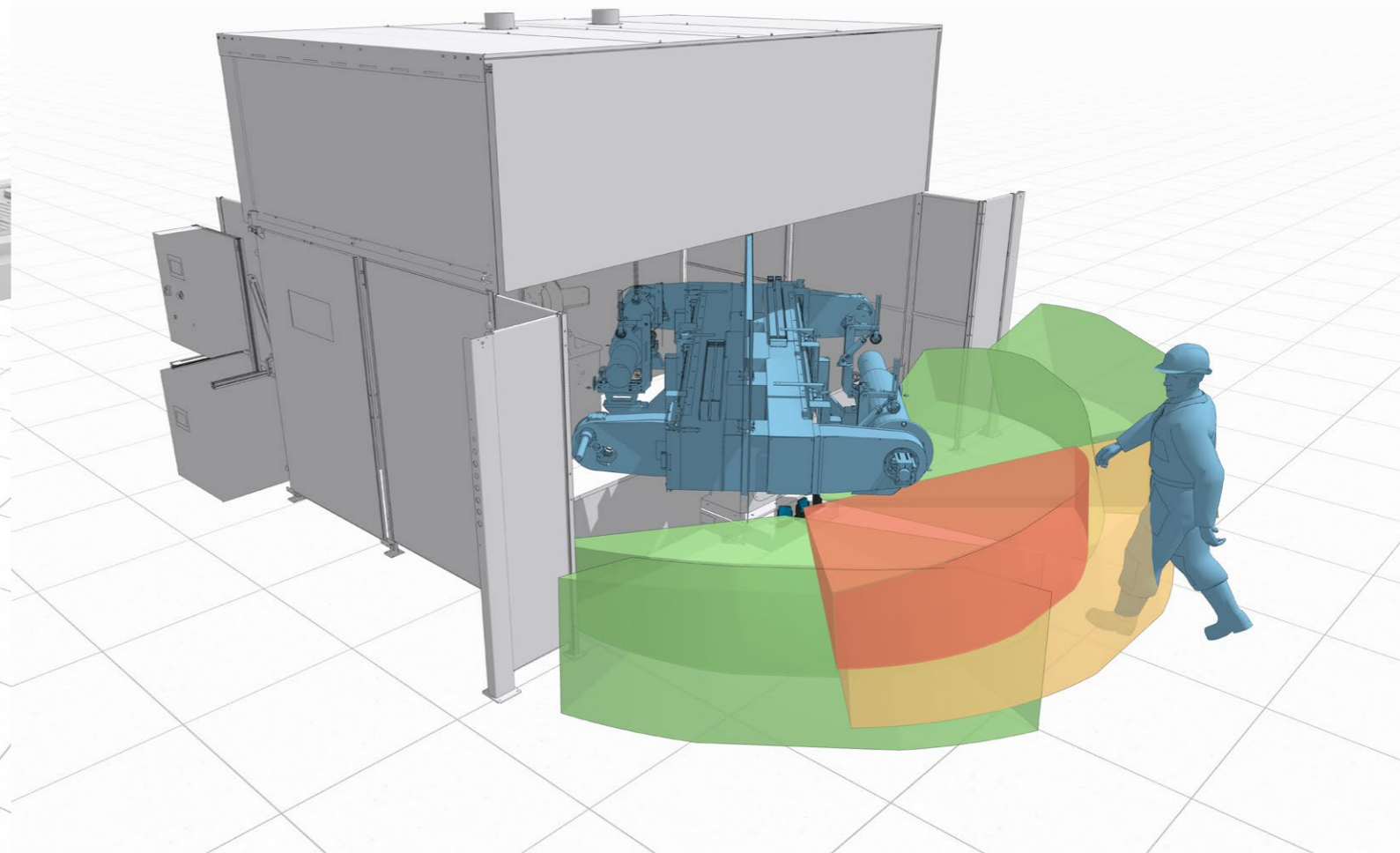

Access protection

Dynamic safety for robotic cells

Inxpect redefines safety for robotic cells. Thanks to the dynamic configurations, Inxpect's 3D radar sensors monitor the entrance to the dangerous area, always guaranteeing maximum safety for operators and at the same time without ever stopping the operating cycle of the machinery.

Main features:

- Dynamic configurations
- 3D radar: volumetric protection
- Simplify human/machine interaction
- Improve productivity

Restart prevention

Higher safety in automation robotic cells

Inxpect removes the human error for robotic cells. Inxpect 3D radars thanks to proprietary algorithms prevent unintentional restarts while operator is in the dangerous area and reduce residual risks, increasing efficiency and productivity.

Main features:

- Natively 3D: volumetric coverage
- Adaptive to changing scenarios
- Prevent unintentional restarts
- Improve human/machine interaction
- Remove human error
- Improve productivity

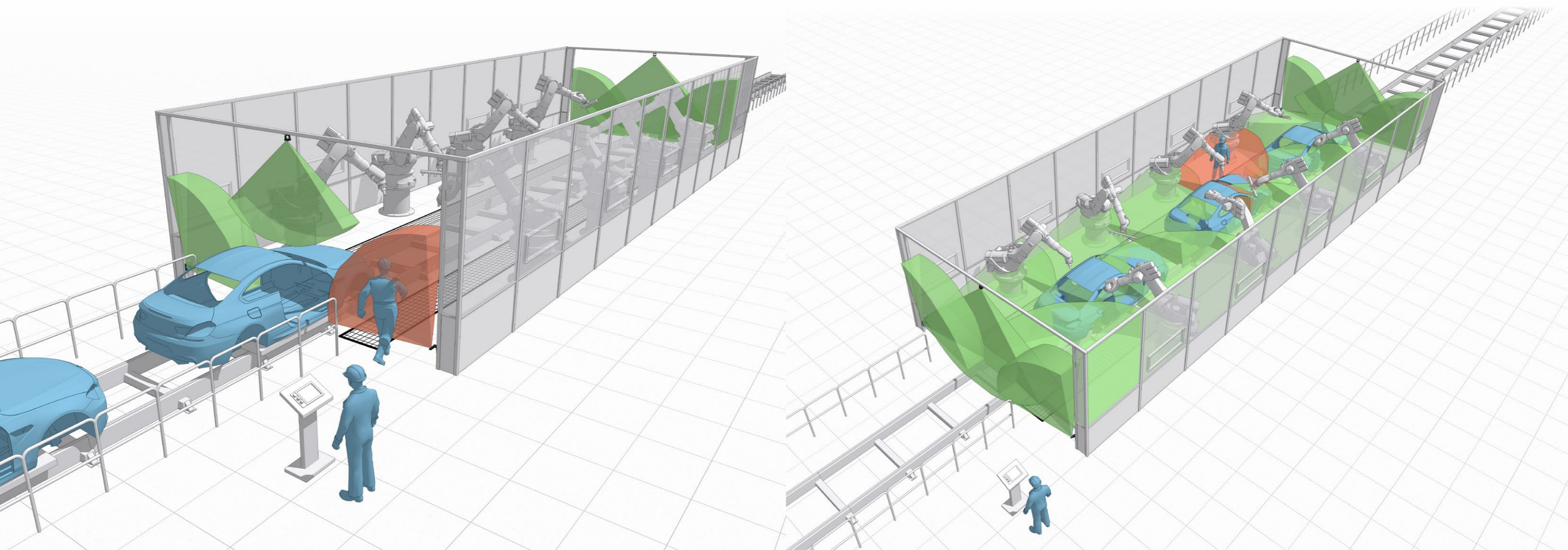

Restart prevention

Higher safety in automatic palletizing applications

Inxpect safely monitors access to loading/unloading area. This solution combines optical barriers and radars, redefining the state of the art and reducing residual risk. Inxpect 3D radars ensure the application safety: detecting if there is an operator in the area and stopping the machine until the area is clear.

Main features:

- Natively 3D: volumetric coverage (for both floor and work surface areas)
- Prevent unintentional restarts
- Highly dynamic protection
- Reduce residual risk
- Improve productivity

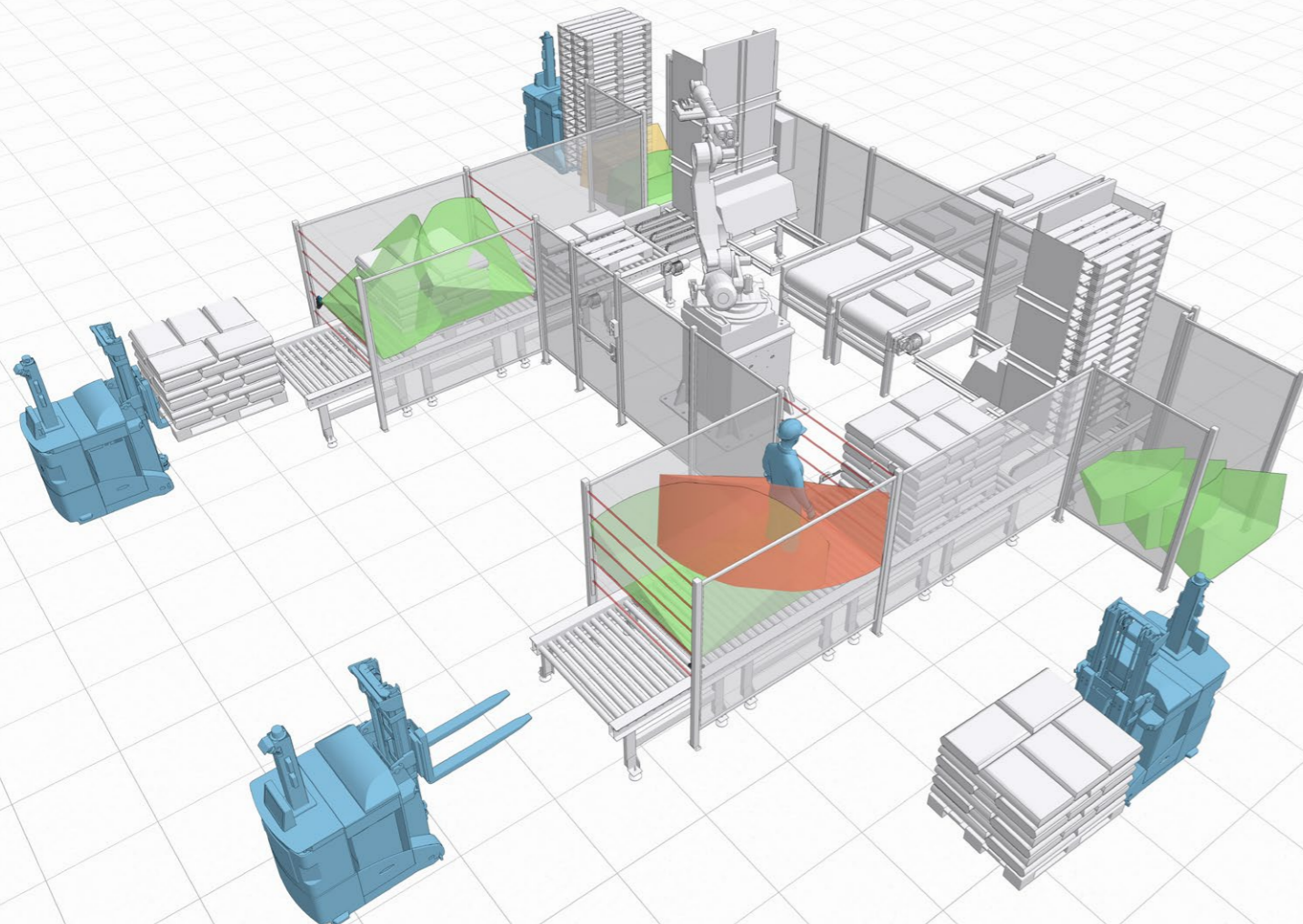

Restart prevention

Higher safety in automatic loading/unloading CNC applications

Inxpect redefines the state of the art of automatic loading/unloading CNC applications. Inxpect 3D radars simplify human/machine interaction, prevent unintentional restarts and reduce residual risks, increasing efficiency and productivity.

Main features:

- Natively 3D: volumetric coverage
- Prevent accidental restart
- Simplify access procedures
- Improve human/machine interaction
- Remove human error
- Improve productivity

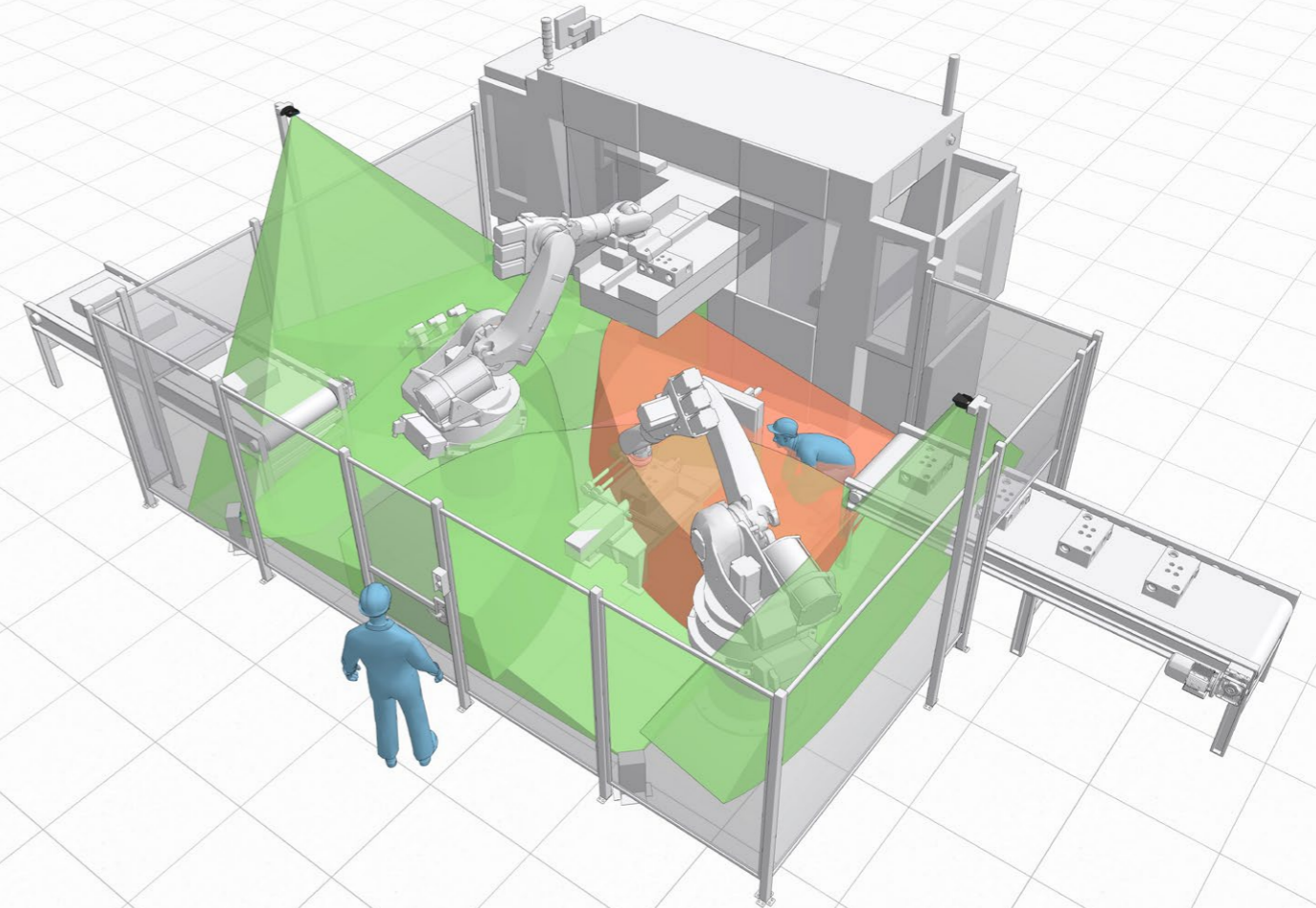



Inxpect S.p.A.
Via Serpente, 91
25131 Brescia (IT)
T +390305785105
safety@inxpect.com
www.inxpect.com

Inxpect Deutschland GmbH
Am Holzacker, 29
D-91085 Weisendorf (DE)
T +4991357366926
hello@inxpect.de
www.inxpect.de

Inxpect Electronics Co., Ltd.
1303, No.111 Yinli Center Building,
South Youyi Road, Xiqing Economic and
Technological Development Zone, Tianjin (CN)
hello-china@inxpect.com
www.inxpect.com

Inxpect Ibérica SL
C/ Sant Josep 28, Les Franqueses del Vallès
08520 Barcelona (ES)
T +34935507946
info@inxpect.es
www.inxpect.es

Inxpect North America Corp.
10375 N. Baldev Court, Suite B
Mequon, Wisconsin 53092 (US)
hello@inxpect.us
www.inxpect.us



SCATTERGOOD & JOHNSON LTD

ELECTRICAL ENGINEERING & FLUID CONTROL DISTRIBUTORS

Est.1899

At Scattergood & Johnson Ltd, we pride ourselves on being a technical distributor to specialist industries.

Working with a range of quality product manufacturers across a number of specialist markets, we are not your average 'box shifter' - we are your technical and supply chain partner.

We fully support every product we sell - for free! Our internal team and external sales engineers can answer any product or application question, no matter the complexity.

Backing up this technical ability is a range of 50,000+ products available from stock for nationwide next day delivery (same day if required!), or you can collect what you need from any of our trade counters around the UK.

Select your specialist interest below to learn more about how we can help.

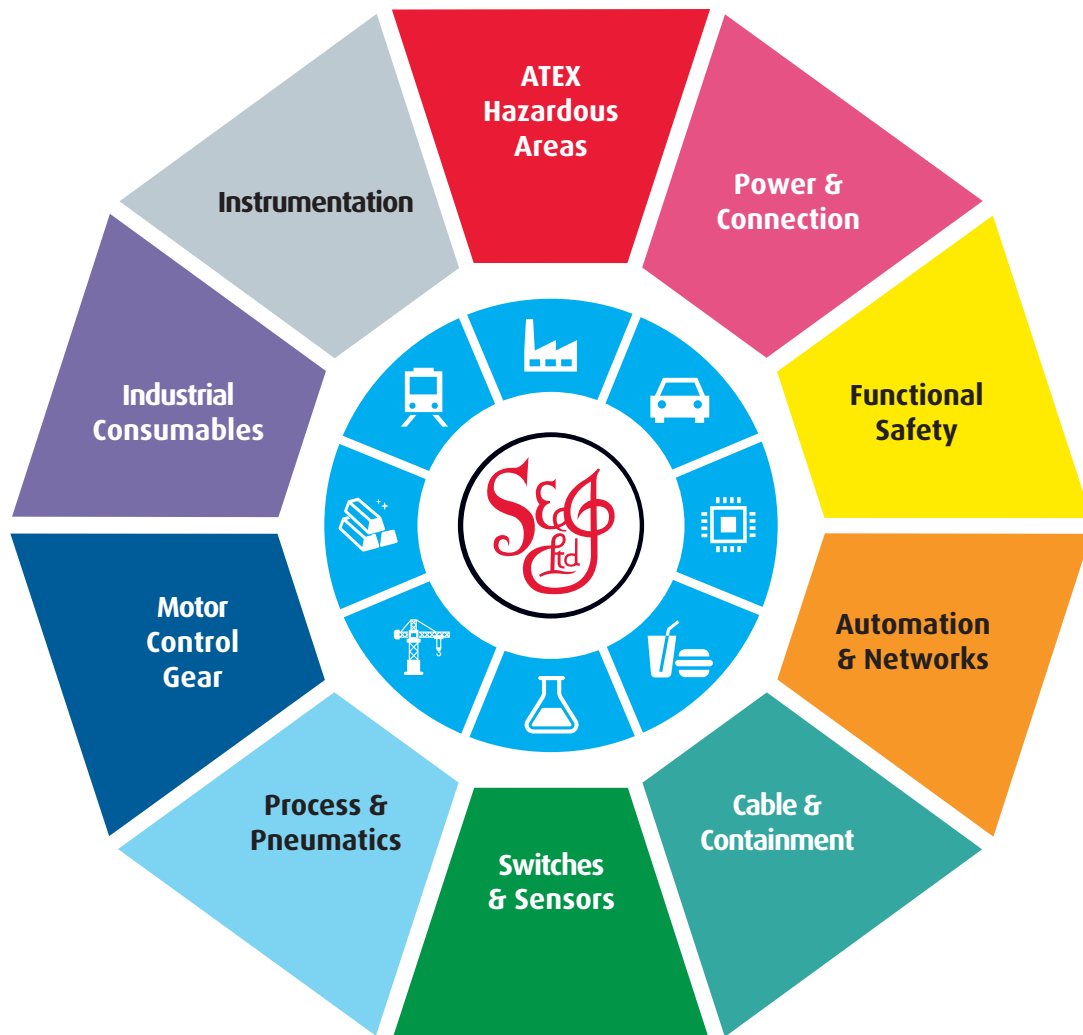

Online, In Branch and On the Road - Scattergood & Johnson Ltd, there when you need us.

www.scatts.co.uk