



## Inductive sensor

### NBN4-12GM50-A2-V1

- 4 mm non-flush
- Extended temperature range  
-40 ... +85 °C
- Extended operating voltage range
- Flexible use with versatile mounting opportunities



## Dimensions

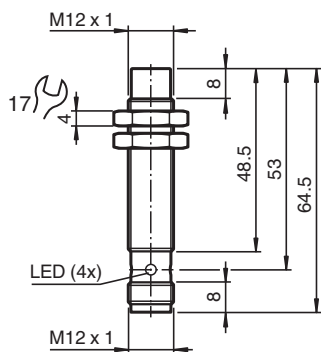

## Technical Data

### General specifications

Switching function		complementary
Output type		PNP
Rated operating distance	$s_n$	4 mm
Installation		non-flush
Output polarity		DC
Assured operating distance	$s_a$	0 ... 3.24 mm
Actuating element		mild steel, e. g. 1.0037, SR235JR (formerly St37-2) 12 mm x 12 mm x 1 mm
Reduction factor $r_{Al}$		0.47
Reduction factor $r_{Cu}$		0.43
Reduction factor $r_{304}$		0.85
Reduction factor $r_{Brass}$		0.55
Output type		4-wire

### Nominal ratings

Operating voltage	$U_B$	5 ... 36 V
Switching frequency	$f$	0 ... 2650 Hz

Release date: 2023-01-25 Date of issue: 2023-01-25 Filename: 326161-0072\_eng.pdf

Refer to "General Notes Relating to Pepperl+Fuchs Product Information".

Pepperl+Fuchs Group  
www.pepperl-fuchs.com

USA: +1 330 486 0001  
fa-info@us.pepperl-fuchs.com

Germany: +49 621 776 1111  
fa-info@de.pepperl-fuchs.com

Singapore: +65 6779 9091  
fa-info@sg.pepperl-fuchs.com

PEPPERL+FUCHS

## Technical Data

Hysteresis	H	typ. 5 %
Reverse polarity protection		reverse polarity protected
Short-circuit protection		pulsing
Voltage drop	$U_d$	$\leq 1$ V
Operating current	$I_L$	0 ... 200 mA
Off-state current	$I_r$	max. 20 $\mu$ A
No-load supply current	$I_o$	$\leq 15$ mA
Time delay before availability	$t_v$	$\leq 10$ ms
Switching state indicator		Multihole-LED, yellow
<b>Functional safety related parameters</b>		
MTTF <sub>d</sub>		1248 a
Mission Time (T <sub>M</sub> )		20 a
Diagnostic Coverage (DC)		0 %
<b>Conformity</b>		
PWIS conformity		VDMA 24364-A1/B2/C1/T100°C-W
<b>Compliance with standards and directives</b>		
Standard conformity		
Standards		EN 60947-5-2:2007 EN 60947-5-2/A1:2012 IEC 60947-5-2:2007 IEC 60947-5-2 AMD 1:2012
<b>Approvals and certificates</b>		
Protection class		II
Rated insulation voltage	$U_i$	36 V
Rated impulse withstand voltage	$U_{imp}$	500 V
UL approval		cULus Listed, General Purpose, Class 2 Power Source
CCC approval		CCC approval / marking not required for products rated $\leq 36$ V
<b>Ambient conditions</b>		
Ambient temperature		-40 ... 85 °C (-40 ... 185 °F)
Storage temperature		-40 ... 85 °C (-40 ... 185 °F)
<b>Mechanical specifications</b>		
Connection type		Connector plug
Housing material		brass , white bronze coated
Sensing face		PBT , green
Degree of protection		IP68
Connector		
Threading		M12 x 1
Number of pins		4
Mass		28 g
Tightening torque		0 ... 10 Nm
<b>General information</b>		
Scope of delivery		2 self locking nuts in scope of delivery

## Connection

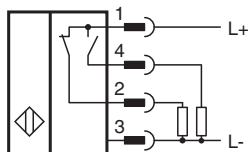



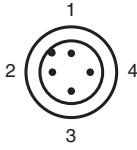





## Connection Assignment



Wire colors in accordance with EN 60947-5-2

1	BN	(brown)
2	WH	(white)
3	BU	(blue)
4	BK	(black)

## Accessories

	<b>BF 12</b>	Mounting flange, 12 mm
	<b>BF 12-F</b>	Plastic mounting adapter, 12 mm
	<b>V1-G-2M-PUR</b>	Female cordset single-ended M12 straight A-coded, 4-pin, PUR cable grey
	<b>V1-W-2M-PUR</b>	Female cordset single-ended M12 angled A-coded, 4-pin, PUR cable grey
	<b>V1-G-BK2M-PUR-U</b>	Female cordset single-ended M12 straight A-coded, 4-pin, PUR cable black, UL approved, drag chain suitable, torsion resistant
	<b>V1-W-BK2M-PUR-U</b>	Female cordset single-ended M12 angled A-coded, 4-pin, PUR cable black, UL approved, drag chain suitable, torsion resistant
	<b>V1-G-BK</b>	Female connector M12 straight A-coded 4-pin, for cable diameter 4 - 6 mm, field-attachable
	<b>V1-W-BK</b>	Female connector M12 angled A-coded 4-pin, for cable diameter 4 - 6 mm, field-attachable

Release date: 2023-01-25 Date of issue: 2023-01-25 Filename: 326161-0072\_eng.pdf

Refer to "General Notes Relating to Pepperl+Fuchs Product Information".

Pepperl+Fuchs Group  
www.pepperl-fuchs.com

USA: +1 330 486 0001  
fa-info@us.pepperl-fuchs.com

Germany: +49 621 776 1111  
fa-info@de.pepperl-fuchs.com

Singapore: +65 6779 9091  
fa-info@sg.pepperl-fuchs.com

 **PEPPERL+FUCHS**



**SCATTERGOOD  
& JOHNSON LTD**  
ELECTRICAL ENGINEERING & FLUID CONTROL DISTRIBUTORS

Est.1899

At Scattergood & Johnson Ltd, we pride ourselves on being a technical distributor to specialist industries.

Working with a range of quality product manufacturers across a number of specialist markets, we are not your average 'box shifter' - we are your technical and supply chain partner.

We fully support every product we sell - for free! Our internal team and external sales engineers can answer any product or application question, no matter the complexity.

Backing up this technical ability is a range of 50,000+ products available from stock for nationwide next day delivery (same day if required!), or you can collect what you need from any of our trade counters around the UK.

Select your specialist interest below to learn more about how we can help.



Online, In Branch and On the Road - Scattergood & Johnson Ltd, there when you need us.

**[www.scatts.co.uk](http://www.scatts.co.uk)**