

# Inductive sensor

## NRB15-30GS50-E2-V1



- Reduction factor = 1
- Magnetic field resistant
- Stainless steel housing



### Dimensions

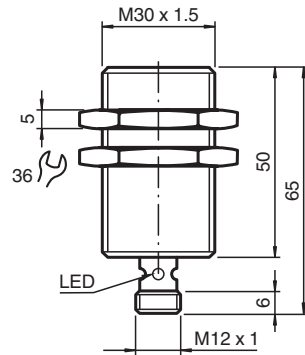

### Technical Data

General specifications		
Switching function		Normally open (NO)
Output type		PNP
Rated operating distance	$s_n$	15 mm
Installation		flush
Output polarity		DC
Assured operating distance	$s_a$	0 ... 12.15 mm
Reduction factor $r_{Al}$		1
Reduction factor $r_{Cu}$		1
Reduction factor $r_{304}$		1
Reduction factor $r_{St37}$		1
Output type		3-wire
Nominal ratings		
Operating voltage	$U_B$	10 ... 30 V
Switching frequency	$f$	0 ... 750 Hz
Hysteresis	$H$	typ. 3 %
Reverse polarity protection		reverse polarity protected

Release date: 2022-05-23 Date of issue: 2022-05-23 Filename: 261031\_eng.pdf

Refer to "General Notes Relating to Pepperl+Fuchs Product Information".

 Pepperl+Fuchs Group  
 www.pepperl-fuchs.com

 USA: +1 330 486 0001  
 fa-info@us.pepperl-fuchs.com

 Germany: +49 621 776 1111  
 fa-info@de.pepperl-fuchs.com

 Singapore: +65 6779 9091  
 fa-info@sg.pepperl-fuchs.com

## Technical Data

Short-circuit protection		pulsing
Voltage drop	$U_d$	$\leq 2$ V
Rated insulation voltage	$U_{BIS}$	60 V
Operating current	$I_L$	0 ... 200 mA
Off-state current	$I_r$	0 ... 0.5 mA typ. 0.1 $\mu$ A at 25 °C
No-load supply current	$I_0$	$\leq 14$ mA
Time delay before availability	$t_v$	max. 15 ms
Constant magnetic field	B	200 mT
Alternating magnetic field	B	200 mT
Switching state indicator		Multihole-LED, yellow
<b>Functional safety related parameters</b>		
MTTF <sub>d</sub>		1140.2 a
Mission Time (T <sub>M</sub> )		20 a
Diagnostic Coverage (DC)		0 %
<b>Compliance with standards and directives</b>		
Standard conformity		
Standards		EN 60947-5-2:2007 EN 60947-5-2/A1:2012 IEC 60947-5-2:2007 IEC 60947-5-2 AMD 1:2012
<b>Approvals and certificates</b>		
Protection class		II
Rated insulation voltage	$U_i$	60 V
Rated impulse withstand voltage	$U_{imp}$	800 V
UL approval		cULus Listed, Type 1 enclosure Class 2 power source
CCC approval		CCC approval / marking not required for products rated $\leq 36$ V
<b>Ambient conditions</b>		
Ambient temperature		-25 ... 70 °C (-13 ... 158 °F)
Storage temperature		-40 ... 85 °C (-40 ... 185 °F)
<b>Mechanical specifications</b>		
Connection type		Connector plug M12 x 1 , 4-pin
Housing material		Stainless steel 1.4305 / AISI 303
Sensing face		PBT
Degree of protection		IP67
Mass		113 g
<b>General information</b>		
Scope of delivery		2 self locking nuts in scope of delivery

## Connection

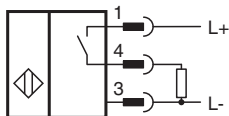



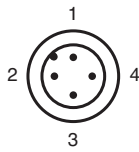

## Connection Assignment



Wire colors in accordance with EN 60947-5-2

1	BN	(brown)
2	WH	(white)
3	BU	(blue)
4	BK	(black)

## Accessories

	<b>BF 30</b>	Mounting flange, 30 mm
	<b>V1-W-2M-PUR</b>	Female cordset single-ended M12 angled A-coded, 4-pin, PUR cable grey
	<b>V1-G-OR2M-POC</b>	Female cordset single-ended M12 straight A-coded, 4-pin, POC cable welding-bead resistant orange, suitable for robotic applications, torsion resistant, oil resistant, molecularly cross-linked
	<b>V1-G-2M-PUR</b>	Female cordset single-ended M12 straight A-coded, 4-pin, PUR cable grey



**SCATTERGOOD  
& JOHNSON LTD**  
ELECTRICAL ENGINEERING & FLUID CONTROL DISTRIBUTORS

Est.1899

At Scattergood & Johnson Ltd, we pride ourselves on being a technical distributor to specialist industries.

Working with a range of quality product manufacturers across a number of specialist markets, we are not your average 'box shifter' - we are your technical and supply chain partner.

We fully support every product we sell - for free! Our internal team and external sales engineers can answer any product or application question, no matter the complexity.

Backing up this technical ability is a range of 50,000+ products available from stock for nationwide next day delivery (same day if required!), or you can collect what you need from any of our trade counters around the UK.

Select your specialist interest below to learn more about how we can help.



Online, In Branch and On the Road - Scattergood & Johnson Ltd, there when you need us.

**[www.scatts.co.uk](http://www.scatts.co.uk)**