

## ▶ PNOZ m EF 2DOR

# PILZ

THE SPIRIT OF SAFETY

Operating Manual-1005867-EN-04

- Configurable, safe small controllers PNOZmulti 2



This document is the original document.

Where unavoidable, for reasons of readability, the masculine form has been selected when formulating this document. We do assure you that all persons are regarded without discrimination and on an equal basis.

All rights to this documentation are reserved by Pilz GmbH & Co. KG. Copies may be made for the user's internal purposes. Suggestions and comments for improving this documentation will be gratefully received.

Pilz®, PIT®, PMI®, PNOZ®, Primo®, PSEN®, PSS®, PVIS®, SafetyBUS p®, SafetyEYE®, SafetyNET p®, the spirit of safety® are registered and protected trademarks of Pilz GmbH & Co. KG in some countries.



SD means Secure Digital

<b>1</b>	<b>Introduction</b> .....	<b>5</b>
1.1	Validity of documentation .....	5
1.2	Using the documentation .....	5
1.3	Definition of symbols .....	5
<b>2</b>	<b>Overview</b> .....	<b>7</b>
2.1	Scope of supply .....	7
2.2	Unit features .....	7
2.3	Front view .....	8
<b>3</b>	<b>Safety</b> .....	<b>9</b>
3.1	Intended use .....	9
3.2	Applicable documentation .....	10
3.3	System requirements .....	10
3.4	Safety regulations .....	10
3.4.1	Safety assessment .....	10
3.4.2	Use of qualified personnel .....	10
3.4.3	Warranty and liability .....	11
3.4.4	Disposal .....	11
3.4.5	For your safety .....	11
<b>4</b>	<b>Function description</b> .....	<b>12</b>
4.1	Integrated protection mechanisms .....	12
4.2	Functions .....	12
4.3	System reaction time .....	12
4.4	Block diagram .....	12
<b>5</b>	<b>Installation</b> .....	<b>13</b>
5.1	General installation guidelines .....	13
5.2	Dimensions in mm .....	13
5.3	Connecting the base unit and expansion modules .....	14
<b>6</b>	<b>Commissioning</b> .....	<b>15</b>
6.1	General wiring guidelines .....	15
6.2	Connection .....	15
6.3	Download modified project to the PNOZmulti system .....	16
<b>7</b>	<b>Operation</b> .....	<b>17</b>
7.1	LED indicators .....	17
7.2	Function test of the relay outputs .....	17
<b>8</b>	<b>Maintenance and testing</b> .....	<b>18</b>
<b>9</b>	<b>Technical details</b> .....	<b>19</b>
9.1	Safety characteristic data .....	22
<b>10</b>	<b>Supplementary data</b> .....	<b>23</b>
10.1	Service life graph for the relay contacts .....	23

Contents

---

<b>11</b>	<b>Order reference .....</b>	<b>25</b>
11.1	Product.....	25
11.2	Accessories.....	25
<b>12</b>	<b>EC declaration of conformity .....</b>	<b>26</b>
<b>13</b>	<b>UKCA-Declaration of Conformity .....</b>	<b>27</b>

# 1 Introduction

## 1.1 Validity of documentation

This documentation is valid for the product PNOZ m EF 2DOR from Version HW:01, FW:01.00.

This operating manual explains the function and operation, describes the installation and provides guidelines on how to connect the product.

## 1.2 Using the documentation

This document is intended for instruction. Only install and commission the product if you have read and understood this document. The document should be retained for future reference.

## 1.3 Definition of symbols

Information that is particularly important is identified as follows:



### **DANGER!**

This warning must be heeded! It warns of a hazardous situation that poses an immediate threat of serious injury and death and indicates preventive measures that can be taken.



### **WARNING!**

This warning must be heeded! It warns of a hazardous situation that could lead to serious injury and death and indicates preventive measures that can be taken.



### **CAUTION!**

This refers to a hazard that can lead to a less serious or minor injury plus material damage, and also provides information on preventive measures that can be taken.



### **NOTICE**

This describes a situation in which the product or devices could be damaged and also provides information on preventive measures that can be taken. It also highlights areas within the text that are of particular importance.

**INFORMATION**

This gives advice on applications and provides information on special features.

## 2 Overview

### 2.1 Scope of supply

- ▶ Expansion module PNOZ m EF 2DOR
- ▶ Jumper

### 2.2 Unit features

Application of the product PNOZ m EF 2DOR:

Expansion module for connection to a base unit from the PNOZmulti 2 system.

The product has the following features:

- ▶ Can be configured in the PNOZmulti Configurator
- ▶ Positive-guided relay outputs:
  - 2 safety outputs up to PL c of EN ISO 13849-1
  - 1 safety output up to PL e of EN ISO 13849-1 and up to SIL 3 of EN IEC 62061
- ▶ LED display for:
  - Error messages
  - Diagnostics
  - Supply voltage
  - Output circuits
- ▶ Plug-in connection terminals:

Either spring-loaded terminal or screw terminal available as accessories (see Order references)
- ▶ Please refer to the document "PNOZmulti System Expansion" for the PNOZmulti base units that can be connected.

## 2.3 Front view

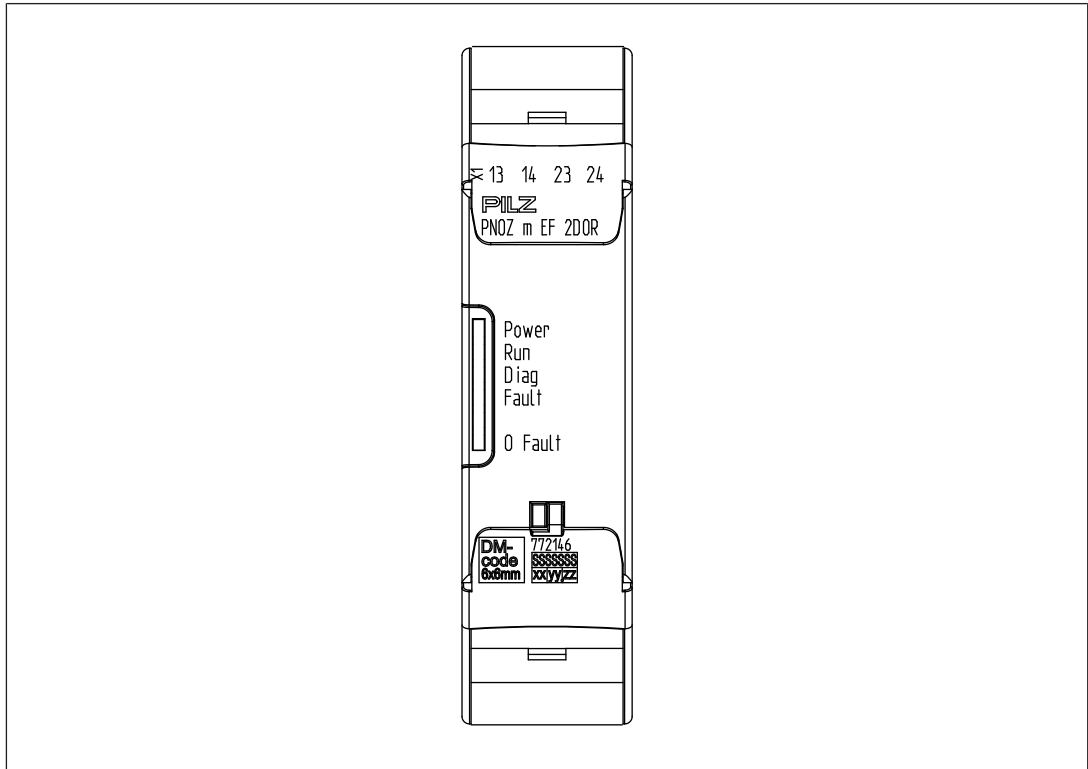

Legend:

- ▶ Outputs O0 – O1
- ▶ LEDs:
  - POWER
  - Run
  - Diag
  - Fault
  - O Fault

## 3 Safety

### 3.1 Intended use

The expansion module may only be connected to a base unit from the configurable system PNOZmulti 2 (please refer to the document "PNOZmulti System Expansion" for details of the base units that can be connected).

The configurable system PNOZmulti 2 is used for the safety-related interruption of safety circuits and is designed for use in:

- ▶ Emergency stop equipment
- ▶ Safety circuits in accordance with VDE 0113 Part 1 and EN 60204-1

#### Use in furnaces

The module PNOZ m EF 2DOR can be used in furnaces in accordance with EN 298. If the module's relay outputs shut down the entire fuel supply and the furnace is used in continuous operation, appropriate external measures must be used to establish diversity of the shutdown elements (requirement of EN 50156-1). For example, an appropriate measure may be an additional, monitored switching element (contactor or relay), which is activated by a safe semiconductor output and is switched in series with both relay outputs.

#### Regulation on appliances burning gaseous fuels (EU) 2016/426

The product PNOZ m EF 2DOR fulfils the requirements of the Regulation on appliances burning gaseous fuels (EU) 2016/426 and it can be used as an equipment under the terms of the directive.

#### Year of manufacture

The year of manufacture is specified on the product after the reference YOM (Year of Manufacturing).

#### Improper use

The following is deemed improper use in particular

- ▶ Any component, technical or electrical modification to the product,
- ▶ Use of the product outside the areas described in this operating manual,
- ▶ Use of the product outside the technical details (see [Technical details](#)  19).



#### NOTICE

##### EMC-compliant electrical installation

The product is designed for use in an industrial environment. The product may cause interference if installed in other environments. If installed in other environments, measures should be taken to comply with the applicable standards and directives for the respective installation site with regard to interference.

## 3.2 Applicable documentation

This document includes only part of the information required for the use of the device. To understand and correctly use the product you must read further documents.

Please read the following documents:

- ▶ "PNOZmulti Safety Manual"
- ▶ "PNOZmulti Installation Manual"
- ▶ The advanced functions of the device are described in the online help for the PNOZmulti Configurator, in the "PNOZmulti Communication Interfaces" document and in "PNOZmulti Special Applications". Only use these functions once you have read and understood the documentation.
- ▶ The PNOZmulti base units that can be connected, the max. number of modules that can be connected and the reaction times of the system can be seen from the document "PNOZmulti System Expansion".

## 3.3 System requirements

Please refer to the "Product Modifications PNOZmulti" document in the "Version overview" section for details of which versions of the base unit and PNOZmulti Configurator can be used for this product.

## 3.4 Safety regulations

### 3.4.1 Safety assessment

Before using a device it is necessary to perform a safety assessment in accordance with the Machinery Directive.

Functional safety is guaranteed for the product as a single component. However, this does not guarantee the functional safety of the overall plant/machine. In order to achieve the required safety level for the overall plant/machine, define the safety requirements for the plant/machine and then define how these must be implemented from a technical and organisational standpoint.

### 3.4.2 Use of qualified personnel

The products may only be assembled, installed, programmed, commissioned, operated, maintained and decommissioned by competent persons.

A competent person is someone who, because of their training, experience and current professional activity, has the specialist knowledge required to test, assess and operate the work equipment, devices, systems, plant and machinery in accordance with the general standards and guidelines for safety technology.

It is the company's responsibility only to employ personnel who

- ▶ Are familiar with the basic regulations concerning health and safety / accident prevention,
- ▶ Have read and understood the information provided in this description under "Safety",
- ▶ And have a good knowledge of the generic and specialist standards applicable to the specific application.

### 3.4.3 Warranty and liability

All claims to warranty and liability will be rendered invalid if

- ▶ The product was used contrary to the purpose for which it is intended,
- ▶ Damage can be attributed to not having followed the guidelines in the manual,
- ▶ Operating personnel are not suitably qualified,
- ▶ Any type of modification has been made (e.g. exchanging components on the PCB boards, soldering work etc.).

### 3.4.4 Disposal

- ▶ In safety-related applications, please comply with the mission time  $T_M$  in the safety-related characteristic data.
- ▶ When decommissioning, please comply with local regulations regarding the disposal of electronic devices (e.g. Electrical and Electronic Equipment Act).

### 3.4.5 For your safety

The unit meets all the necessary conditions for safe operation. However, you should always ensure that the following safety requirements are met:

- ▶ This operating manual only describes the basic functions of the unit. The expanded functions are described in the PNOZmulti Configurator's online help. Only use these functions once you have read and understood the documentations.
- ▶ Do not open the housing or make any unauthorised modifications.
- ▶ Please make sure you shut down the supply voltage when performing maintenance work (e.g. exchanging contactors).

## 4 Function description

### 4.1 Integrated protection mechanisms

The relay meets the following safety requirements:

- ▶ The circuit is redundant with built-in self-monitoring.
- ▶ The safety device remains effective in the case of a component failure.
- ▶ The relay contacts meet the requirements for protective separation through increased insulation compared with all other circuits in the safety system.
- ▶ A defective relay contact will be detected during switching.

### 4.2 Functions

The expansion module provides additional relay outputs.

The function of the outputs on the safety system depends on the safety circuit created using the PNOZmulti Configurator. A chip card is used to download the safety circuit to the base unit. The base unit has 2 microcontrollers that monitor each other. They evaluate the input circuits on the base unit and expansion modules and switch the outputs on the base unit and expansion modules accordingly.

The online help on the PNOZmulti Configurator contains descriptions of the operating modes and all the functions of the PNOZmulti safety system, plus connection examples.

### 4.3 System reaction time

Calculation of the maximum reaction time between an input switching off and a linked output in the system switching off is described in the document "PNOZmulti System Expansion".

### 4.4 Block diagram

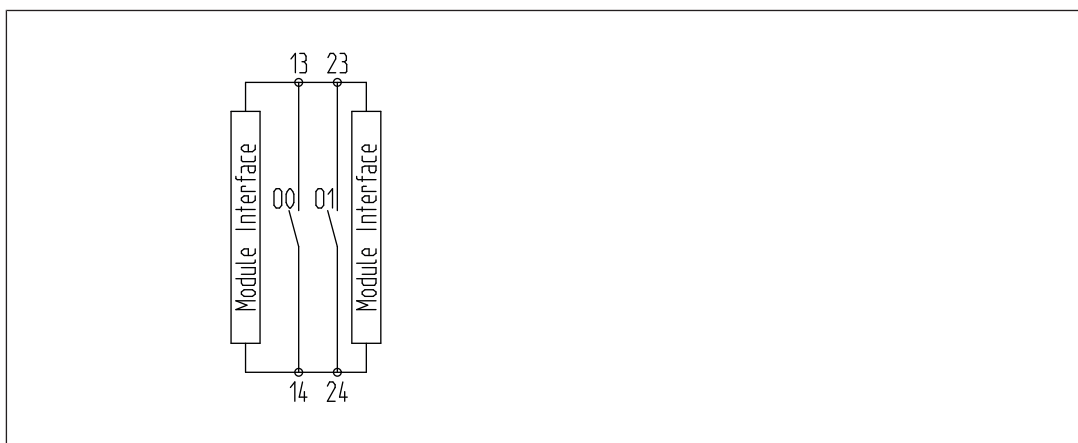

## 5 Installation

### 5.1 General installation guidelines

- ▶ The unit should be installed in a control cabinet with a protection type of at least IP54.
- ▶ Fit the safety system to a horizontal mounting rail. The venting slots must face upward and downward. Other mounting positions could damage the safety system.
- ▶ Use the locking elements on the rear of the unit to attach it to a mounting rail.
- ▶ In environments exposed to heavy vibration, the unit should be secured using a fixing element (e.g. retaining bracket or end angle).
- ▶ Open the locking slide before lifting the unit from the mounting rail.
- ▶ To comply with EMC requirements, the mounting rail must have a low impedance connection to the control cabinet housing.
- ▶ The ambient temperature of the PNOZmulti units in the control cabinet must not exceed the figure stated in the technical details. Air conditioning may otherwise be required.



#### NOTICE

Damage due to electrostatic discharge!

Electrostatic discharge can damage components. Ensure against discharge before touching the product, e.g. by touching an earthed, conductive surface or by wearing an earthed armband.

### 5.2 Dimensions in mm

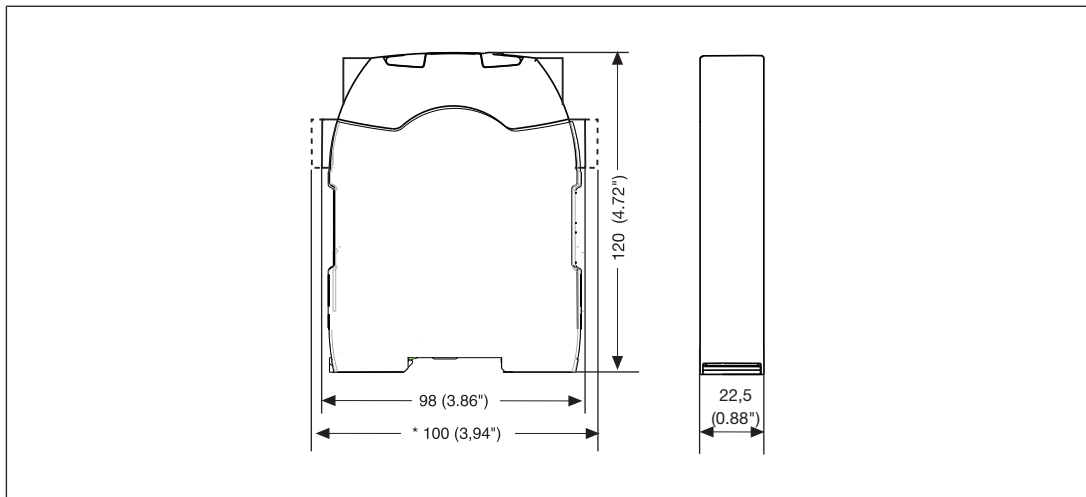

### 5.3 Connecting the base unit and expansion modules

Connect the base unit and the expansion modules as described in the operating manuals for the base modules.

- ▶ The terminator must be fitted to the last expansion module
- ▶ Install the expansion module in the position configured in the PNOZmulti Configurator.

The position of the expansion modules is defined in the PNOZmulti Configurator. The expansion modules are connected to the left or right of the base unit, depending on the type.

Please refer to the document "PNOZmulti System Expansion" for details of the number of modules that can be connected to the base unit and the module types.

## 6 Commissioning

### 6.1 General wiring guidelines

The wiring is defined in the circuit diagram of the PNOZmulti Configurator.

Please note:

- ▶ Information given in the [Technical details \[19\]](#) must be followed.
- ▶ The position of the expansion module is specified in the Hardware configuration of the PNOZmulti Configurator.
- ▶ Use copper wiring with a temperature stability of 75 °C.
- ▶ To prevent contact welding, a fuse should be connected before the output contacts (see [Technical details \[19\]](#)).
- ▶ Adequate protection must be provided on all output contacts with capacitive and inductive loads.

### 6.2 Connection

Relay outputs		
Dual output		
Single output		

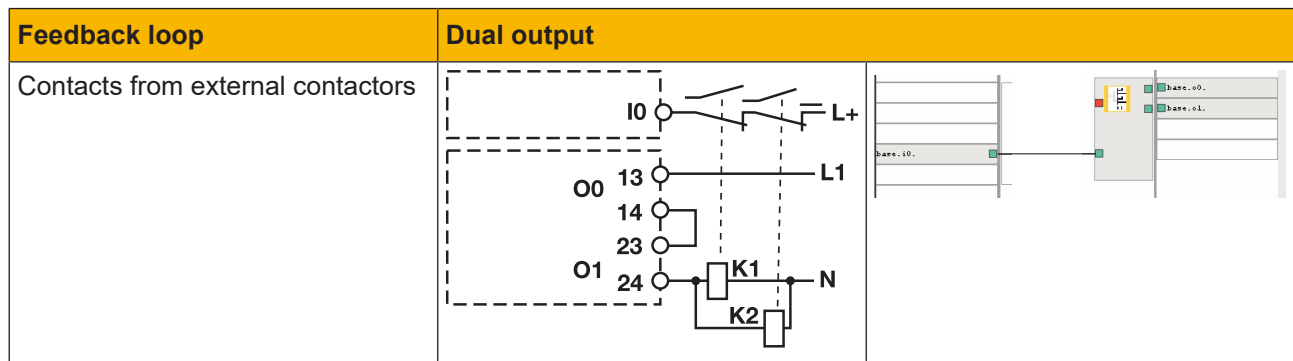

### 6.3 Download modified project to the PNOZmulti system

As soon as an additional expansion module has been connected to the system, the project must be amended in the PNOZmulti Configurator and downloaded back into the base unit. Proceed as described in the operating manual for the base unit.



#### NOTICE



For the commissioning and after every user program change, you must check whether the safety devices are functioning correctly.













## 7 Operation

The PNOZmulti system is ready for operation when the "POWER" and "RUN" LEDs on the base unit are lit continuously.

### 7.1 LED indicators

#### Legend

-  LED on
-  LED flashes
-  LED off

LED					Error
POWER	Run	Diag	Fault	OFault	
					No supply voltage
					Expansion module PNOZ m EF 2DOR running without error.
					Expansion module PNOZ m EF 2DOR is in a STOP condition.
					Internal error on the expansion module PNOZ m EF 2DOR or on the overall system. Expansion module is in a safe condition.
					External error on the expansion module PNOZ m EF 2DOR or on the overall system. Expansion module is in a safe condition.
					Internal error on the outputs of the expansion module PNOZ m EF 2DOR. Expansion module is in a safe condition.
					External error on the outputs of the expansion module PNOZ m EF 2DOR. Expansion module is in a safe condition, e.g. defective feedback loop.

### 7.2 Function test of the relay outputs

When the relay outputs are switched on, the mechanical contact on the relay cannot be tested automatically. Depending on the operational environment, measures to detect the non-opening of switching elements may be required under some circumstances.

When the product is used in accordance with the European Machinery Directive, a check must be carried out to ensure that the safety contacts on the relay outputs open correctly. Start the device again or open the safety contacts (switch off output), so that the internal diagnostics can check the correct opening of the safety contacts

- ▶ for SIL 3/PL e at least 1x per month
- ▶ for SIL 2/PL d at least 1x per year

## 8 Maintenance and testing

It is not necessary to perform maintenance work on the product in normal operation. Please return any faulty products to Pilz.

## 9 Technical details

<b>General</b>	
Certifications	<b>CE, TÜV, UKCA</b>
Application range	<b>Failsafe</b>
Module's device code	<b>00EAh</b>
<b>Electrical data</b>	
Supply voltage	
for	<b>Module supply</b>
internal	<b>Via base unit</b>
Voltage	<b>24 V</b>
Kind	<b>DC</b>
Current consumption	<b>75 mA</b>
Power consumption	<b>2 W</b>
Max. power dissipation of module	<b>2,5 W</b>
Status indicator	<b>LED</b>
Permitted loads	<b>inductive, resistive</b>
<b>Relay outputs</b>	
Number of relay outputs	<b>2</b>
Utilisation category	
In accordance with the standard	<b>EN 60947-4-1</b>
Utilisation category of safety contacts	
AC1 at	<b>250 V</b>
Min. current	<b>10 mA</b>
Max. current	<b>6 A</b>
Max. power	<b>1500 VA</b>
DC1 at	<b>24 V</b>
Min. current	<b>10 mA</b>
Max. current	<b>6 A</b>
Max. power	<b>144 W</b>
Utilisation category	
In accordance with the standard	<b>EN 60947-5-1</b>
Utilisation category of safety contacts	
AC15 at	<b>230 V</b>
Max. current	<b>3 A</b>
Max. power	<b>690 W</b>
DC13 (6 cycles/min) at	<b>24 V</b>
Max. current	<b>3 A</b>
Max. power	<b>72 W</b>
Airgap creepage between	
Relay contacts	<b>3 mm</b>
Relay contacts and other circuits	<b>5,5 mm</b>

## Technical details

**Relay outputs**

External contact fuse protection, safety contacts

In accordance with the standard	<b>VDE 0660</b>
Blow-out fuse, quick	<b>10 A</b>
Blow-out fuse, slow	<b>6 A</b>

Switch-off delay **22 ms**Contact material **AgCuNi + 0,2 µm Au**Potential isolation **yes****Environmental data**

Ambient temperature

In accordance with the standard	<b>EN 60068-2-14</b>
Temperature range	<b>0 - 60 °C</b>
Forced convection in control cabinet off	<b>55 °C</b>

Storage temperature

In accordance with the standard	<b>EN 60068-2-1/-2</b>
Temperature range	<b>-25 - 70 °C</b>

Climatic suitability

In accordance with the standard	<b>EN 60068-2-30, EN 60068-2-78</b>
---------------------------------	-------------------------------------

Condensation during operation **Not permitted**Max. operating height above sea level **2000 m**EMC **EN 61131-2**

Vibration

In accordance with the standard	<b>EN 60068-2-6</b>
Frequency	<b>5 - 150 Hz</b>
Acceleration	<b>1g</b>

Shock stress

In accordance with the standard	<b>EN 60068-2-27</b>
Acceleration	<b>15g</b>
Duration	<b>11 ms</b>

Airgap creepage

In accordance with the standard	<b>EN 61131-2</b>
Overvoltage category	<b>II</b>
Pollution degree	<b>2</b>

Protection type

In accordance with the standard	<b>EN 60529</b>
Housing	<b>IP20</b>
Terminals	<b>IP20</b>
Mounting area (e.g. control cabinet)	<b>IP54</b>

**Potential isolation**Potential isolation between **Relay output and system voltage**Type of potential isolation **Protective separation**Rated insulation voltage **250 V**Rated surge voltage **4000 V****Mechanical data**Mounting position **horizontally on mounting rail**

## Technical details

<b>Mechanical data</b>	
Mechanical life	<b>10,000,000 cycles</b>
DIN rail	
Top hat rail	<b>35 x 7,5 EN 50022</b>
Recess width	<b>27 mm</b>
Material	
Bottom	<b>PC</b>
Front	<b>PC</b>
Top	<b>PC</b>
Connection type	<b>Spring-loaded terminal, screw terminal</b>
Mounting type	<b>plug-in</b>
Conductor cross section with screw terminals	
1 core flexible	<b>0,25 - 2,5 mm<sup>2</sup>, 24 - 12 AWG</b>
2 core with the same cross section, flexible without crimp connectors or with TWIN crimp connectors	<b>0,2 - 1,5 mm<sup>2</sup>, 24 - 16 AWG</b>
Torque setting with screw terminals	<b>0,5 Nm</b>
Conductor cross section with spring-loaded terminals: Flexible with/without crimp connector	<b>0,2 - 2,5 mm<sup>2</sup>, 24 - 12 AWG</b>
Spring-loaded terminals: Terminal points per connection	<b>2</b>
Stripping length with spring-loaded terminals	<b>9 mm</b>
Dimensions	
Height	<b>101,4 mm</b>
Width	<b>22,5 mm</b>
Depth	<b>120 mm</b>
Weight	<b>144 g</b>

Where standards are undated, the 2021-09 latest editions shall apply.

## 9.1 Safety characteristic data



### NOTICE

You must comply with the safety characteristic data in order to achieve the required safety level for your plant/machine.

Unit	Operating mode	EN ISO 13849-1: 2015 PL	EN ISO 13849-1: 2015 Category	EN IEC 62061 SIL CL/maximum SIL	EN IEC 62061 PFH <sub>D</sub> [1/h]	EN ISO 13849-1: 2015 T <sub>M</sub> [year]
<b>Logic</b>						
CPU	2-channel	PL e	Cat. 4	SIL 3	2,84E-10	20
<b>Output</b>						
Relay outputs	1-channel	PL c	Cat. 1	-	4,41E-07	20
Relay outputs	2-channel	PL e	Cat. 4	SIL 3	9,58E-11	20

All the units used within a safety function must be considered when calculating the safety characteristic data.



### INFORMATION

A safety function's SIL/PL values are **not** identical to the SIL/PL values of the units that are used and may be different. We recommend that you use the PAScal software tool to calculate the safety function's SIL/PL values.



### CAUTION!

It is essential to consider the relay's service life graphs. The relay outputs' safety-related characteristic data is only valid if the values in the service life graphs are met.

The PFH value depends on the switch frequency and the load of the relay output. If the service life graphs are not accessible, the stated PFH value can be used irrespective of the switch frequency and the load, as the PFH value already considers the relay's B10d value as well as the failure rates of the other components.

## 10 Supplementary data

### 10.1 Service life graph for the relay contacts

The service life graphs indicate the number of cycles from which failures due to wear must be expected. The wear is mainly caused by the electrical load; the mechanical load is negligible.

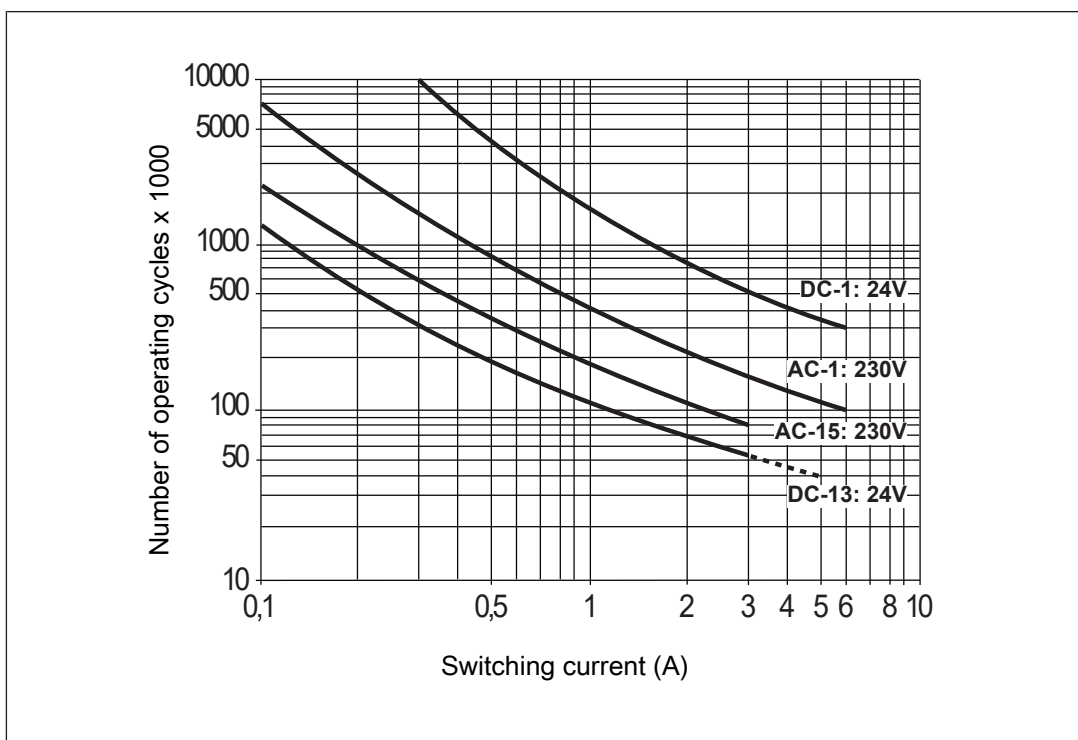

Fig.: Service life graphs at 24 VDC and 230 VAC

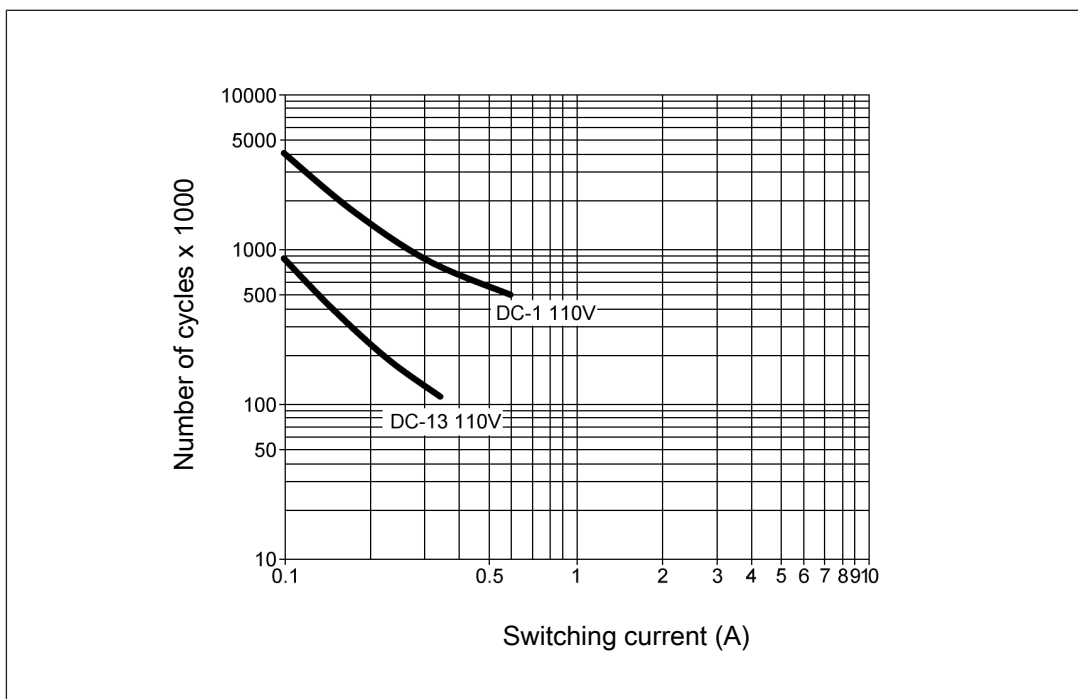



Fig.: Service life graphs at 110 VDC

**Example**

- ▶ Inductive load: 0.2 A
- ▶ Utilisation category: AC15
- ▶ Contact service life: 1 000 000 cycles

Provided the application to be implemented requires fewer than 1 000 000 cycles, the PFH value (see [Technical details](#) [ 19]) can be used in the calculation.

To increase the service life, sufficient spark suppression must be provided on all relay contacts. With capacitive loads, any power surges that occur must be noted. With DC contactors, use flywheel diodes for spark suppression.

We recommend you use semiconductor outputs to switch 24 VDC loads.

Order reference

## 11 Order reference

### 11.1 Product

Product type	Features	Order no.
PNOZ m EF 2DOR	Configurable safe small controllers PNOZmulti 2, expansion module, 2 safe relay outputs.	772146

### 11.2 Accessories

#### Connection terminals

Product type	Features	Order no.
PNOZm spring terminals X1	1 set of spring-loaded terminals	751018
PNOZm screw terminals X1	1 set of screw terminals	750018

#### Terminator, jumper

Product type	Features	Order no.
PNOZ mm0.xp connector left	Jumper yellow/black to connect the modules, 10 piece	779260

## 12 **EC declaration of conformity**

This product/these products meet the requirements of the directive 2006/42/EC for machinery of the European Parliament and of the Council. The complete EC Declaration of Conformity is available on the Internet at [www.pilz.com/downloads](http://www.pilz.com/downloads).

Authorised representative: Norbert Fröhlich, Pilz GmbH & Co. KG, Felix-Wankel-Str. 2, 73760 Ostfildern, Germany

## 13 UKCA-Declaration of Conformity

This product(s) complies with following UK legislation: Supply of Machinery (Safety) Regulation 2008.

The complete UKCA Declaration of Conformity is available on the Internet at [www.pilz.com/downloads](http://www.pilz.com/downloads).

Representative: Pilz Automation Technology, Pilz House, Little Colliers Field, Corby, Northamptonshire, NN18 8TJ United Kingdom, eMail: [mail@pilz.co.uk](mailto:mail@pilz.co.uk)

# ► Support

Technical support is available from Pilz round the clock.

## Americas

### Brazil

+55 11 97569-2804

### Canada

+1 888 315 7459

### Mexico

+52 55 5572 1300

### USA (toll-free)

+1 877-PILZUSA (745-9872)

## Asia

### China

+86 21 60880878-216

### Japan

+81 45 471-2281

### South Korea

+82 31 778 3300

## Australia and Oceania

### Australia

+61 3 95600621

### New Zealand

+64 9 6345350

## Europe

### Austria

+43 1 7986263-0

### Belgium, Luxembourg

+32 9 3217570

### France

+33 3 88104003

### Germany

+49 711 3409-444

### Ireland

+353 21 4804983

### Italy, Malta

+39 0362 1826711

## Scandinavia

+45 74436332

## Spain

+34 938497433

## Switzerland

+41 62 88979-32

## The Netherlands

+31 347 320477

## Turkey

+90 216 5775552

## United Kingdom

+44 1536 462203

## You can reach our international hotline on:

+49 711 3409-222

support@pilz.com

Pilz develops environmentally-friendly products using ecological materials and energy-saving technologies. Offices and production facilities are ecologically designed, environmentally-aware and energy-saving. So Pilz offers sustainability, plus the security of using energy-efficient products and environmentally-friendly solutions.



We are represented internationally. Please refer to our homepage [www.pilz.com](http://www.pilz.com) for further details or contact our headquarters.

Headquarters: Pilz GmbH & Co. KG, Felix-Wankel-Straße 2, 73760 Ostfildern, Germany  
Telephone: +49 711 3409-0, Telefax: +49 711 3409-133, E-Mail: [info@pilz.com](mailto:info@pilz.com), Internet: [www.pilz.com](http://www.pilz.com)

**PILZ**  
THE SPIRIT OF SAFETY



**SCATTERGOOD  
& JOHNSON LTD**  
ELECTRICAL ENGINEERING & FLUID CONTROL DISTRIBUTORS

Est.1899

At Scattergood & Johnson Ltd, we pride ourselves on being a technical distributor to specialist industries.

Working with a range of quality product manufacturers across a number of specialist markets, we are not your average 'box shifter' - we are your technical and supply chain partner.

We fully support every product we sell - for free! Our internal team and external sales engineers can answer any product or application question, no matter the complexity.

Backing up this technical ability is a range of 50,000+ products available from stock for nationwide next day delivery (same day if required!), or you can collect what you need from any of our trade counters around the UK.

Select your specialist interest below to learn more about how we can help.

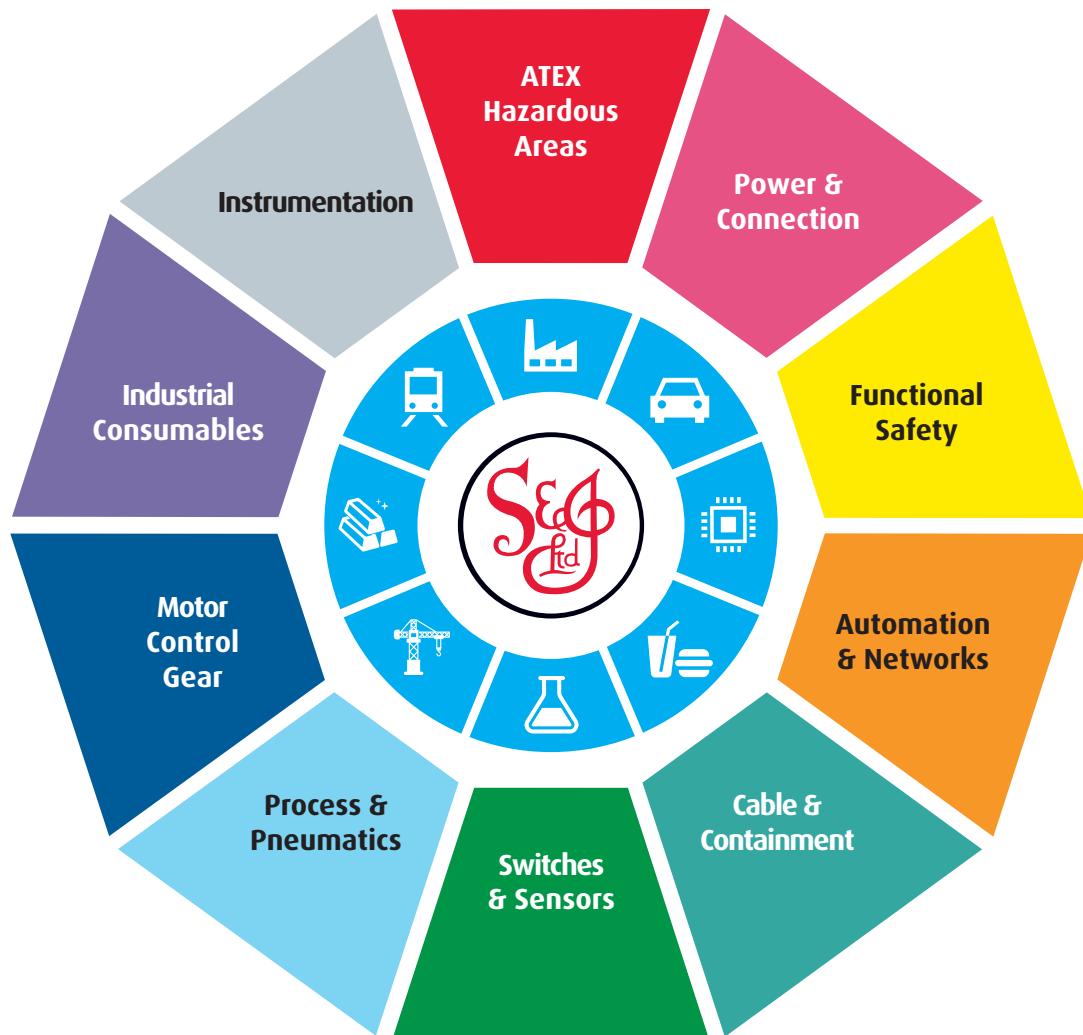

Online, In Branch and On the Road - Scattergood & Johnson Ltd, there when you need us.

**[www.scatts.co.uk](http://www.scatts.co.uk)**