

Retroreflective sensor OBR2500-12GM40-E4

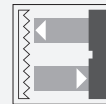

- Robust M12 threaded housing
- Less space required
- Glare protected with polarization filter
- Light-on/dark-on, programmable
- Degree of protection IP67

Retroreflective sensor with polarization filter, M12 threaded housing design, metal housing, front optical face, 5 m detection range, red light, light/dark on, 1 NPN output, fixed cable



Dimensions

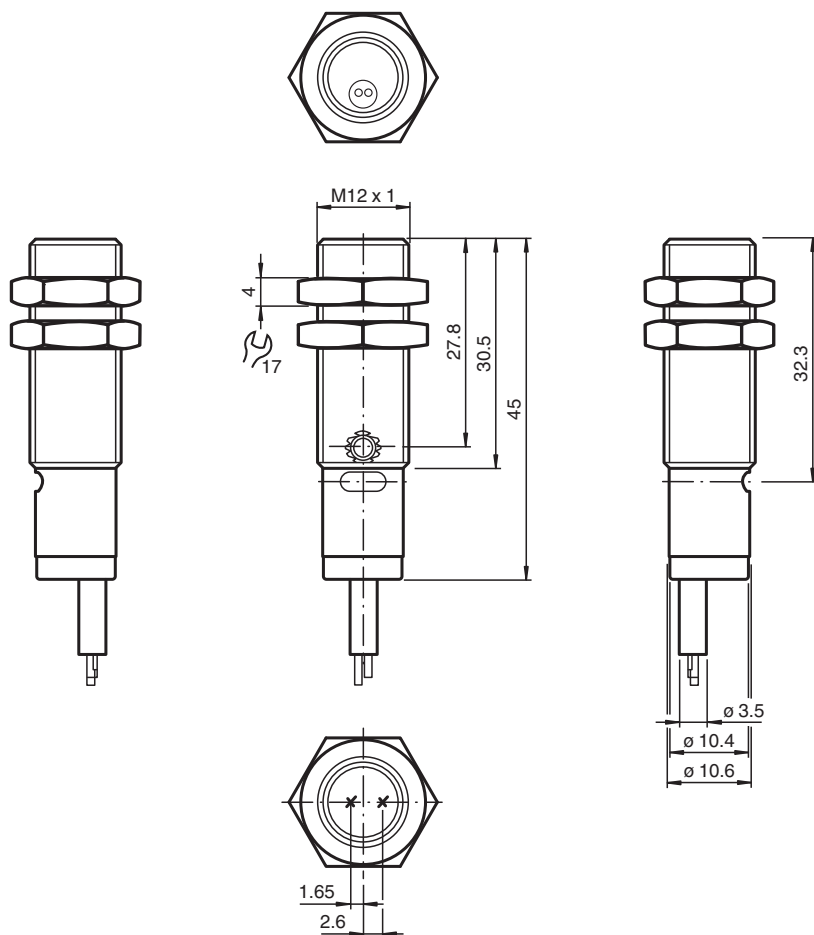

Technical Data

General specifications

Effective detection range 0 ... 2500 mm

Release date: 2023-04-04 Date of issue: 2023-04-04 Filename: 257817_eng.pdf

Refer to "General Notes Relating to Pepperl+Fuchs Product Information".

Pepperl+Fuchs Group
www.pepperl-fuchs.com

USA: +1 330 486 0001
fa-info@us.pepperl-fuchs.com

Germany: +49 621 776 1111
fa-info@de.pepperl-fuchs.com

Singapore: +65 6779 9091
fa-info@sg.pepperl-fuchs.com

PF PEPPERL+FUCHS

Technical Data

Reflector distance		50 ... 2500 mm
Threshold detection range		3000 mm
Reference target		H50 reflector
Light source		LED
Light type		red , 640 nm
Polarization filter		yes
Angle deviation		+/- 2 °
Diameter of the light spot		approx. 150 mm at a distance of 2500 mm
Opening angle		approx. 3.5 °
Optical face		frontal
Ambient light limit		EN 60947-5-2 20000 Lux
Functional safety related parameters		
MTTF _d		800 a
Mission Time (T _M)		20 a
Diagnostic Coverage (DC)		0 %
Indicators/operating means		
Operation indicator		LED green: Power on
Function indicator		LED yellow: lights up when receiving the light beam ; flashes when falling short of the operating reserve; OFF when light beam is interrupted
Control elements		sensitivity adjustment
Electrical specifications		
Operating voltage	U _B	10 ... 30 V DC , class 2
Ripple		10 %
No-load supply current	I ₀	≤ 15 mA
Input		
Control input		light on +UB dark on: 0 V
Output		
Switching type		light/dark on electrically switchable
Signal output		1 NPN output, short-circuit protected, reverse polarity protected, open collector
Switching voltage		max. 30 V DC
Switching current		max. 100 mA , resistive load
Voltage drop	U _d	≤ 2 V
Switching frequency	f	≤ 1000 Hz
Response time		0.5 ms
Conformity		
Product standard		EN 60947-5-2
Compliance with standards and directives		
Standard conformity		
Standards		UL 508
Approvals and certificates		
UL approval		cULus Listed, Class 2 Power Source, Type 1 enclosure
CCC approval		CCC approval / marking not required for products rated ≤36 V
Approvals		CE, cULus Listed 57M3 (Only in association with UL Class 2 power supply; Type 1 enclosure)
Ambient conditions		
Ambient temperature		-30 ... 60 °C (-22 ... 140 °F)
Storage temperature		-40 ... 70 °C (-40 ... 158 °F)
Mechanical specifications		
Degree of protection		IP67
Connection		2 m fixed cable
Material		
Housing		brass, nickel-plated
Optical face		PMMA

Release date: 2023-04-04 Date of issue: 2023-04-04 Filename: 257817_eng.pdf

Refer to "General Notes Relating to Pepperl+Fuchs Product Information".

Pepperl+Fuchs Group
www.pepperl-fuchs.comUSA: +1 330 486 0001
fa-info@us.pepperl-fuchs.comGermany: +49 621 776 1111
fa-info@de.pepperl-fuchs.comSingapore: +65 6779 9091
fa-info@sg.pepperl-fuchs.com

PEPPERL+FUCHS

Technical Data

Mass	approx. 45 g
Cable length	2 m

Connection

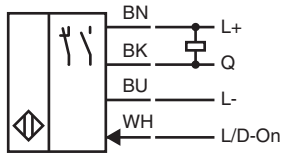

Assembly

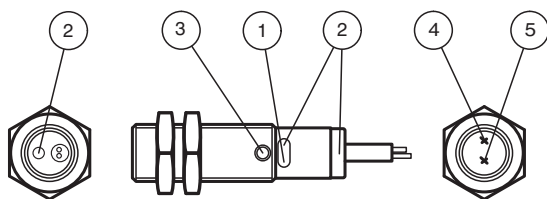

1	Operating display	green
2	Signal display	yellow
3	Potentiometer	
4	Emitter	
5	Receiver	

Relative received light strength

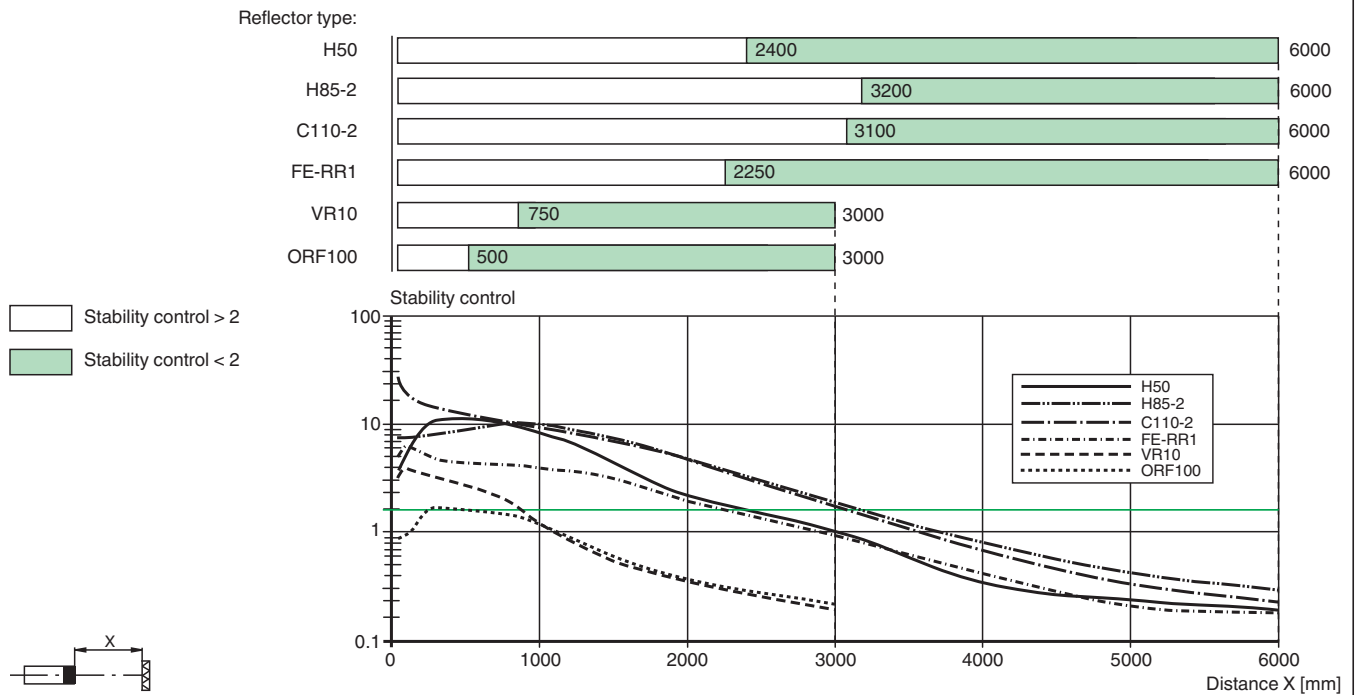

Release date: 2023-04-04 Date of issue: 2023-04-04 Filename: 257817_eng.pdf

Accessories

	BF 12	Mounting flange, 12 mm
	BF 12-F	Plastic mounting adapter, 12 mm

Refer to "General Notes Relating to Pepperl+Fuchs Product Information".







Pepperl+Fuchs Group
www.pepperl-fuchs.com

USA: +1 330 486 0001
fa-info@us.pepperl-fuchs.com

Germany: +49 621 776 1111
fa-info@de.pepperl-fuchs.com

Singapore: +65 6779 9091
fa-info@sg.pepperl-fuchs.com

Accessories

	BF 5-30	Universal mounting bracket for cylindrical sensors with a diameter of 5 ... 30 mm
	REF-H50	Reflector, rectangular 51 mm x 61 mm, mounting holes, fixing strap
	REF-VR10	Reflector, rectangular 60 mm x 19 mm, mounting holes
	REF-H85-2	Reflector, rectangular 84.5 mm x 84.5 mm, mounting holes
	REF-C110-2	Reflector, round \varnothing 84 mm, central mounting hole
	OFR-100/100	Reflective tape 100 mm x 100 mm



**SCATTERGOOD
& JOHNSON LTD**
ELECTRICAL ENGINEERING & FLUID CONTROL DISTRIBUTORS

Est.1899

At Scattergood & Johnson Ltd, we pride ourselves on being a technical distributor to specialist industries.

Working with a range of quality product manufacturers across a number of specialist markets, we are not your average 'box shifter' - we are your technical and supply chain partner.

We fully support every product we sell - for free! Our internal team and external sales engineers can answer any product or application question, no matter the complexity.

Backing up this technical ability is a range of 50,000+ products available from stock for nationwide next day delivery (same day if required!), or you can collect what you need from any of our trade counters around the UK.

Select your specialist interest below to learn more about how we can help.



Online, In Branch and On the Road - Scattergood & Johnson Ltd, there when you need us.

www.scatts.co.uk