

CONTROL TECHNIQUES



MENTOR MP

ENHANCED MOTOR PERFORMANCE AND RELIABILITY
DC DRIVES, HIGH PERFORMANCE

DRIVE OBSESSED

DC DRIVES

MENTOR MP

OPTIMUM PERFORMANCE, FLEXIBLE SYSTEM

The ultimate DC drive

As a world leader in DC drive technology, our innovative products are used in the most demanding applications requiring performance, reliability & energy efficiency.

Mentor MP integrates the control platform from the world's leading intelligent AC drive technology making it the most advanced DC drive available. With optimum performance and flexible system interfacing capability, the Mentor MP drive allows you to maximize motor performance & enhance system reliability. Interface digitally with modern control equipment using Ethernet & fieldbus networks. It is very easy to retrofit from Mentor II & for high power configuration.

Benefits:

- Easy to set-up and commission
- Drive intelligence and system integration
- Machine communications flexibility



MENTOR MP

KEY FEATURES

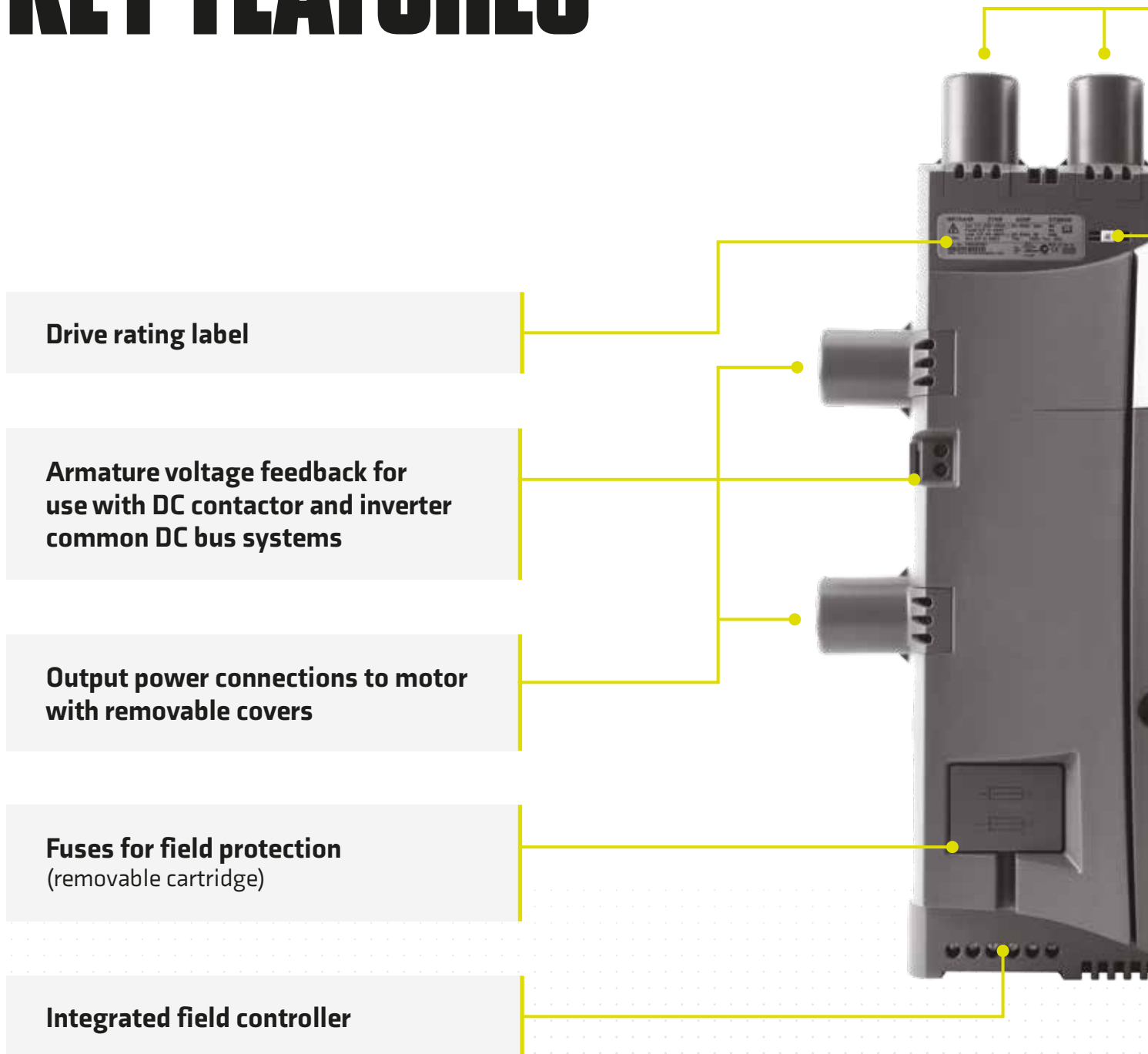



AC supply input connections with removable safety covers

Drive identification marker rail

Optional keypad, available as high brightness LED or multilanguage LCD with plain text

Smartcard for parameter and custom application program storage

Standard onboard Modbus communications port for PC programming & device interfacing

Safety terminal cover

Safety finger guard

MENTOR MP

KEY FEATURES

Communications port for external field controller

Sturdy cable management system providing a grounding point for shielded control cables



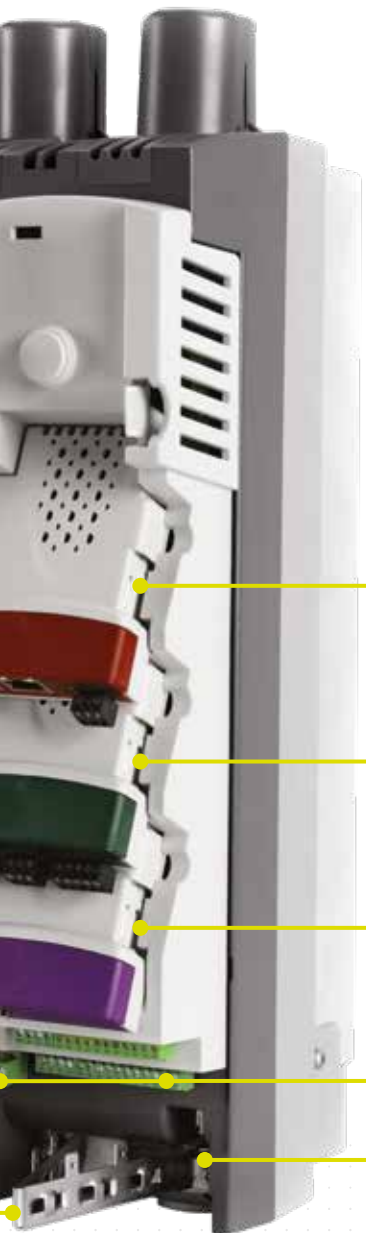

3 universal option module slots for communications, I/O, additional feedback devices and automation / motion controllers

Pluggable terminals for I/O, relays, tacho feedback, encoder and a current feedback test pin for fine tuning armature current loop

Communication ports for paralleling drives (Size 2 only)

EASY SET-UP OF ENHANCED CONTROL AND MONITORING

Greater motor field control

Built in field controller as standard

- Gives excellent field control for the majority of DC motors
- Reduces the need for external components

Enhanced system design

- The heatsink cooling fans are intelligently controlled and only run when required, thus increasing reliability and reducing maintenance
- Eighteen different option modules allow customisation of the drive, including fieldbus, Ethernet, I/O, extra feedback devices and motion controllers
- The drive system designer is able to embed automation and motion control within the drive, eliminating communications delays that reduce performance

Enhanced field control with FXMP25

- The FXMP25 may be controlled digitally by using a standard RJ45 connection, allowing set-up by standard drive parameters
- The FXMP25 can also function in standalone mode using its integrated keypad and display

Fast set-up, configuration and monitoring

- Quick and easy to set-up
- Can be configured using optional removable keypads
- Advanced auto-tune features help you get the best performance from your machine



PC SOFTWARE & SMARTCARD TOOLS: RAPID COMMISSIONING

Control Techniques' software makes it easy to access the drive's feature set. It allows you to optimize drive tuning, back-up the configuration and set-up a communications network.

CTScope

Drive oscilloscope software for viewing & analysing changing values within the drive.

- The time base can be set to give high speed capture for tuning or for longer term trends
- Based on a traditional oscilloscope, making it easy to use for all engineers

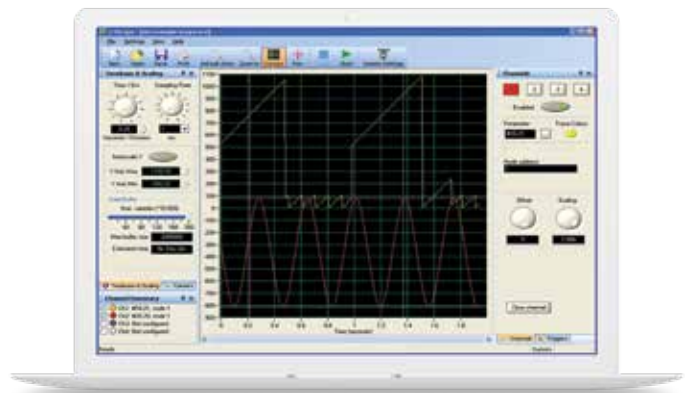

Smartcard

The smartcard is a backup memory device that brings the following benefits:

- Parameter and program storage
- Simplify drive maintenance and commissioning
- Quick set-up for sequential build of machines
- Machine upgrades can be stored on a smartcard & sent to the customer for installation



CTSoft

Our drive configuration tool for commissioning, optimising and monitoring allows you to:

- Use configuration wizards to commission your drive
- Read, save and load drive configuration settings
- Manage the drive's smartcard data
- Visualize and modify the configuration with live animated diagrams
- All motor data is entered in real units and the current limit window will calculate parameter settings based on ambient temperature and required overload rating



Unrivalled integration flexibility

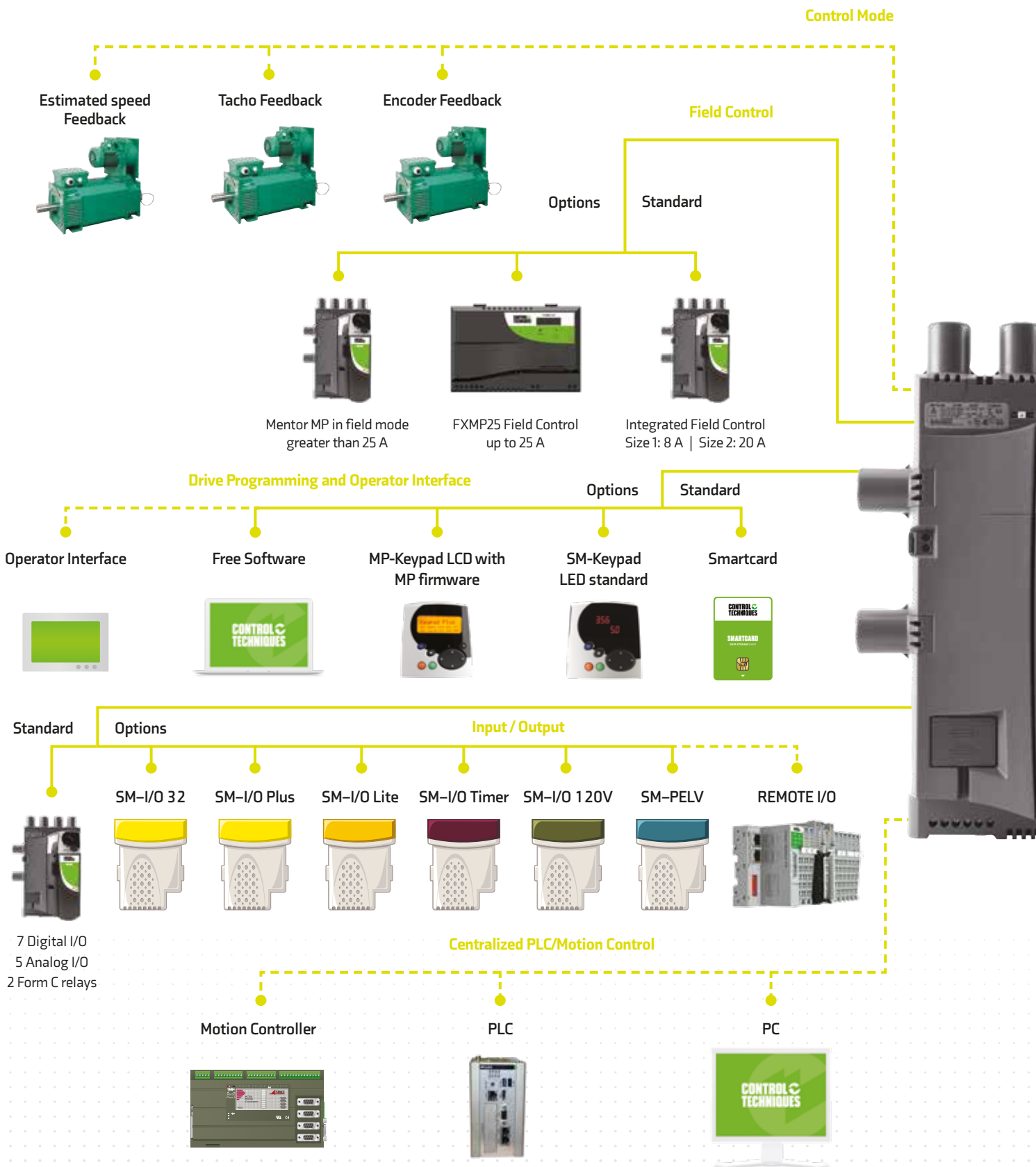

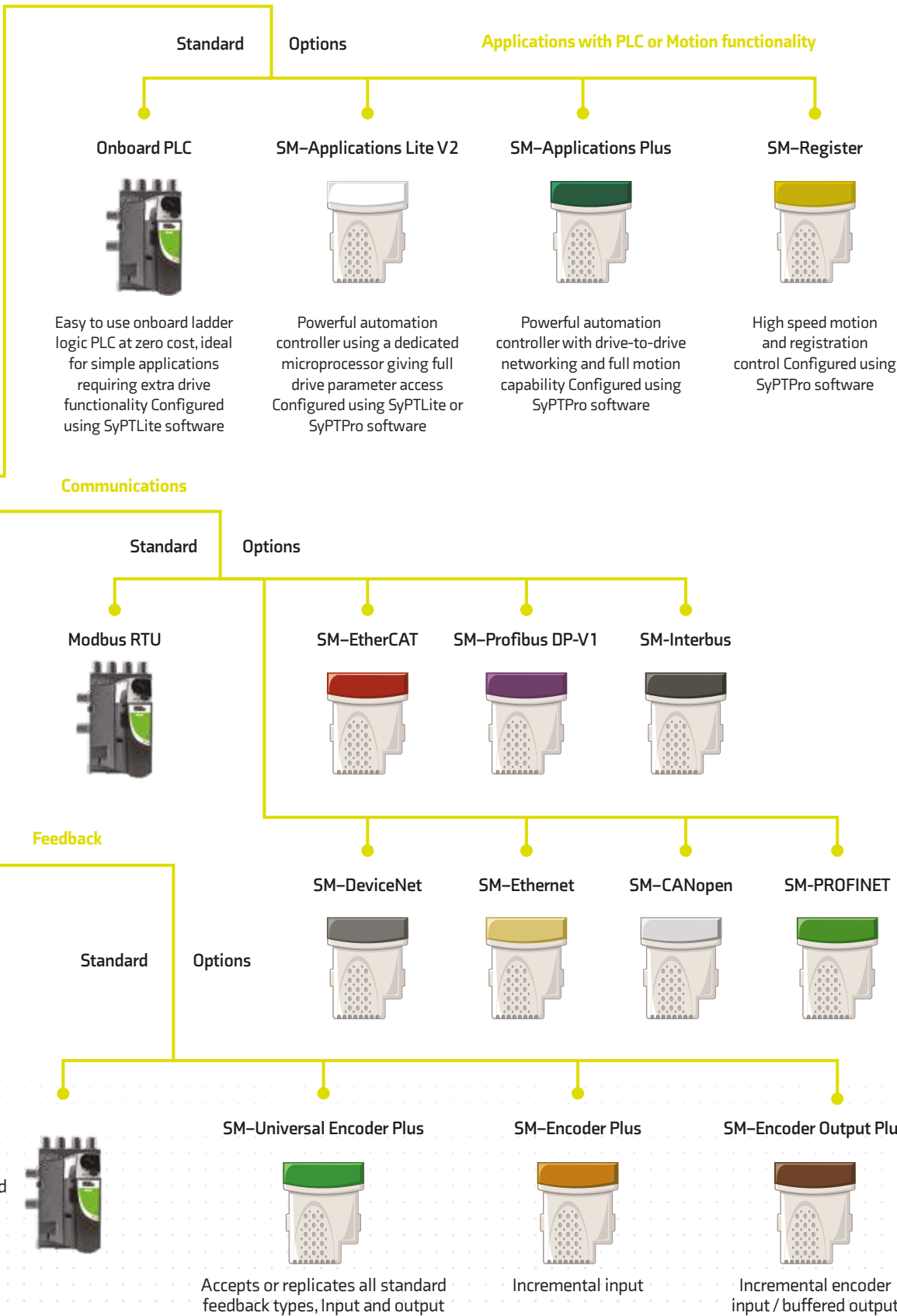

MENTOR MP

DRIVE INTELLIGENCE

& SYSTEM INTEGRATION

Inbuilt controller programmable with SyPTLite

- Mentor MP has an inbuilt programmable controller. It is configured using SyPTLite, an easy to use ladder logic program editor, suitable for replacing relay logic or a micro PLC for simple drive control applications.

Develop tailored solutions for applications modules with SyPTPro

- SyPTPro is a fully featured automation development environment that can be used for developing tailored solutions for single or multiple drive applications.
- The programming environment fully supports three industry standard languages: Function Block, Ladder and Structured Text. Motion control is configured using the new PLCopen motion language, supporting multiple axes.

Create an intelligent networked system with CTNet

- CTNet, a high-speed, deterministic drive-to-drive network links the drives, SCADA and I/O together to form an intelligent networked system, with SyPTPro managing both the programming and communications.



SyPTLite

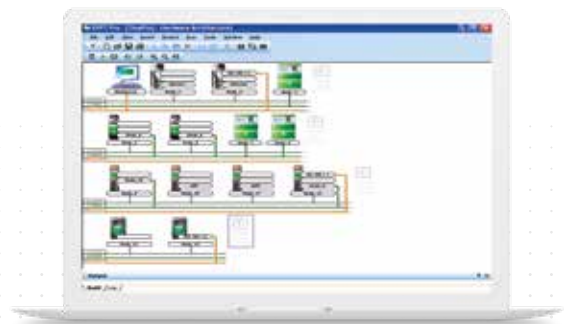

SyPTPro



High performance automation

Control Techniques' SM-Applications option modules contain a separate high performance microprocessor enabling the execution of application programs. This leaves the drive's own processor to give the best possible motor performance.

The SM-Application modules include the SM-Application Plus and the SM-Application Lite V2 variants.

- Both modules can be used to tackle automation problems from simple start/stop sequencing with a single drive to more complex machine and motion control application.
- The SM-Applications modules give you real-time access to all of the drive's parameters, plus access to data from I/O and other drives.

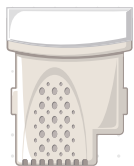

SM-Applications Lite V2



SM-Applications Plus

SM-Applications Plus adds:

- Inputs/Outputs – The module has two digital inputs and two digital outputs for high-speed I/O operations such as position capture and actuator firing.
- High speed serial port – The module features a serial communications port supporting a number of built-in protocols for connection to external devices such as operator interface panels. These are CT-ANSI slave,
- Modbus RTU in master and slave modes, Modbus ASCII in master and slave modes and 3 user modes. Both two and four wire configurations are possible.
- Drive-to-drive communications – SM-Applications Plus option modules include a high speed drive-to-drive network called CTNet. This network is optimized for intelligent drive systems offering flexible peer-to-peer communications.



MENTOR MP MACHINE COMMUNICATIONS FLEXIBILITY

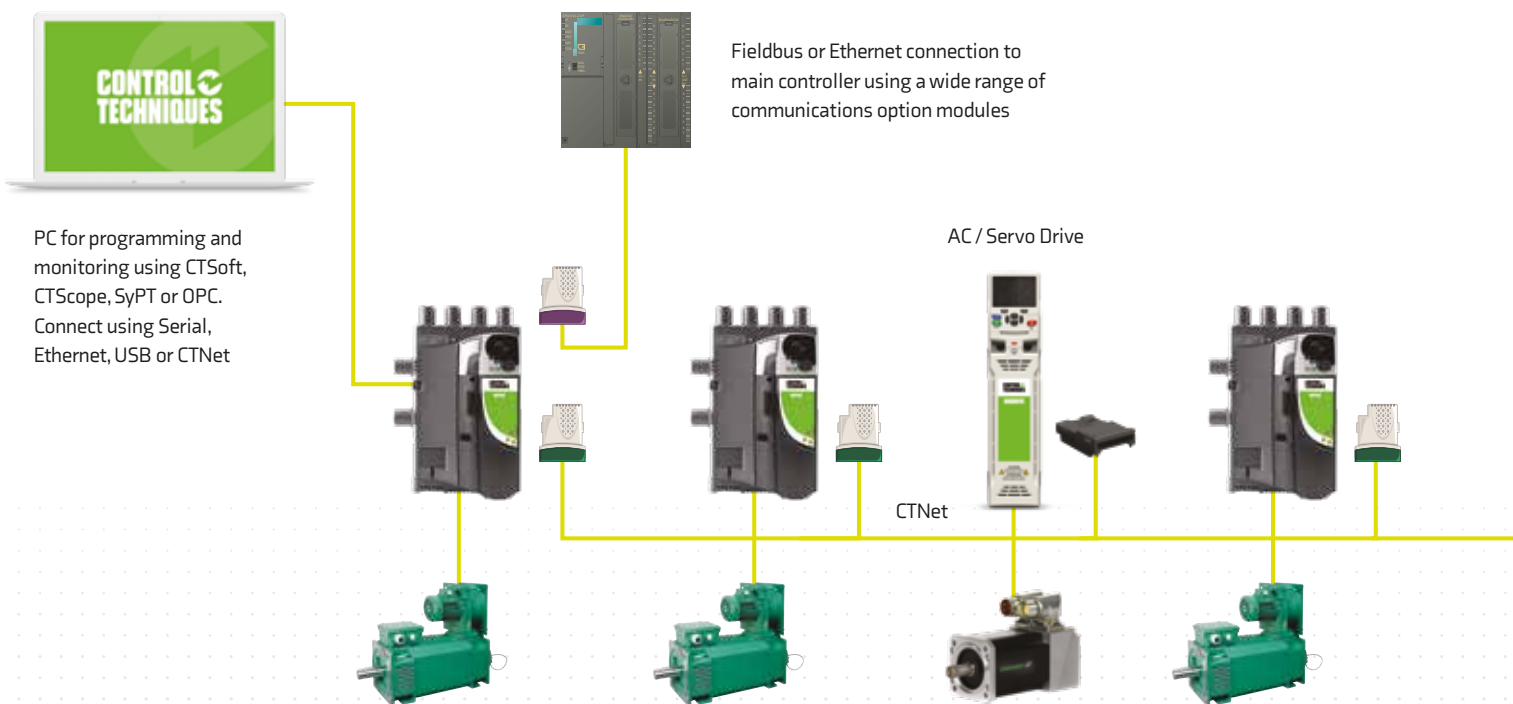



Fieldbus communications

Option modules for all common Industrial Ethernet fieldbus networks such as Ethernet IP & ProfiNet. Servo networks such as Ethercat are also available.

Easy gateway

SM-Applications & CNet allow machine designers to design an easy gateway into which customers are able to interface using their preferred fieldbus or Ethernet interface. This solution improves the machine performance, simplifies the problem of being able to meet customer specifications for different fieldbus communications & helps to protect your intellectual property.

	Onboard PLC	SM-Applications Lite V2	SM-Applications Plus
Intellectual property protection	●	●	●
SyPTLite Programming	●	●	
SyPTPro Programming		●	●
Multi-tasking environment		●	●
Motion control capabilities		●	●
CNet drive-to-drive network			●
Serial port			●
High Speed I/O			●

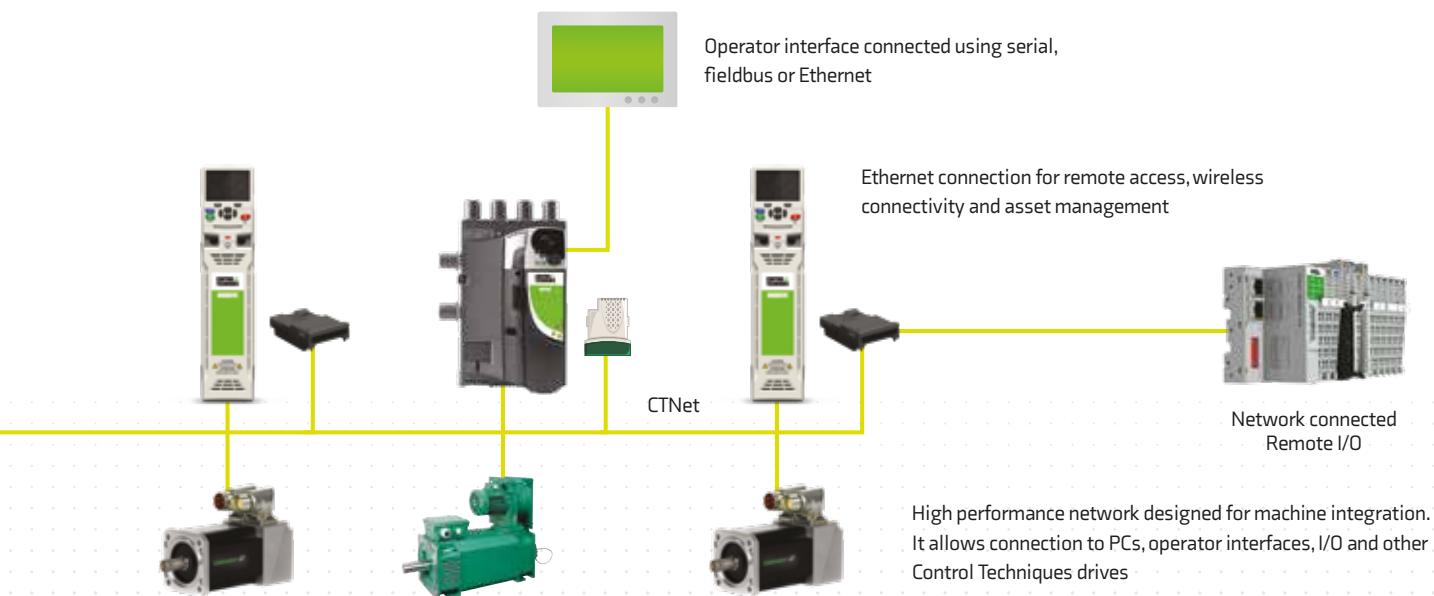

PERFORM BETTER

MENTOR MP

SECURE PLANT

AVAILABILITY

Mentor II has had its day and the simplest way to secure plant availability is to level up with Mentor MP.

Retro-fit projects

- We ensure easy integration with your existing motor, power supply, application equipment and communication networks from the design stage
- Mentor MP brings performance and possibilities to your application with minimum migration costs

Motor field control

- Built in field controller as standard in every Mentor MP
 - i. Gives excellent field control for the majority of DC motors
 - ii. Reduces the need for external components

We recommend an external motor field controller when:

- The required field current is greater than that offered by the standard drive, up to 25 A. For example, older motors with low field voltages
- The field needs to be forced down more quickly than a standard half controlled field bridge can manage
- Applications can be implemented with simple field current reversal, without armature reversal, if machine dynamics can still be met

Ease of migration

- Mentor MP is designed for existing Mentor II customers to easily migrate to the new platform
- All power terminal locations and mounting points have been retained
- At 900 A, Mentor MP has a much smaller frame size than Mentor II with smaller cable requirements. This allows for high power density paralleled configurations without custom-made bus bars.
- CT Soft has a built in migration wizard to assist with the transfer of drive parameters and programs.

Note:

The control section of Mentor MP frame 2C and 2D is 90 mm deeper than Mentor II.

If a depth extension is not possible, then for other solutions, please contact your Control Techniques supplier.

MENTOR MP HIGH POWER CONFIGURATION

For higher armature currents and harmonic minimization the Mentor MP has standard features to enable the configurations below to be implemented.

When paralleling the Mentor MP a 5% armature current de-rating must be applied. Up to 7030 A can be controlled.

Parallel - 6 pulse

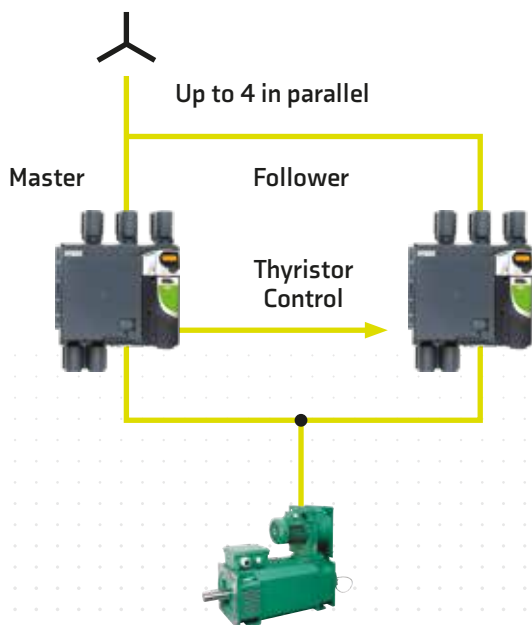

Parallel - 12 pulse

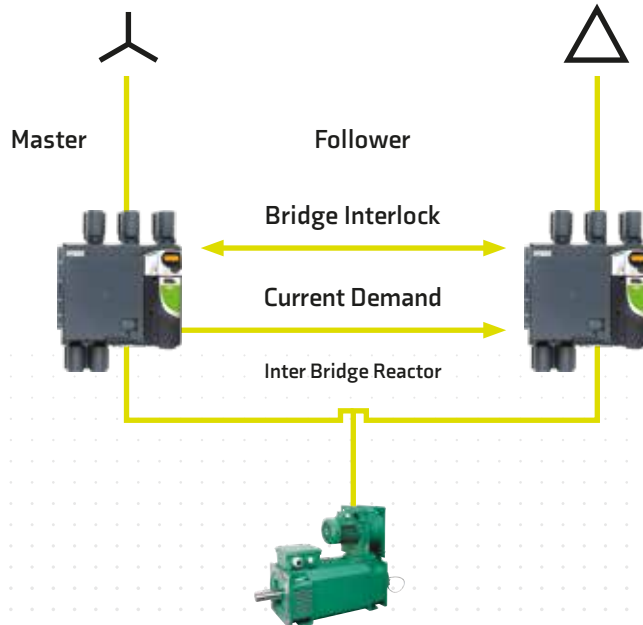



Parallel - 24 pulse

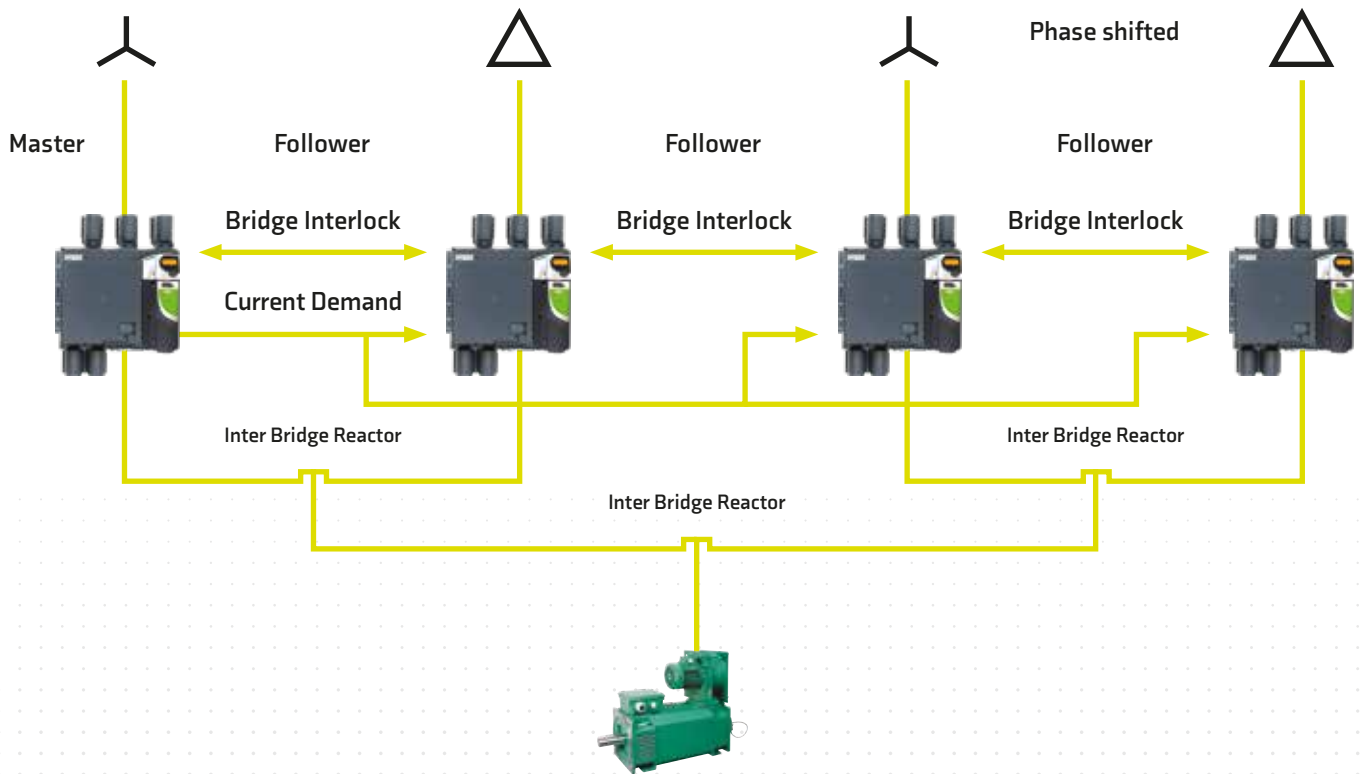

DC MOTOR SOLUTIONS

QUALITY & TECHNOLOGY

LEADERSHIP

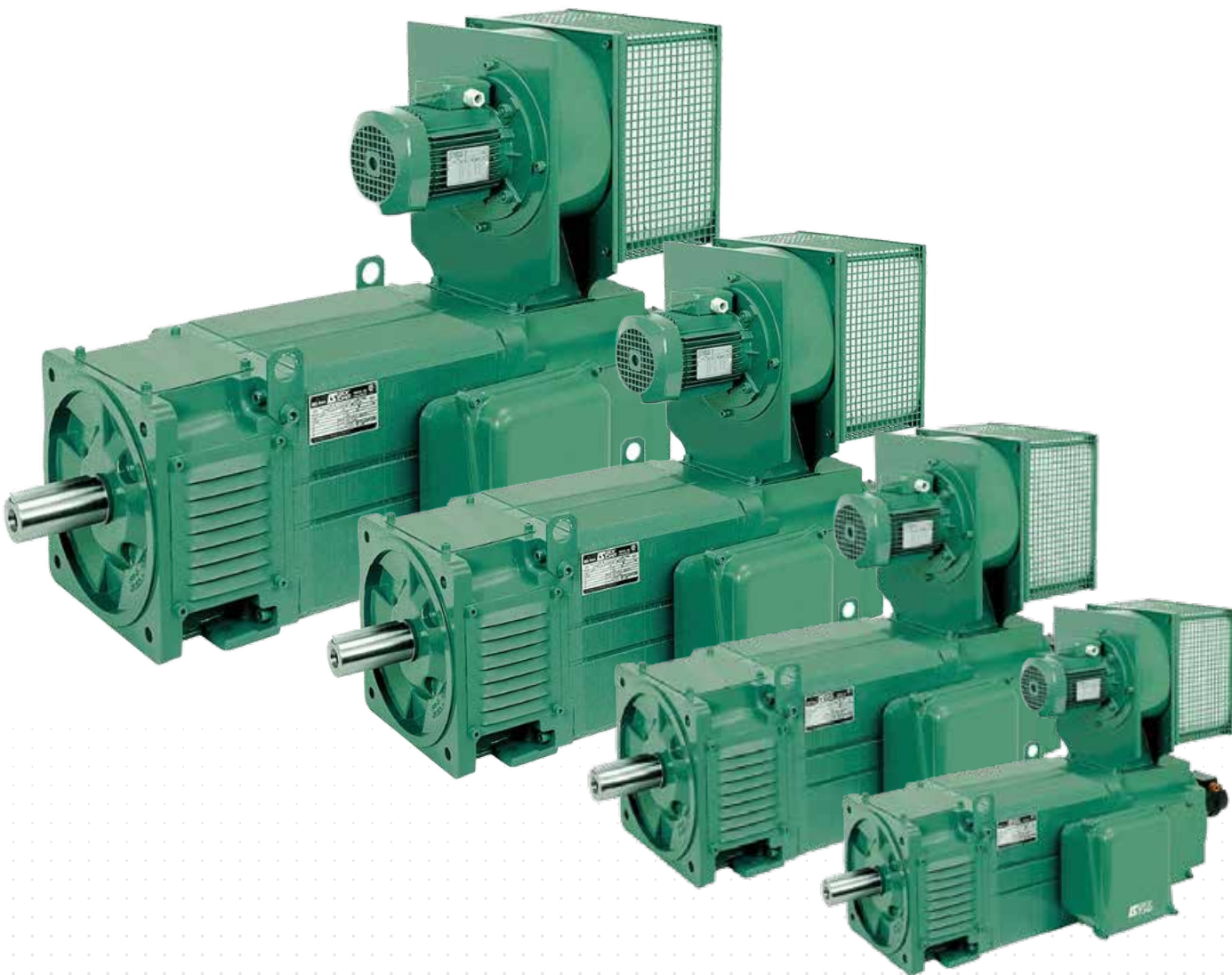



Motor and drive solutions

Control Techniques Mentor MP DC drives and Leroy-Somer DC motors offer a total solution. Both companies offer quality and technology leadership to deliver the best possible combination of motors and drives. High efficiency DC motors combined with variable speed control offers a matched energy optimized solution.

Higher power DC motors

Control Techniques has access to several other ranges of DC motors, allowing us to cover the complete power range of Mentor MP DC drives.

Leroy-Somer LSK square frame DC motors:

- 2 – 750 kW (3 – 1,000 hp)
- 50 – 6,600 Nm (82.6 – 4,867.3 lb ft)
- Frame size: 112 – 355 mm (4.4 – 14 in)
- IP23S, IP44R, IP55R, IP55 with exchangers
- S1 duty
- PTC thermistors
- IC06 forced vent cooling with standard polyester filter
- Class H insulation
- 3-phase full bridge supply
- Terminal box in any position
- Forced vent top
- Tacho type RE0444
- Incremental quadrature encoders/frequency and direction encoders

MENTOR MP

TECHNICAL DATA

Conformance

- Humidity 95 % maximum (non condensing) at 40 °C (104 °F)
- Ambient temperature -15 °C to +40 °C (5 °F to +104 °F), 55 °C (131 °F) with derating
- Altitude: 0 to 3000 m, derate 1 % per 100 m between 1000 m and 3000 m
- Vibration: Tested in accordance with IEC 60068-2-64
- Mechanical shock tested in accordance with IEC 60068-2-29
- Storage temperature -40 °C to +70 °C (-40 °F to +158 °F)
- Notch Immunity to IEC60146-1-1 class A
- Electromagnetic immunity complies with EN 61800-3 and EN 61000-6-2
- IEC 61800-5-1 Electrical safety
- IEC 61131-2 I/O
- EN 60529 Ingress protection
- UL508C
- EN 61000-6-4 EMC - with optional EMC filters
- RoHS compliant



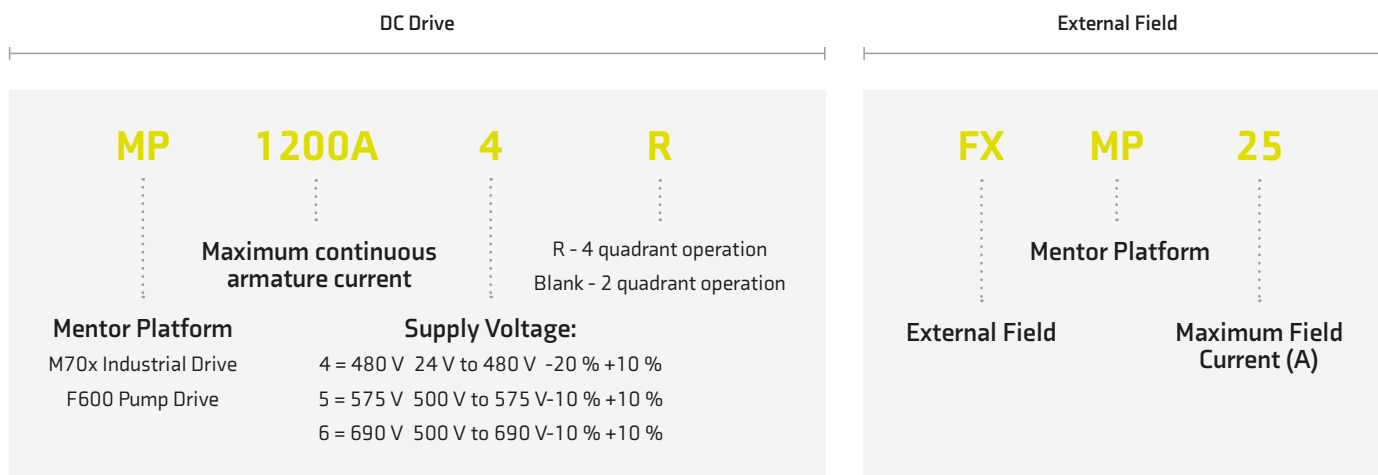

Note: At the time of ordering, please select the required interface option.

Model			Frame	Armature current (A)*	Field current (A)	Overall dimensions			Quadrants of Operation
480V EN / IEC cULus	575V EN / IEC cULus to 600V	690V EN / IEC				Width (W)	Height (H)	Depth (D)	
MP25A4(R)	MP25A5(R)			25	8	293mm (11.54in)	444mm (17.48in)	222mm (8.74in)	2 and 4
MP45A4(R)	MP45A5(R)		1A	45					
MP75A4(R)	MP75A5(R)			75					
MP105A4(R)	MP105A5(R)			105					
MP155A4(R)	MP155A5(R)		1B	155	20	293mm (11.54in)	444mm (17.48in)	251mm (9.88in)	2 and 4
MP210A4(R)	MP210A5(R)			210					
MP350A4(R)	MP350A5(R)	MP350A6(R)		350					
MP420A4(R)	MP470A5(R)	MP470A6(R)	2A	420 470**					
MP550A4(R)				550	20	495mm (19.49in)	640mm (25.20in)	301mm (11.85in)	2 and 4
MP700A4(R)	MP700A5(R)	MP700A6(R)		700					
MP825A4(R)	MP825A5(R)	MP825A6(R)	2B	825**					
MP900A4(R)				900					
MP1200A4	MP1200A5	MP1200A6	2C	1200	20	555mm (21.85in)	1050mm (41.34in) ***	611mm (24.06in)	2
MP1850A4	MP1850A5	MP1850A6		1850					
MP1200A4R	MP1200A5R	MP1200A6R	2D	1200					
MP1850A4R	MP1850A5R	MP1850A6R		1850					

7030 A is achieved by parallel connection of Mentor MP drives

* Current ratings are at 40°C with 150% overload for 30s.

** For this rating at 575V and 690V, 150% overload time is 20s at 40°C and 30s at 35°C.

*** Height including optional fit exhaust duct cover is 1252mm (49.29in) for size 2C and 1712mm (67.40in) for size 2D.

DRIVE OBSESSED



Control Techniques has been designing and manufacturing the best variable speed drives in the world since 1973.

Our customers reward our commitment to building drives that outperform the market. They trust us to deliver on time every time with our trademark outstanding service.

More than 45 years later, we're still in pursuit of the best motor control, reliability and energy efficiency you can build into a drive. That's what we promise to deliver, today and always.

1.5K+

Employees

70

Countries

#1 FOR ADVANCED MOTOR AND DRIVE TECHNOLOGY



Nidec Corporation is a global manufacturer of electric motors and drives.

Nidec was set up in 1973. The company made small precision AC motors and had four employees. Today, it's a global corporation that develops, builds and installs cutting-edge drives, motors and control systems in over 70 countries with a workforce of more than 110,000.

You'll find its innovations in thousands of industrial plants, IoT products, home appliances, cars, robotics, mobile phones, haptic devices, medical apparatus and IT equipment all over the world.

112K

Employees

\$14.2B

Group Turnover

44+

Countries

337+

Companies



CONTROL TECHNIQUES.
NO ONE KNOWS DRIVES LIKE WE DO.

Our drive obsessive representatives will drive you in the right direction and give you first class support whenever you need it.

For more information, or to find your local drive centre, visit:

www.controltechniques.com
www.driveobsessed.com

Connect with us



©2022 Nidec Control Techniques Limited. The information contained in this brochure is for guidance only and does not form part of any contract. The accuracy cannot be guaranteed as Nidec Control Techniques Ltd have an ongoing process of development and reserve the right to change the specification of their products without notice.

Nidec Control Techniques Limited. Registered Office: The Gro, Newtown, Powys SY16 3BE.

Registered in England and Wales. Company Reg. No. 01236886.

0776-0000-11 01/22





**SCATTERGOOD
& JOHNSON LTD**
ELECTRICAL ENGINEERING & FLUID CONTROL DISTRIBUTORS

Est.1899

At Scattergood & Johnson Ltd, we pride ourselves on being a technical distributor to specialist industries.

Working with a range of quality product manufacturers across a number of specialist markets, we are not your average 'box shifter' - we are your technical and supply chain partner.

We fully support every product we sell - for free! Our internal team and external sales engineers can answer any product or application question, no matter the complexity.

Backing up this technical ability is a range of 50,000+ products available from stock for nationwide next day delivery (same day if required!), or you can collect what you need from any of our trade counters around the UK.

Select your specialist interest below to learn more about how we can help.

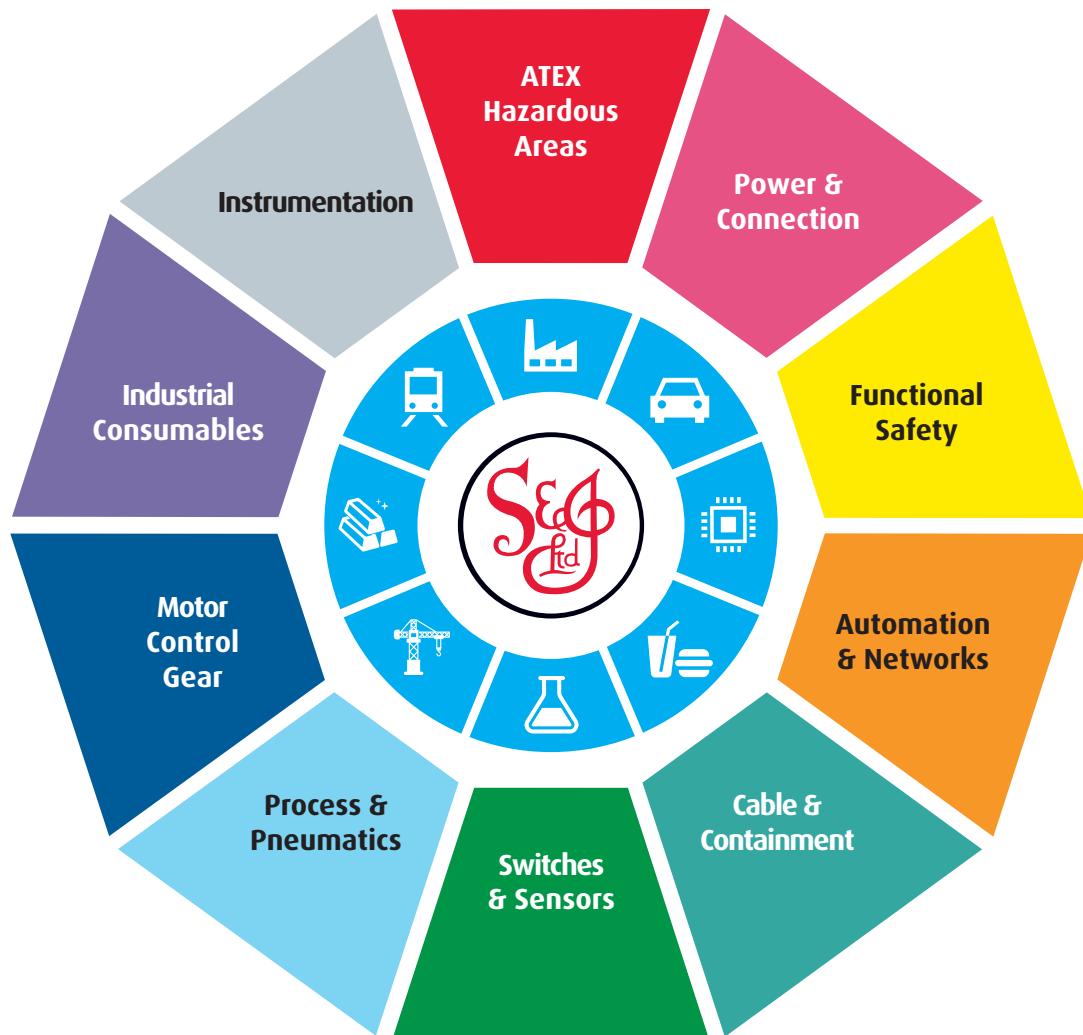

Online, In Branch and On the Road - Scattergood & Johnson Ltd, there when you need us.

www.scatts.co.uk