



Power contactor
BF160

Product designation

Product type designation

Contact characteristics

Number of poles	Nr.	3
Rated insulation voltage U_i IEC/EN	V	1000
Rated impulse withstand voltage U_{imp}	kV	8
Operational frequency	min	Hz 25
	max	Hz 400
IEC Conventional free air thermal current I_{th}	A	250
Operational current I_e	AC-1 (=40°C)	A 250
	AC-1 (=55°C)	A 210
	AC-1 (=70°C)	A 180
	AC-3 (=440V =55°C)	A 160
	AC-4 (400V)	A 75
Rated operational power AC-3 (T=55°C)	230V	kW 45
	400V	kW 75
	415V	kW 90
	440V	kW 90
	500V	kW 110
	690V	kW 132
	1000V	kW 75
Rated operational power AC-1 (T=40°C)	230V	kW 95
	400V	kW 165
	500V	kW 181
	690V	kW 284
IEC max current I_e in DC1 with L/R = 1ms with 1 poles in series	=24V	A 250
	48V	A 250
	75V	A 250
	110V	A 110
	220V	A -
IEC max current I_e in DC1 with L/R = 1ms with 2 poles in series	=24V	A 250
	48V	A 250
	75V	A 250
	110V	A 150
	220V	A 130
IEC max current I_e in DC1 with L/R = 1ms with 3 poles in series	=24V	A 250
	48V	A 250
	75V	A 250

	110V	A	160
	220V	A	150
	330V	A	130
<hr/>			
IEC max current Ie in DC1 with L/R = 1ms with 4 poles in series	=24V	A	250
	48V	A	250
	75V	A	250
	110V	A	250
	220V	A	250
<hr/>			
IEC max current Ie in DC3-DC5 with L/R = 15ms with 1 poles in series	=24V	A	250
	48V	A	250
	75V	A	160
	110V	A	80
	220V	A	–
<hr/>			
IEC max current Ie in DC3-DC5 with L/R = 15ms with 2 poles in series	=24V	A	250
	48V	A	250
	75V	A	160
	110V	A	120
	220V	A	90
<hr/>			
IEC max current Ie in DC3-DC5 with L/R = 15ms with 3 poles in series	=24V	A	250
	48V	A	250
	75V	A	160
	110V	A	140
	220V	A	120
	330V	A	90
<hr/>			
IEC max current Ie in DC3-DC5 with L/R = 15ms with 4 poles in series	=24V	A	250
	48V	A	250
	75V	A	160
	110V	A	140
	220V	A	140
	330V	A	140
	460V	A	90
<hr/>			
Short-time allowable current for 10s (IEC/EN60947-1)		A	1280
<hr/>			
Protection fuse	gG (IEC)	A	315
	aM (IEC)	A	200
<hr/>			
Making capacity (RMS value)		A	1360
<hr/>			
Breaking capacity at voltage	440V	A	1360
	500V	A	1326
	690V	A	1139
<hr/>			
Resistance per pole (average value)		m?	0.18
<hr/>			
Power dissipation per pole (average value)	Ith	W	11
	AC3	W	4.5
<hr/>			
Tightening torque for terminals	min	Nm	18
	max	Nm	18
	min	Ibin	159
	max	Ibin	159

Tightening torque for coil terminal

min	Nm	0.8
max	Nm	1

Power terminal protection according to IEC/EN 60529

IP00

Mechanical features

Operating position

normal	Vertical plan
allowable	±30°

Fixing

Screw

Weight

g	3000
---	------

Operations

Mechanical life

cycles	10000000
--------	----------

Electrical life

cycles	1000000
--------	---------

Safety related data

Performance level B10d according to EN/ISO 13489-1

rated load	cycles	1000000
------------	--------	---------

EMC compatibility

yes

AC coil operating

Rated AC voltage at 50/60Hz, 60Hz

min	V	24
max	V	60

AC operating voltage

of 50/60Hz coil powered at 50Hz
pick-up

min	%Us	80 Us min
max	%Us	110 Us max

drop-out

max	%Us	=70 Us min
-----	-----	------------

of 50/60Hz coil powered at 60Hz
pick-up

min	%Us	80 Us min
max	%Us	110 Us max

drop-out

max	%Us	=70 Us min
-----	-----	------------

AC average coil consumption at 20°C

of 50/60Hz coil powered at 50Hz

in-rush	VA	160...230
holding	VA	1.5...3.0

of 50/60Hz coil powered at 60Hz

in-rush	VA	160...230
holding	VA	1.5...3.0

of 60Hz coil powered at 60Hz

in-rush	VA	160...230
holding	VA	1.5...3.0

Dissipation at holding =20°C 50Hz

W	1.5...3.0
---	-----------

DC coil operating

DC rated control voltage

min	V	20
max	V	60

DC operating voltage

pick-up

min	%Us	85 Us min
max	%Us	110 Us max

drop-out			
	max	%Us	=70 Us min
Average coil consumption =20°C			
	in-rush	W	160...230
	holding	W	1.5...3.0
Max cycles frequency			
Mechanical operation		cycles/h	1000
Operating times			
Average time for Us control			
in AC			
Closing NO			
	min	ms	50
	max	ms	100
Opening NO			
	min	ms	35
	max	ms	75
UL technical data			
Yielded mechanical performance			
for three-phase AC motor			
	200/208V	HP	50
	220/230V	HP	60
	460/480V	HP	125
	575/600V	HP	150
General USE			
Contactor			
	AC current	A	250
Short-circuit protection fuse, 600V			
High fault			
	Short circuit current	kA	100
	Fuse rating	A	400
	Fuse class		J
Standard fault			
	Short circuit current	kA	10
	Fuse rating	A	400
	Fuse class		RK5
Ambient conditions			
Temperature			
Operating temperature			
	min	°C	-40
	max	°C	70
Storage temperature			
	min	°C	-50
	max	°C	80
Max altitude		m	3000
Resistance & Protection			
Pollution degree			3
Dimensions			

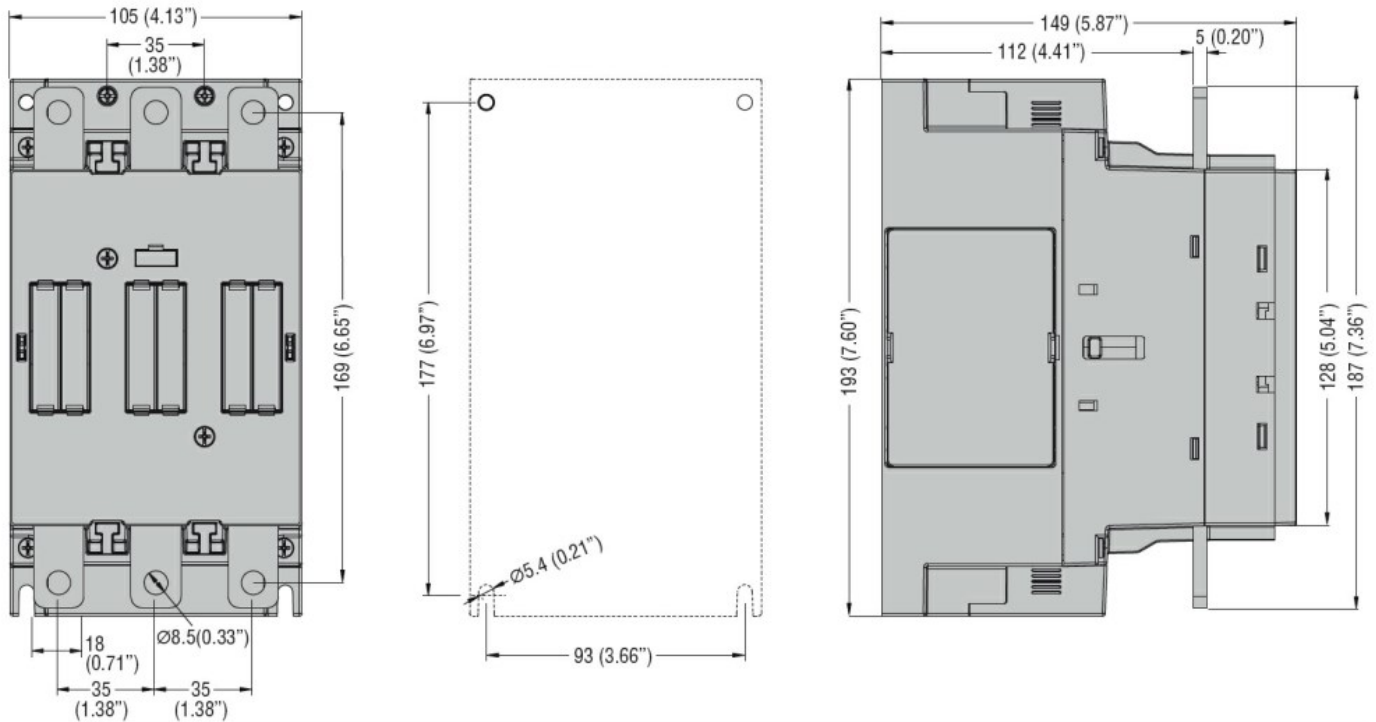

Wiring diagrams

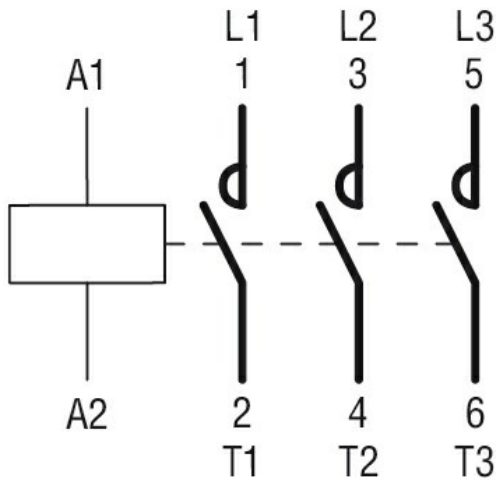

Certifications and compliance

Compliance

CSA C22.2 n° 60947-1
CSA C22.2 n° 60947-4-1
IEC/EN/BS 60947-1
IEC/EN/BS 60947-4-1
UL 60947-1
UL 60947-4-1

Certificates

cULus

ETIM classification

ETIM 8.0

EC000066 -
Power contactor,
AC switching