



WL12-3P2431

W12-3

SMALL PHOTOELECTRIC SENSORS

SICK
Sensor Intelligence.



Illustration may differ



Ordering information

| Type | Part no. |
|-------------|----------|
| WL12-3P2431 | 1041436 |

Included in delivery: BEF-KH-W12 (2)

Other models and accessories → www.sick.com/W12-3

Detailed technical data

Features

| | |
|------------------------------------|---------------------------------------|
| Functional principle | Photoelectric retro-reflective sensor |
| Functional principle detail | Autocollimation |
| Sensing range max. | 0 m ... 7 m ¹⁾ |
| Sensing range | 0 m ... 5 m ¹⁾ |
| Polarisation filters | Yes |
| Emitted beam | |
| Light source | LED ²⁾ |
| Type of light | Visible red light |
| Light spot size (distance) | Ø 100 mm (3 m) |
| Key LED figures | |
| Wave length | 640 nm |
| Adjustment | Potentiometer, 5 turns |
| Angle of dispersion | Approx. 1.5° |
| Items supplied | 2 x clamps BEF-KH-W12, incl. screws |

¹⁾ Reflector PL80A.

²⁾ Average service life: 100,000 h at T_J = +25 °C.

Safety-related parameters

| | |
|-------------------------|-------------|
| MTTF_D | 1,543 years |
| DC_{avg} | 0 % |

Electrical data

| | |
|--|---|
| Supply voltage U_b | 10 V DC ... 30 V DC ¹⁾ |
| Ripple | < 5 V _{pp} ²⁾ |
| Current consumption | 30 mA ³⁾ |
| Protection class | III |
| Digital output | |
| Type | PNP |
| Signal voltage PNP HIGH/LOW | > U _v - 2,5 V / ca. 0 V |
| Output current I _{max.} | ≤ 100 mA |
| Response time | ≤ 330 μs ⁴⁾ |
| Switching frequency | 1,500 Hz ⁵⁾ |
| Switching mode | Light/dark switching |
| Output function | Complementary |
| Circuit protection | A ⁶⁾ C ⁷⁾ D ⁸⁾ |

¹⁾ Limit values when operated in short-circuit protected network: max. 8 A.

²⁾ May not exceed or fall below U_v tolerances.

³⁾ Without load.

⁴⁾ Signal transit time with resistive load.

⁵⁾ With light/dark ratio 1:1.

⁶⁾ A = V_S connections reverse-polarity protected.

⁷⁾ C = interference suppression.

⁸⁾ D = outputs overcurrent and short-circuit protected.

Mechanical data

| | |
|-------------------------------|---------------------------|
| Housing | Rectangular |
| Dimensions (W x H x D) | 15.6 mm x 48.5 mm x 42 mm |
| Connection | Male connector M12, 4-pin |
| Material | |
| Housing | Metal |
| Front screen | Plastic, PMMA |
| Weight | 120 g |

Ambient data

| | |
|--------------------------------------|------------------------------|
| Enclosure rating | IP66 IP67 IP69K |
| Ambient operating temperature | -40 °C ... +60 °C |
| Ambient temperature, storage | -40 °C ... +75 °C |
| UL File No. | NRKH.E181493 & NRKH7.E181493 |

Classifications

| | |
|---------------------|----------|
| eCl@ss 5.0 | 27270902 |
| eCl@ss 5.1.4 | 27270902 |
| eCl@ss 6.0 | 27270902 |

| | |
|-----------------------|----------|
| eCl@ss 6.2 | 27270902 |
| eCl@ss 7.0 | 27270902 |
| eCl@ss 8.0 | 27270902 |
| eCl@ss 8.1 | 27270902 |
| eCl@ss 9.0 | 27270902 |
| eCl@ss 10.0 | 27270902 |
| eCl@ss 11.0 | 27270902 |
| eCl@ss 12.0 | 27270902 |
| ETIM 5.0 | EC002717 |
| ETIM 6.0 | EC002717 |
| ETIM 7.0 | EC002717 |
| ETIM 8.0 | EC002717 |
| UNSPSC 16.0901 | 39121528 |

Adjustments

WL12-3, WSE12-3

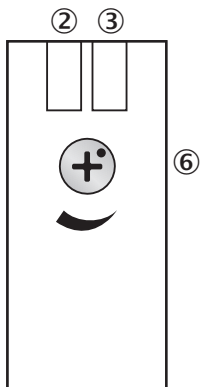

- ② LED indicator yellow: Status of received light beam
- ③ LED indicator green: Supply voltage active
- ⑥ Sensitivity control: potentiometer

Connection type

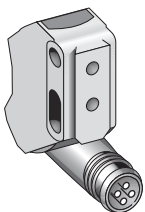

Connection diagram

Cd-083

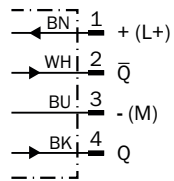

Characteristic curve

WL12-3

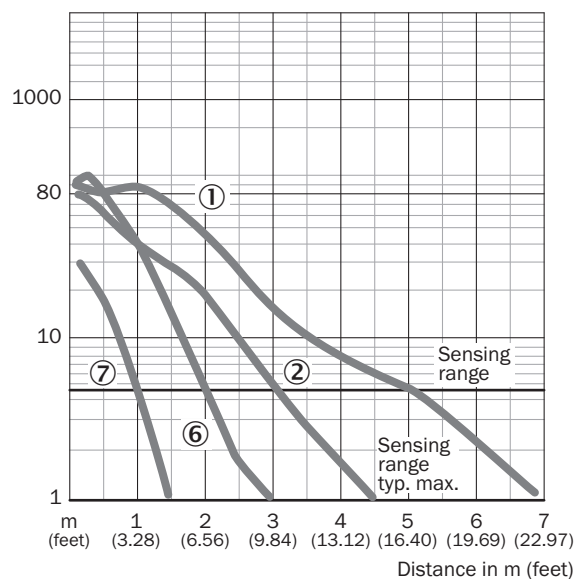

- ① Reflector PL80A
- ② Reflector C110A
- ⑥ Reflector PL20A
- ⑦ Reflective tape

Sensing range diagram

WL12-3

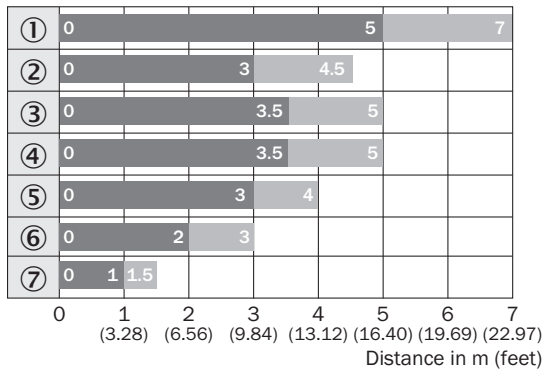

■ Sensing range ■ Sensing range typ. max.

- ① Reflector PL80A
- ② Reflector C110A
- ③ Reflector PL50A
- ④ Reflector PL40A
- ⑤ Reflector PL30A
- ⑥ Reflector PL20A
- ⑦ Reflective tape Diamond Grade

Dimensional drawing (Dimensions in mm (inch))



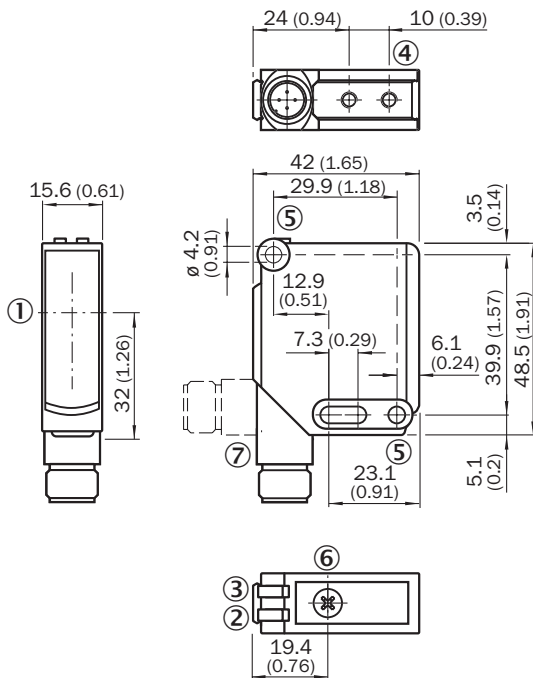

WL12-3, WSE12-3



- ① Optical axis
- ② LED indicator yellow: Status of received light beam
- ③ LED indicator green: Supply voltage active
- ④ M4 threaded mounting hole, 4 mm deep
- ⑤ Mounting hole, $\varnothing 4.2$ mm
- ⑥ Sensitivity control: potentiometer
- ⑦ Connection

Recommended accessories

Other models and accessories → www.sick.com/W12-3

| | Brief description | Type | Part no. |
|---|---|--------------------|----------|
| Mounting brackets and plates | | | |
|  | Universal mounting bracket for reflectors, steel, zinc coated | BEF-WN-REFX | 2064574 |
| Plug connectors and cables | | | |
|  | Head A: female connector, M12, 4-pin, straight, A-coded Head B: Flying leads Cable: Sensor/actuator cable, PVC, unshielded, 5 m | YF2A14-050VB3XLEAX | 2096235 |
|  | Head A: male connector, M12, 4-pin, straight Cable: unshielded | STE-1204-G | 6009932 |
| Reflectors | | | |
|  | Rectangular, screw connection, 18 mm x 60 mm, PMMA/ABS, Screw-on, 2 hole mounting | PL20A | 1012719 |

SICK AT A GLANCE

SICK is one of the leading manufacturers of intelligent sensors and sensor solutions for industrial applications. A unique range of products and services creates the perfect basis for controlling processes securely and efficiently, protecting individuals from accidents and preventing damage to the environment.

We have extensive experience in a wide range of industries and understand their processes and requirements. With intelligent sensors, we can deliver exactly what our customers need. In application centers in Europe, Asia and North America, system solutions are tested and optimized in accordance with customer specifications. All this makes us a reliable supplier and development partner.

Comprehensive services complete our offering: SICK LifeTime Services provide support throughout the machine life cycle and ensure safety and productivity.

For us, that is “Sensor Intelligence.”

WORLDWIDE PRESENCE:

Contacts and other locations –www.sick.com