



# WTB9-3P2261

W9

SMALL PHOTOELECTRIC SENSORS

**SICK**  
Sensor Intelligence.



Illustration may differ



### Ordering information

Type	Part no.
WTB9-3P2261	1049047

Other models and accessories → [www.sick.com/W9](http://www.sick.com/W9)

### Detailed technical data

#### Features

<b>Functional principle</b>	Photoelectric proximity sensor
<b>Functional principle detail</b>	Background suppression
<b>Dimensions (W x H x D)</b>	12.2 mm x 49.8 mm x 23.6 mm
<b>Housing design (light emission)</b>	Rectangular
<b>Mounting hole</b>	M3
<b>Sensing range max.</b>	20 mm ... 350 mm <sup>1)</sup>
<b>Sensing range</b>	20 mm ... 200 mm <sup>2)</sup>
<b>Type of light</b>	Visible red light
<b>Light source</b>	PinPoint LED <sup>3)</sup>
<b>Light spot size (distance)</b>	Ø 4.5 mm (75 mm)
<b>Wave length</b>	650 nm
<b>Adjustment</b>	Potentiometer, 5 turns

<sup>1)</sup> Object with 90% remission (based on standard white, DIN 5033).

<sup>2)</sup> Object with 6% remission (based on standard white, DIN 5033).

<sup>3)</sup> Average service life: 100,000 h at T<sub>J</sub> = +25 °C.

## Mechanics/electronics

<b>Supply voltage</b>	10 V DC ... 30 V DC <sup>1)</sup>
<b>Ripple</b>	< 5 V <sub>pp</sub> <sup>2)</sup>
<b>Current consumption</b>	30 mA <sup>3)</sup>
<b>Switching output</b>	PNP <sup>4)</sup>
<b>Output function</b>	Complementary
<b>Switching mode</b>	Light/dark switching <sup>4)</sup>
<b>Output current I<sub>max.</sub></b>	≤ 100 mA <sup>5)</sup>
<b>Response time</b>	< 0.333 ms <sup>6)</sup>
<b>Switching frequency</b>	1,500 Hz <sup>7)</sup>
<b>Connection type</b>	Male connector M8, 4-pin
<b>Circuit protection</b>	A <sup>8)</sup> B <sup>9)</sup> C <sup>10)</sup>
<b>Protection class</b>	III
<b>Weight</b>	13 g
<b>Housing material</b>	Plastic, VISTAL®
<b>Optics material</b>	Plastic, PMMA
<b>Enclosure rating</b>	IP66 IP67 IP69K
<b>Ambient operating temperature</b>	-40 °C ... +60 °C
<b>Ambient temperature, storage</b>	-40 °C ... +75 °C
<b>UL File No.</b>	NRKH.E181493

<sup>1)</sup> Limit values when operated in short-circuit protected network: max. 8 A.

<sup>2)</sup> May not exceed or fall below U<sub>v</sub> tolerances.

<sup>3)</sup> Without load.

<sup>4)</sup> Q = light switching.

<sup>5)</sup> At and above T<sub>u</sub> 50 °C, a max. load current of I<sub>max.</sub> = 50 mA is permitted.

<sup>6)</sup> Signal transit time with resistive load.

<sup>7)</sup> With light/dark ratio 1:1.

<sup>8)</sup> A = V<sub>S</sub> connections reverse-polarity protected.

<sup>9)</sup> B = inputs and output reverse-polarity protected.

<sup>10)</sup> C = interference suppression.

## Safety-related parameters

<b>MTTF<sub>D</sub></b>	1,030 years
<b>DC<sub>avg</sub></b>	0 %
<b>T<sub>M</sub> (mission time)</b>	20 years

## Classifications

<b>eCl@ss 5.0</b>	27270904
<b>eCl@ss 5.1.4</b>	27270904
<b>eCl@ss 6.0</b>	27270904
<b>eCl@ss 6.2</b>	27270904

<b>eCl@ss 7.0</b>	27270904
<b>eCl@ss 8.0</b>	27270904
<b>eCl@ss 8.1</b>	27270904
<b>eCl@ss 9.0</b>	27270904
<b>eCl@ss 10.0</b>	27270904
<b>eCl@ss 11.0</b>	27270904
<b>eCl@ss 12.0</b>	27270903
<b>ETIM 5.0</b>	EC002719
<b>ETIM 6.0</b>	EC002719
<b>ETIM 7.0</b>	EC002719
<b>ETIM 8.0</b>	EC002719
<b>UNSPSC 16.0901</b>	39121528

### Connection type

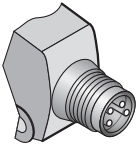

### Connection diagram

Cd-084

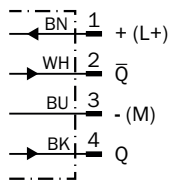

### Characteristic curve

WT9-3, red light, 350 mm

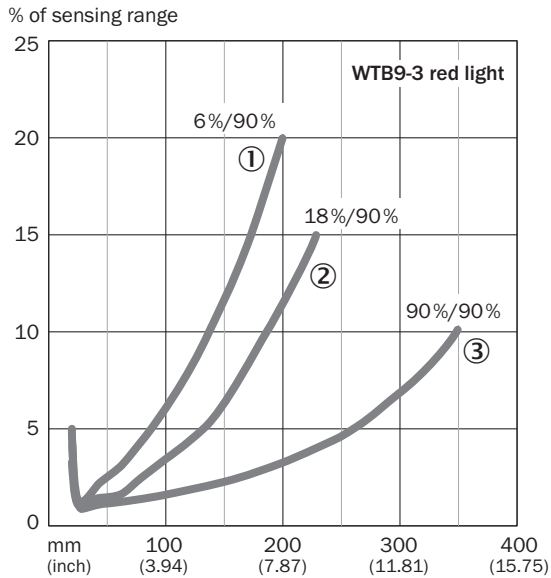

- ① Sensing range on black, 6% remission
- ② Sensing range on gray, 18% remission
- ③ Sensing range on white, 90% remission

### Light spot size

WT9-3, red light, 350 mm

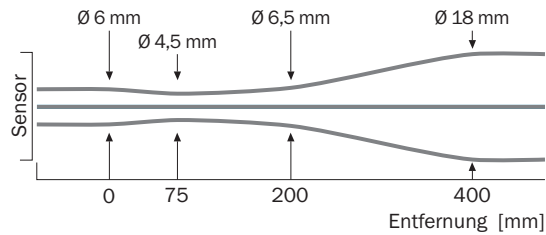

### Sensing range diagram

WT9-3, red light, 350 mm

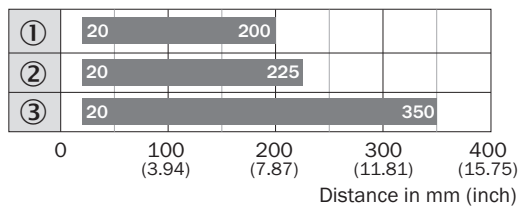

- Sensing range
- ① Sensing range on black, 6% remission
- ② Sensing range on gray, 18% remission
- ③ Sensing range on white, 90% remission

### Adjustments

Potentiometer



- ④ LED indicator yellow: Status of received light beam
- ⑤ LED indicator green: power on
- ⑨ Adjustment of sensing range

### Dimensional drawing (Dimensions in mm (inch))

WT9-3

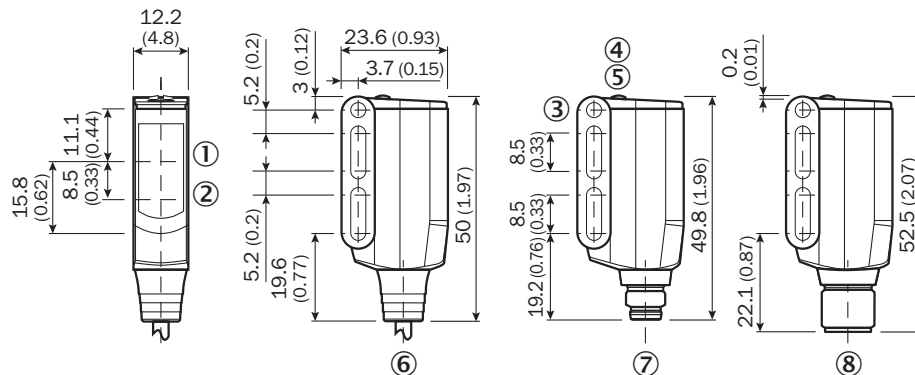

- ① Center of optical axis, receiver
- ② Center of optical axis, sender
- ③ Mounting hole M3 (Ø 3.1 mm)
- ④ LED indicator yellow: Status of received light beam
- ⑤ LED indicator green: power on
- ⑥ Connection cable 2 m
- ⑦ Male connector M8, 4-pin
- ⑧ Male connector M12, 4-pin

### Recommended accessories

Other models and accessories → [www.sick.com/W9](http://www.sick.com/W9)

	Brief description	Type	Part no.
Mounting brackets and plates			
	Mounting bracket, steel, zinc coated, mounting hardware included	BEF-WN-W9-2	2022855

## SICK AT A GLANCE

SICK is one of the leading manufacturers of intelligent sensors and sensor solutions for industrial applications. A unique range of products and services creates the perfect basis for controlling processes securely and efficiently, protecting individuals from accidents and preventing damage to the environment.

We have extensive experience in a wide range of industries and understand their processes and requirements. With intelligent sensors, we can deliver exactly what our customers need. In application centers in Europe, Asia and North America, system solutions are tested and optimized in accordance with customer specifications. All this makes us a reliable supplier and development partner.

Comprehensive services complete our offering: SICK LifeTime Services provide support throughout the machine life cycle and ensure safety and productivity.

For us, that is “Sensor Intelligence.”

## WORLDWIDE PRESENCE:

Contacts and other locations –[www.sick.com](http://www.sick.com)