



▶ PNOZ m C0

PILZ
THE SPIRIT OF SAFETY

Operating Manual-1006013-EN-03

- Configurable, safe small controllers PNOZmulti 2



This document is the original document.

Where unavoidable, for reasons of readability, the masculine form has been selected when formulating this document. We do assure you that all persons are regarded without discrimination and on an equal basis.

All rights to this documentation are reserved by Pilz GmbH & Co. KG. Copies may be made for the user's internal purposes. Suggestions and comments for improving this documentation will be gratefully received.

Pilz®, PIT®, PMI®, PNOZ®, Primo®, PSEN®, PSS®, PVIS®, SafetyBUS p®, SafetyEYE®, SafetyNET p®, the spirit of safety® are registered and protected trademarks of Pilz GmbH & Co. KG in some countries.



SD means Secure Digital

1	Introduction	5
1.1	Validity of documentation	5
1.2	Using the documentation	5
1.3	Definition of symbols	5
1.4	Third-party manufacturer licence information	6
2	Overview	7
2.1	Range	7
2.2	Unit features	7
2.3	Chip card	8
2.4	Front view	8
3	Safety	10
3.1	Intended use	10
3.2	Applicable documentation	11
3.3	System requirements	11
3.4	Safety regulations	11
3.4.1	Safety assessment	11
3.4.2	Use of qualified personnel	11
3.4.3	Warranty and liability	12
3.4.4	Disposal	12
3.4.5	For your safety	12
4	Security	13
4.1	Implemented security measures	13
4.2	Required security measures	13
5	Function description	14
5.1	Integrated protection mechanisms	14
5.2	Functions	14
5.3	Reaction times	14
5.4	Block diagram	15
5.5	Diagnostics	15
5.6	Device security	15
5.6.1	User management	15
5.6.2	Security device key	16
6	Installation	18
6.1	Control cabinet installation	18
6.1.1	Mounting distances	19
6.2	Dimensions in mm	20
7	Commissioning	21
7.1	General wiring guidelines	21
7.2	Connection	21
7.3	Load project from chip card	23
7.4	Load project via USB port	23
7.5	Function test during commissioning	23

7.6	Using the chip card	24
7.7	Connection example	25
8	Operation	26
9	Factory reset	27
10	Maintenance and testing	28
11	Technical details	29
11.1	Safety characteristic data	32
11.2	Classification according to ZVEI, CB24I	33
12	Supplementary data	34
12.1	Maximum capacitive load C (μF) with load current I (A) at the semiconductor outputs	34
12.2	Permitted ambient temperature T_{amb} dependent on the total current I_{sum}	34
13	Order reference	35
13.1	Product	35
13.2	Accessories	35
13.2.1	Replacement terminals	35
13.2.2	Cable	35
14	EC declaration of conformity	36
15	UKCA-Declaration of Conformity	37

1 Introduction

1.1 Validity of documentation

This documentation is valid for the product PNOZ m C0 from Version HW:01, FW:01.01.

This operating manual explains the function and operation, describes the installation and provides guidelines on how to connect the product.

1.2 Using the documentation

This document is intended for instruction. Only install and commission the product if you have read and understood this document. The document should be retained for future reference.

1.3 Definition of symbols

Information that is particularly important is identified as follows:



DANGER!

This warning must be heeded! It warns of a hazardous situation that poses an immediate threat of serious injury and death and indicates preventive measures that can be taken.



WARNING!

This warning must be heeded! It warns of a hazardous situation that could lead to serious injury and death and indicates preventive measures that can be taken.



CAUTION!

This refers to a hazard that can lead to a less serious or minor injury plus material damage, and also provides information on preventive measures that can be taken.



NOTICE

This describes a situation in which the product or devices could be damaged and also provides information on preventive measures that can be taken. It also highlights areas within the text that are of particular importance.



INFORMATION

This gives advice on applications and provides information on special features.

1.4 **Third-party manufacturer licence information**

This product includes Open Source software with various licenses.

Further information is available in the document "Third-party manufacturer licence information PNOZ m C0" (document number 1006087) at www.pilz.com.

2 Overview

2.1 Range

- ▶ Base unit PNOZ m C0

2.2 Unit features

Application of the product PNOZ m C0:

Standalone base unit of the configurable control system PNOZmulti 2

The product has the following features:

- ▶ Can be configured in the PNOZmulti Configurator
- ▶ Semiconductor outputs:
 - 4 safety outputs
depending on the application, up to PL e of EN ISO 13849-1 and up to SIL 3 of EN IEC 62061
- ▶ 8 safe inputs for connecting, for example:
 - Emergency stop pushbuttons
 - Two-hand pushbuttons
 - Safety gate limit switches
 - Start buttons
 - Light barriers
 - Scanner
 - Enabling switches
 - PSEN
 - Operating mode selector switches

Alternatively, inputs IM0 and IM1 can be configured as signal outputs.

The pulse suppression time for the inputs can be changed in the PNOZmulti Configurator.

A change of the preset pulse suppression time (see [Technical details \[📖 29\]](#)) can be used to suppress the self-monitored outputs and for interference suppression.

- ▶ 2 configurable outputs
 - Can be configured as:
 - Test pulse outputs
 - or
 - Signal outputs

- ▶ LED display for:
 - Supply voltage
 - Run operating state
 - Diagnostics
 - Internal and external fault
 - Fault at the outputs
 - Fault at the inputs
- ▶ Test pulse outputs used to monitor shorts across the inputs
- ▶ Monitoring of shorts between the safety outputs
- ▶ Plug-in connection terminals:
 - Either spring-loaded terminal or screw terminal available as accessories (see Order references)

2.3 Chip card

As an option, a chip card can be used to transfer project data.

Chip cards with 8 kByte and 32 kByte memories are available. For large-scale projects we recommend the 32 kByte chip card (see Technical Catalogue: Accessories).

2.4 Front view

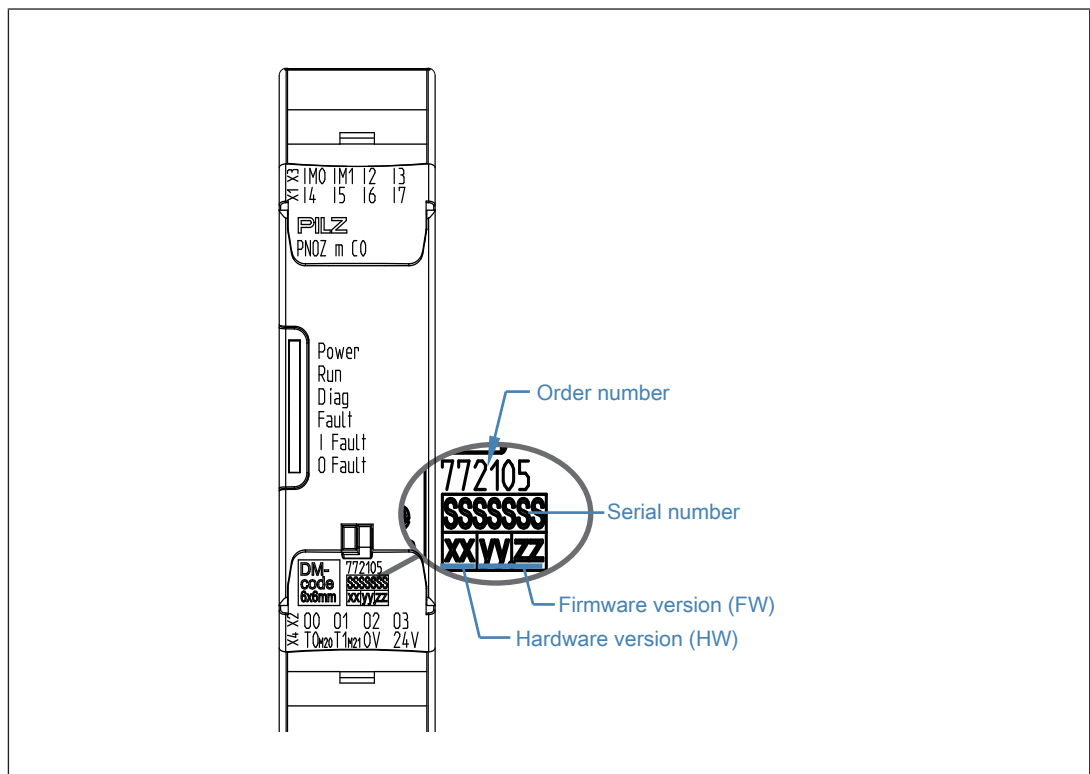

Legend

- X1: Inputs I4 ... I7
- X2: Semiconductor outputs O0 ... O3

- X3: Configurable inputs/outputs IM0 and IM1
Inputs I2 ... I3
- X4: Configurable test pulse/auxiliary outputs T0M20 and T1M21
Supply connections 24 V and 0 V
- LEDs: Power
Run
Diag
Fault
I Fault
O Fault

3 Safety

3.1 Intended use

The standalone base unit PNOZ m C0 is used for the safety-related interruption of safety circuits and is designed for use in:

- ▶ Emergency stop equipment
- ▶ Safety circuits in accordance with VDE 0113 Part 1 and EN 60204-1



CAUTION!

Inputs and outputs for standard functions must not be used for safety-related applications.

Lifts Directive

The product PNOZ m C0 can be used as a PESSRAL (programmable electronic system in safety-related applications for lifts) in accordance with the Lifts Directive 2014/33/EU. It meets the requirements for passenger and goods lifts in accordance with EN 81-1/2, EN 81-20, EN 81-22 and EN 81-50, as well as the requirements for escalators and moving walks in accordance with EN 115-1.

The safety controller should be installed in a protected environment that meets at least the requirements of pollution degree 2.

Example: Protected inside space or control cabinet with protection type IP54 and appropriate air conditioning.

Year of manufacture

The year of manufacture is specified on the product after the reference YOM (Year of Manufacturing).

Improper use

The following is deemed improper use in particular:

- ▶ Any component, technical or electrical modification to the product,
- ▶ Use of the product outside the areas described in this operating manual,
- ▶ Use of the product outside the technical details (see chapter entitled [Technical Details](#) [📖 29]).



NOTICE

EMC-compliant electrical installation

The product is designed for use in an industrial environment. The product may cause interference if installed in other environments. If installed in other environments, measures should be taken to comply with the applicable standards and directives for the respective installation site with regard to interference.

3.2 Applicable documentation

This document includes only part of the information required for the use of the device. To understand and correctly use the product you must read further documents.

Please read the following documents:

- ▶ "PNOZmulti Safety Manual"
- ▶ "PNOZmulti Installation Manual"
- ▶ The advanced functions of the device are described in the online help for the PNOZmulti Configurator and in the document "PNOZmulti Special Applications". Only use these functions once you have read and understood the documentation.

3.3 System requirements

Please refer to the "Product Modifications" document in the "Version overview" section for details of which versions of the PNOZmulti Configurator can be used for this product.

3.4 Safety regulations

3.4.1 Safety assessment

Before using a device, a safety assessment in accordance with the Machinery Directive is required.

The product as an individual component fulfils the functional safety requirements in accordance with EN ISO 13849 and EN IEC 62061. However, this does not guarantee the functional safety of the overall plant/machine. To achieve the relevant safety level of the overall plant/machine's required safety functions, each safety function needs to be considered separately.

3.4.2 Use of qualified personnel

The products may only be assembled, installed, programmed, commissioned, operated, maintained and decommissioned by persons who are competent to do so.

A competent person is a qualified and knowledgeable person who, because of their training, experience and current professional activity, has the specialist knowledge required. In order to inspect, assess and handle products, devices, systems, plant and machinery, this person must be familiar with the state of the art and the applicable national, European and international laws, directives and standards.

It is the company's responsibility only to employ personnel who

- ▶ Are familiar with the basic regulations concerning health and safety / accident prevention,
- ▶ Have read and understood the information provided in the section entitled Safety
- ▶ Have a good knowledge of the generic and specialist standards applicable to the specific application.

3.4.3 **Warranty and liability**

All claims to warranty and liability will be rendered invalid if

- ▶ The product was used contrary to the purpose for which it is intended,
- ▶ Damage can be attributed to not having followed the guidelines in the manual,
- ▶ Operating personnel are not suitably qualified,
- ▶ Any type of modification has been made (e.g. exchanging components on the PCB boards, soldering work etc.).

3.4.4 **Disposal**

- ▶ In safety-related applications, please comply with the mission time T_M in the safety-related characteristic data.
- ▶ When decommissioning, please comply with local regulations regarding the disposal of electronic devices (e.g. Electrical and Electronic Equipment Act).

3.4.5 **For your safety**

The unit meets all the necessary conditions for safe operation. However, you should always ensure that the following safety requirements are met:

- ▶ This operating manual only describes the device's basic functions. The advanced functions are described in the online help for the PNOZmulti Configurator and in the document "PNOZmulti Special Applications". Only use these functions once you have read and understood the documentation.
- ▶ Please note the "PNOZmulti Installation Manual".
- ▶ You must note the information stated in the "PNOZmulti Safety Manual".
- ▶ Adequate protection circuit must be provided for all inductive consumers.
- ▶ Do not open the housing or make any unauthorised modifications.
- ▶ Please make sure you shut down the supply voltage when performing maintenance work (e.g. exchanging contactors).

4 Security

To secure plants, systems, machines and networks against cyberthreats it is necessary to implement (and continuously maintain) an overall industrial security concept that is state of the art.

Perform a risk assessment in accordance with VDI/VDE 2182 or IEC 62443-3-2 and plan the security measures with care. If necessary, seek advice from Pilz Customer Support.

4.1 Implemented security measures

- ▶ To carry out relevant operations in the PNOZmulti Configurator, a user must authenticate himself on the device with user name and password.
- ▶ Multiple users with different permissions can be created and configured in the PNOZmulti Configurator.
The user data is transmitted to the device and stored there.
- ▶ In the base unit PNOZ m C0 a security device key can be stored.
The security device key includes the following functions:
 - Verifiable trust anchor in the device for the plant manufacturer.
In the PNOZmulti Configurator you can verify whether a device key from device key management matches the device key on the connected device.
 - Ensure the authenticity of project data on the chip card
The base unit PNOZ m C0 accepts project data on the chip card only if it has been generated using the identical security device key.

4.2 Required security measures

- ▶ The product is not protected from physical manipulation or from reading of memory contents during physical access. Use appropriate measures to ensure that there is no physical access by unauthorised persons. You should also use security seals so that you can detect any manipulation of the product or interfaces. Installation inside a lockable control cabinet is recommended as a minimum measure.
- ▶ Protect the configuration and log data from unauthorised changes.
- ▶ Check the product's log for unauthorised program changes on a regular basis.
- ▶ A factory-set default password is active on the base unit along with permissions for users who are not logged in. Change the password immediately after logging in for the first time.
- ▶ Assign different permissions for the various user groups (e.g. diagnostics - configuration).
- ▶ The project data on the chip card is not protected when the security device key is not used, and it can be read by unauthorised persons.
 - Use the security device key to protect the project data during transfer
or
 - Remove the chip card.
- ▶ Only assign strong passwords and handle the passwords carefully. Be guided by generally accepted guidelines such as NIST 800-63b for example.

5 Function description

5.1 Integrated protection mechanisms

The relay meets the following safety requirements:

- ▶ The circuit is redundant with built-in self-monitoring.
- ▶ The safety device remains effective in the case of a component failure.
- ▶ The safety outputs are tested periodically using a disconnection test.

5.2 Functions

The function of the inputs and outputs on the control system depends on the user program created using the PNOZmulti Configurator. The user program is transferred to the base unit via chip card or via the USB port. The base unit has 2 microcontrollers that monitor each other. They evaluate the base unit's input circuits and switch the outputs accordingly.

The LEDs on the base unit indicate the status of the configurable control system PNOZmulti.

The online help for the PNOZmulti Configurator contains descriptions of the operating modes and all the functions of the control system, plus connection examples.

5.3 Reaction times

$t_{\text{ReactionMax}} = t_{\text{Max input delay}} + t_{\text{Max processing time}} + t_{\text{Max switch-off delay at the output}}$

Please note that the reaction time is also increased by

- ▶ Delay times configured in the user program
- ▶ Delay on the sensor that is used
- ▶ Delay on the actuator that is used

Example configuration: PNOZ m C0

Input PNOZ m C0 Max. input delay	Processing in the user program Processing time	Output PNOZ m C0 Switch-off delay
14ms	5 ms	1 ms

$$t_{\text{ReactionMax}} = 14 \text{ ms} + 5 \text{ ms} + 1 \text{ ms}$$

$$t_{\text{ReactionMax}} = 20 \text{ ms}$$

5.4 Block diagram

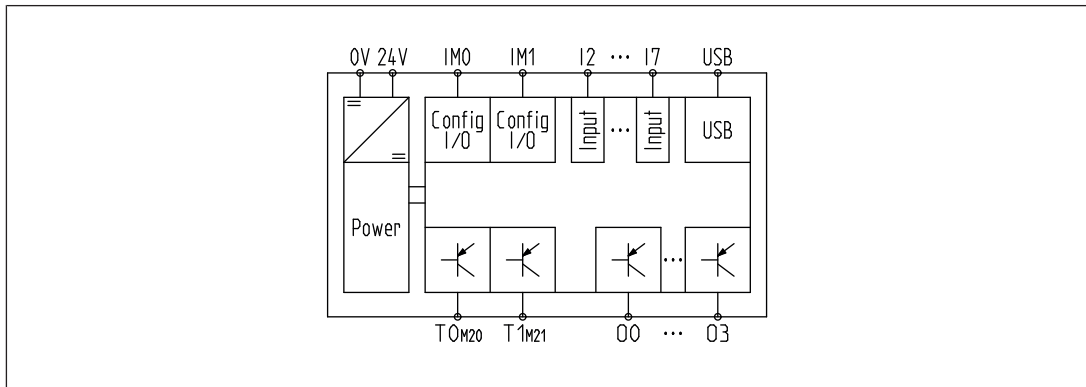

5.5 Diagnostics

The status and error messages displayed by the LEDs are saved in an error stack. This error stack can be read out from PNOZmulti Configurator via the USB interface.

5.6 Device security

5.6.1 User management

The base unit PNOZ m C0 can be protected from unauthorised access via user management.

In order to access the device or perform specific actions via the PNOZmulti Configurator, a user must use his credentials to authenticate himself.

A user account can be created for each user in the PNOZmulti Configurator's user management.

There are user groups that have access permissions with pre-defined permissions.

A user group is assigned to each user account.

Each user account obtains a unique user name and a password.

When you log into a new device for the first time or after a factory reset has been performed, use the factory-set default credentials to log in as administrator:

Login name	admin
Password	pilz

As administrator you have all the available permissions. Change the default password immediately after logging in for the first time.

User management is configured in the PNOZmulti Configurator and transferred to the device.

Detailed information on user management and how it is configured can be found in the online help for the PNOZmulti Configurator.

5.6.2 Security device key

In the base unit PNOZ m C0 a security device key can be stored.



NOTICE

Please note:

When replacing this device in future, a new matching security device key must be present on the new device

The security device key includes the following functions:

- ▶ Verifiable trust anchor in the device for the plant manufacturer. In the PNOZmulti Configurator you can verify whether a device key from device key management matches the device key on the connected device.
- ▶ Ensure authenticity of project data on the chip card
The PNOZ m C0 accepts project data on the chip card only if it has been generated using the identical security device key. This happens automatically when project data is transferred via the PNOZmulti Configurator or by selecting the correct security device key when the project data is saved directly to the chip card using the PNOZmulti Configurator. The project data is saved on the chip card in encrypted form.
The security device key is generated, edited, written and verified in the PNOZmulti Configurator in security device key management.



CAUTION!

Please note:

An encrypted project can only be decoded using the matching security device key. When the security device key is lost, the device can no longer be decoded.



CAUTION!

When using a chip card, please note:

After the security device key has been changed, the project data on the chip card is no longer trustworthy.

- Load the project data on to the device again via the PNOZmulti Configurator
or
- Remove the chip card

A factory reset resets the security device key.

Users who are signed in as administrators can overwrite the security device key. In this case, a prior factory reset is not required.



NOTICE

Please note

To write a device key to a device, the device must be in stop state.

6 Installation

6.1 Control cabinet installation

- ▶ The unit should be installed in a control cabinet with a protection type of at least IP54.
- ▶ Install the system vertically on to a horizontal mounting rail. The venting slots must face upward and downward. Other mounting positions could damage the safety system.
- ▶ Use the locking elements on the rear of the unit to attach it to a mounting rail.
- ▶ In environments exposed to heavy vibration, the unit should be secured using a fixing element (e.g. retaining bracket or end angle).
- ▶ Open the locking slide before lifting the unit from the mounting rail.
- ▶ To comply with EMC requirements, the mounting rail must have a low impedance connection to the control cabinet housing.



NOTICE

Damage due to electrostatic discharge!

Electrostatic discharge can damage components. Ensure against discharge before touching the product, e.g. by touching an earthed, conductive surface or by wearing an earthed armband.

6.1.1 Mounting distances

With control cabinet installation it is essential to maintain a certain distance from the top and bottom, as well as to other heat-producing devices (see diagram). The values stated for the mounting distances are minimum specifications.

The ambient temperature of the product in the control cabinet must not exceed the figure stated in the technical details, otherwise air conditioning may be required.

Mounting distances:

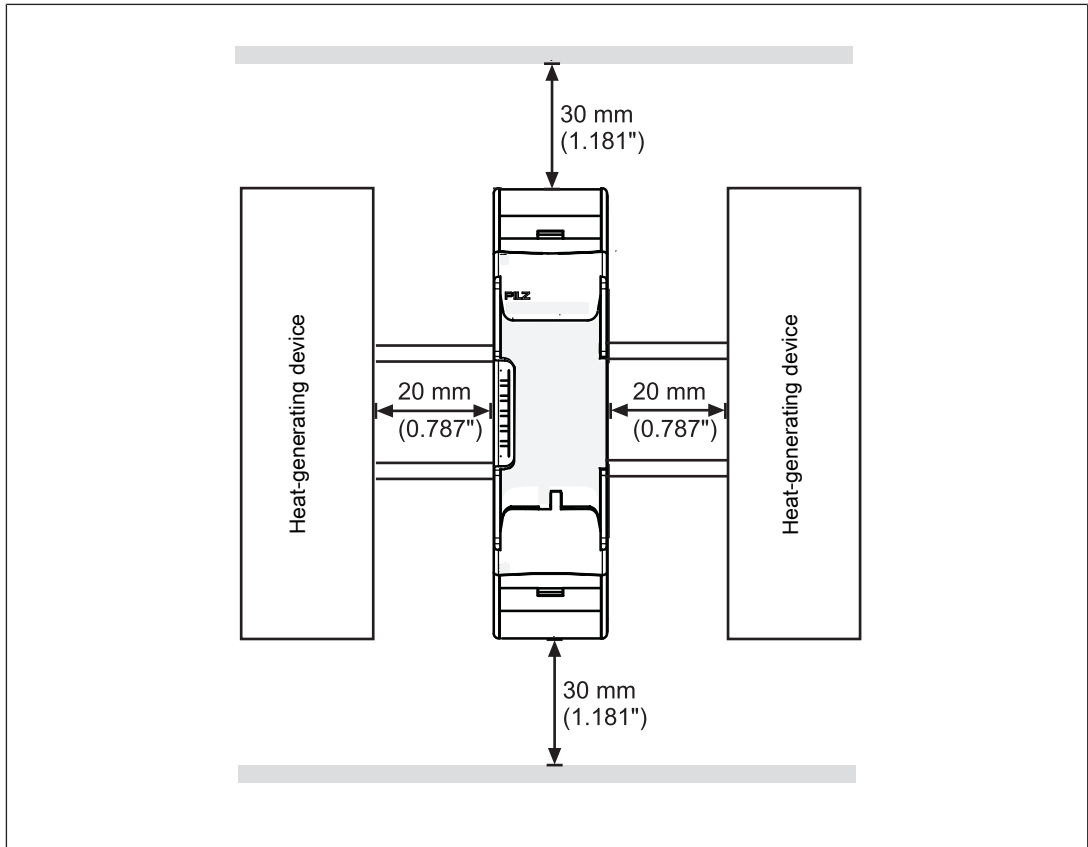

INFORMATION

Please note that at the stated minimum distance, it will be difficult to swap the chip card from above. If you cannot leave a greater distance, remove the unit from the mounting rail to swap the chip card.

6.2 Dimensions in mm

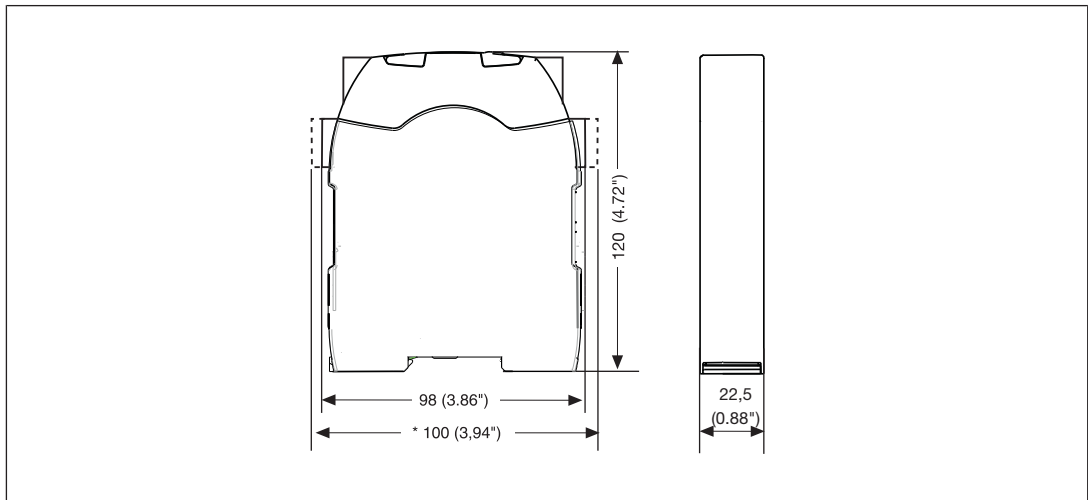

7 Commissioning

7.1 General wiring guidelines

The wiring is defined in the circuit diagram in the Configurator. There you can select the inputs that are to perform a safety function and the outputs that are to switch this safety function.

Note:

- ▶ Information given in the [Technical details \[29\]](#) must be followed.
- ▶ Outputs O0 to O3 are semiconductor outputs
- ▶ Use copper wiring with a temperature stability of 75 °C.
- ▶ Sufficient protection circuit must be provided on all output contacts with inductive loads.
- ▶ The safety system and input circuits must always be supplied by a single power supply. The power supply must meet the regulations for extra low voltages with protective separation (SELV/PELV).
- ▶ Do not route the test pulse cables together with actuator cables within an unprotected sheathed cable.

7.2 Connection

Procedure:

- ▶ Wire the inputs and outputs on the base unit in accordance with the circuit diagram.
- ▶ Connect the supply voltage:
 - Terminal 24 V: + 24 V DC
 - 0V terminal: 0 V

Input circuit	Single-channel	Dual-channel
Emergency stop without detection of shorts across contacts		
Emergency stop with detection of shorts across contacts		
Start circuit	Input circuit without detection of shorts across contacts	Input circuit with detection of shorts across contacts

Semiconductor outputs		
Redundant output		
Single output		
Single output with advanced fault detection*		

*Two loads may be connected to each safety output with advanced fault detection, even on applications in accordance with EN IEC 62061, SIL 3. Prerequisite: Feedback loop is connected, shorts across contacts and external power sources are excluded (e.g. through separate multicore cables). Please note that, in the event of an error in the feedback loop, the safety system switches to a safe state and shuts down **all** the outputs.

Feedback loop	Redundant output	
Contacts from external contactors		

7.3 Load project from chip card

If you have a brand new device and a chip card containing a project is inserted, the project on the chip card is transferred to the base unit's internal memory when the device is switched on.

For devices that have already been used, proceed as follows:

- ▶ Insert the chip card containing the current project into the card slot on the base unit.
- ▶ Switch on the supply voltage.
- ▶ Remove the chip card as soon as the chip card has been detected by the base unit and the Run and Diag LEDs flash.
The chip card must be removed no later than 3s after the chip card is detected.
If the chip card has been removed within the required time, the Diag LED lights and the Run LED is off.
- ▶ Insert the chip card back into the card slot within 5 s.
When the chip card has once again been detected, the project is transferred into the base unit's internal memory. The Diag LED flashes
- ▶ Once the project has been transferred successfully, the chip card can be left inserted in the base unit or can be removed.

7.4 Load project via USB port

Procedure:

- ▶ Connect the computer containing the PNOZmulti Configurator to the base unit via the USB port.
- ▶ Switch on the supply voltage.
- ▶ Download the project (see PNOZmulti Configurator's online help).



INFORMATION

If a chip card is inserted in the base unit when the project is loaded via the USB port, then the project data is simultaneously saved on the chip card.

7.5 Function test during commissioning



CAUTION!

It is essential to check that the safety devices operate correctly

- After the project has been loaded from the chip card
- After the project has been loaded from the PNOZmulti Configurator via the USB port

7.6 Using the chip card



NOTICE

The chip card contact is only guaranteed if the contact surface is clean and undamaged. For this reason please protect the chip card's contact surface from

- Contamination
- Contact
- Mechanical impact, such as scratches.

Make sure that you do not bend the chip card as you insert it into the chip card slot.

The chip card is not required in order to operate the device.

To remove the chip card, press on the chip card and then pull it out.

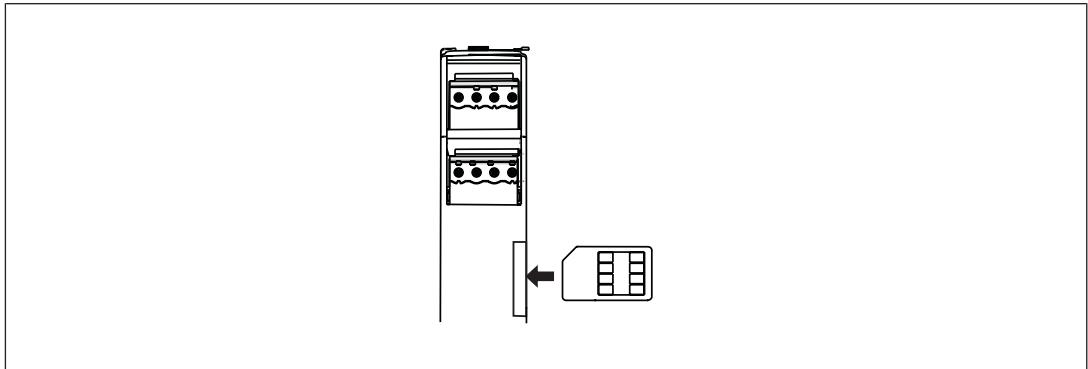

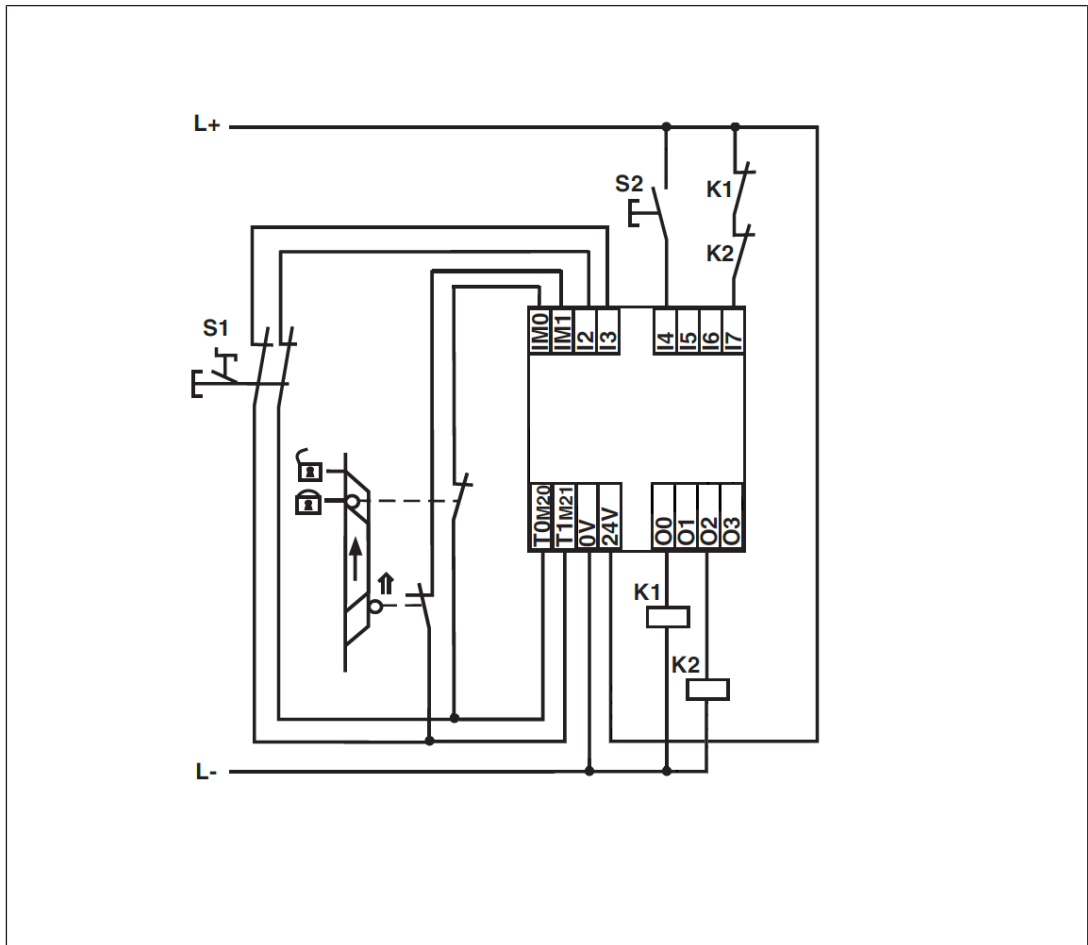

7.7 Connection example













8 Operation

The PNOZmulti control system is ready for operation when the "POWER" and "RUN" LEDs on the base unit are lit continuously.

Legend

-  LED on
-  LED flashes
-  LED off

Basic					Error
Run	Diag	Fault	IFAULT	OFAULT	
●					The device must be restarted because a project was transferred, for example.
●					External fault on the base unit, leading to a safe state, e.g. project configuration error.
●					External fault on the outputs of the base unit, e.g. short across the contacts, leading to a safe state.
●					Internal error on the base unit
●					Internal error on the base unit (inputs)
					Base unit in a STOP state
					External fault on the inputs of the base unit, which does not lead to a safe state, e.g. partially operated
					External error on the outputs of the base unit, which does not lead to a safe state, e.g. feedback input defective or short across contacts on a signal output

9 Factory reset

A factory reset of the device is always sensible or indeed necessary when the device is removed from the existing plant/machine, possibly to re-use it in another application.

During a factory reset, all the data stored in the device is reset:

- ▶ Project data is deleted from the internal memory.
- ▶ If a chip card is inserted, it is deleted and formatted.
- ▶ Error stack is deleted
- ▶ Program change log is deleted
- ▶ Configured user data (user name, passwords, permissions) is deleted and is reset to the default values.

You can initiate a factory reset both in the PNOZmulti Configurator (see online help for the PNOZmulti Configurator) and also directly on the device.

Initiate factory reset directly on the device



CAUTION!

Before performing the factory reset, please note:

Remove terminal block X2 (o0 ... o3) from the device and ensure that the actuator cannot be activated via the short across the contacts that will be created.

Procedure:

- ▶ Switch off the supply voltage to the base unit.
- ▶ Create a short across the contacts at o3 to the 24 V of the supply voltage.
- ▶ Switch on the supply voltage.
- ▶ Carry out each of the following steps within 3 s:
 - Remove the short across the contacts from o3 as soon as the short has been detected by the base unit and the OFault and Diag LEDs flash.
 - When the o0 terminal LED lights, create a short across the contacts at o0 to 24 V and then remove it as soon as the o0 LED goes out.
 - When the o3 terminal LED lights, create a short across the contacts at o3 to 24 V and then remove it as soon as the o3 LED goes out.

The base unit performs a factory reset, which is completed successfully when the Diag LED flashes rapidly.

10 Maintenance and testing

It is not necessary to perform maintenance work on the product in normal operation. Please return any faulty products to Pilz.

11 Technical details

General	
Certifications	CE, TÜV, UKCA, cULus Listed
Application range	Failsafe
Electrical data	
Supply voltage	
for	Module supply
Voltage	24 V
Kind	DC
Voltage tolerance	-20 %/+25 %
Max. continuous current that the external power supply must provide	8,5 A
Output of external power supply (DC)	204 W
Output of external power supply (DC) at no load	1,1 W
External unit fuse protection F1	10 A, circuit breaker 24 VDC, characteristic B / 10 A, 60 VDC, SCCR: 10 kA, [UL 498/CSA C22.2 No. 5, DIVQ/7]
Max. power dissipation of module	4 W
Status indicator	LED
Permitted loads	inductive, capacitive, resistive
Configurable inputs/outputs (inputs or auxiliary outputs)	
Quantity	2
Potential isolation	No
Configurable inputs	
Input voltage in accordance with EN 61131-2 Type 1	24 V
Input current at rated voltage	5 mA
Input current range	2,5 - 5,3 mA
Pulse suppression	0,5 ms
Maximum input delay	14 ms
Configurable auxiliary outputs	
Voltage	24 V
Output current	100 mA
Output current range	0 - 120 mA
Max. transient pulsed current	200 mA
Short circuit-proof	Yes
Residual current at "0"	0,05 mA
Voltage at "1"	UB - 2 V at 0.1 A
Inputs	
Quantity	6
Input voltage in accordance with EN 61131-2 Type 1	24 V DC
Input current at rated voltage	5 mA
Input current range	2,5 - 5,3 mA
Pulse suppression	0,5 ms

Inputs	
Maximum input delay	14 ms
Potential isolation	No
Semiconductor outputs	
Number of positive-switching single-pole semiconductor outputs	4
Switching capability	
Voltage	24 V
Current	2 A
Permitted current range	0,000 - 2,400 A
Residual current at "0" signal	0,05 mA
Max. transient pulsed current	4 A
Max. capacitive load	1 µF
Max. internal voltage drop	500 mV
Max. duration of off time during self test	400 µs
Switch-off delay	1 ms
Potential isolation	No
Short circuit-proof	Yes
Test pulse outputs	
Number of test pulse outputs	2
Voltage	24 V
Current	0,1 A
Max. duration of off time during self test	4 ms
Short circuit-proof	Yes
Potential isolation	No
USB interface	
Connection	Mini-B socket
Max. cable length	3 m
Times	
Simultaneity in the two-hand circuit	0,5 s
Processing time	5 ms
Environmental data	
Ambient temperature	
in accordance with the standard	EN 60068-2-14
Temperature range	0 - 65 °C
Forced convection in control cabinet off	55 °C
Storage temperature	
in accordance with the standard	EN 60068-2-1/-2
Temperature range	-25 - 70 °C
Climatic suitability	
in accordance with the standard	EN 60068-2-30, EN 60068-2-78
Condensation during operation	Not permitted
Max. operating height above SL	2000 m
EMC	EN 61131-2

Environmental data

Vibration	
in accordance with the standard	EN 60068-2-6
Frequency	5 - 150 Hz
Acceleration	1g
Shock stress	
in accordance with the standard	EN 60068-2-27
Acceleration	15g
Duration	11 ms
Airgap creepage	
in accordance with the standard	EN 61131-2
Overvoltage category	II
Pollution degree	2
Protection type	
in accordance with the standard	EN 60529
Housing	IP20
Terminals	IP20
Mounting area (e.g. control cabinet)	IP54

Mechanical data

Mounting position	horizontally on mounting rail
DIN rail	
Top hat rail	35 x 15 EN/IEC 60715, 35 x 7,5 EN/IEC 60715
Recess width	27 mm
Cable length	
Max. cable length per input	1 km
Sum of individual cable lengths at the test pulse output	2 km
Material	
Bottom	PC
Front	PC
Top	PC
Connection type	Spring-loaded terminal, screw terminal
Mounting type	plug-in
Conductor cross section with screw terminals	
1 core flexible	0,25 - 2,5 mm², 24 - 12 AWG
2 core with the same cross section, flexible without crimp connectors or with TWIN crimp connectors	0,2 - 1,5 mm², 24 - 16 AWG
Torque setting with screw terminals	0,5 Nm
Conductor cross section with spring-loaded terminals:	
Flexible with/without crimp connector	0,2 - 2,5 mm², 24 - 12 AWG
Spring-loaded terminals: Terminal points per connection	2
Stripping length with spring-loaded terminals	9 mm
Dimensions	
Height	101,4 mm
Width	22,5 mm
Depth	120 mm

Mechanical data

Weight **105 g**

Where standards are undated, the 2022-02 latest editions shall apply.

11.1 Safety characteristic data



NOTICE

You must comply with the safety characteristic data in order to achieve the required safety level for your plant/machine.

Unit	Operating mode	EN ISO 13849-1: 2015	EN ISO 13849-1: 2015	EN IEC 62061	EN IEC 62061	EN/IEC 61511	EN/IEC 61511	EN ISO 13849-1: 2015
		PL	Category	SIL CL/ maximum SIL	PFH _D [1/h]	SIL	PFD	T _M [year]

Input

Inputs	1-channel	PL d	Cat. 2	SIL 2	7,75E-09	SIL 2	6,80E-04	20
Inputs	2-channel	PL e	Cat. 4	SIL 3	1,65E-10	SIL 3	1,42E-05	20
Inputs	1-ch., pulsed light barrier	PL e	Cat. 4	SIL 3	7,75E-10	SIL 3	6,85E-05	20

Output

SC outputs	1-channel with advanced fault detection	PL e	Cat. 4	SIL 3	4,49E-10	SIL 3	3,84E-05	20
SC outputs	1-channel	PL d	Cat. 2	SIL 2	7,08E-10	SIL 2	6,03E-05	20
SC outputs	2-channel	PL e	Cat. 4	SIL 3	4,66E-10	SIL 3	4,00E-05	20

Explanatory notes for the safety-related characteristic data:

- ▶ Safety characteristic data in accordance with EN IEC 62061 and EN/IEC 61511 was calculated based on EN/IEC 61508.
- ▶ T_M is the maximum mission time in accordance with EN ISO 13849-1. The value also applies as the retest interval in accordance with EN/IEC 61508-6 and EN/IEC 61511 and as the proof test interval and mission time in accordance with EN IEC 62061.

All the units used within a safety function must be considered when calculating the safety characteristic data.



INFORMATION

A safety function's SIL/PL values are **not** identical to the SIL/PL values of the units that are used and may be different. We recommend that you use the PAScal software tool to calculate the safety function's SIL/PL values.

11.2 Classification according to ZVEI, CB24I

The following tables describe the classes and specific values of the product interface and the classes of interfaces compatible with it. The classification is described in the ZVEI position paper "Classification of Binary 24 V Interfaces - Functional Safety aspects covered by dynamic testing".

Input	
Interfaces	
Drain	
Interface	Module
Class	C2
Source	
Interface	Sensor
Class	C2, C3
Drain parameters	
Max. test pulse duration	500 µs
Min. input resistance	3,6 kOhm
Max. capacitive load	65 nF
Single-pole output	
Interfaces	
Source	
Interface	Module
Class	C2
Drain	
Interface	Actuator
Class	C1, C2
Parameter source	
Max. test pulse duration	400 µs
Max. rated current	2 A
Max. capacitive load	1 µF

12 Supplementary data

12.1 Maximum capacitive load C (μF) with load current I (A) at the semiconductor outputs

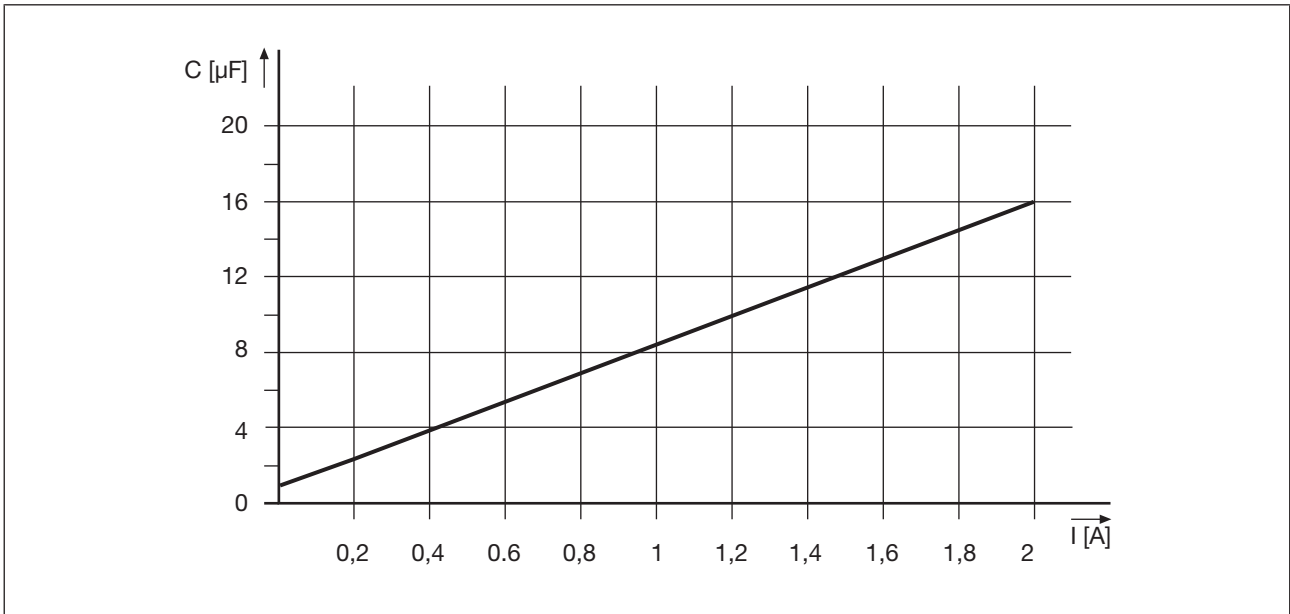

12.2 Permitted ambient temperature T_{amb} dependent on the total current I_{sum}

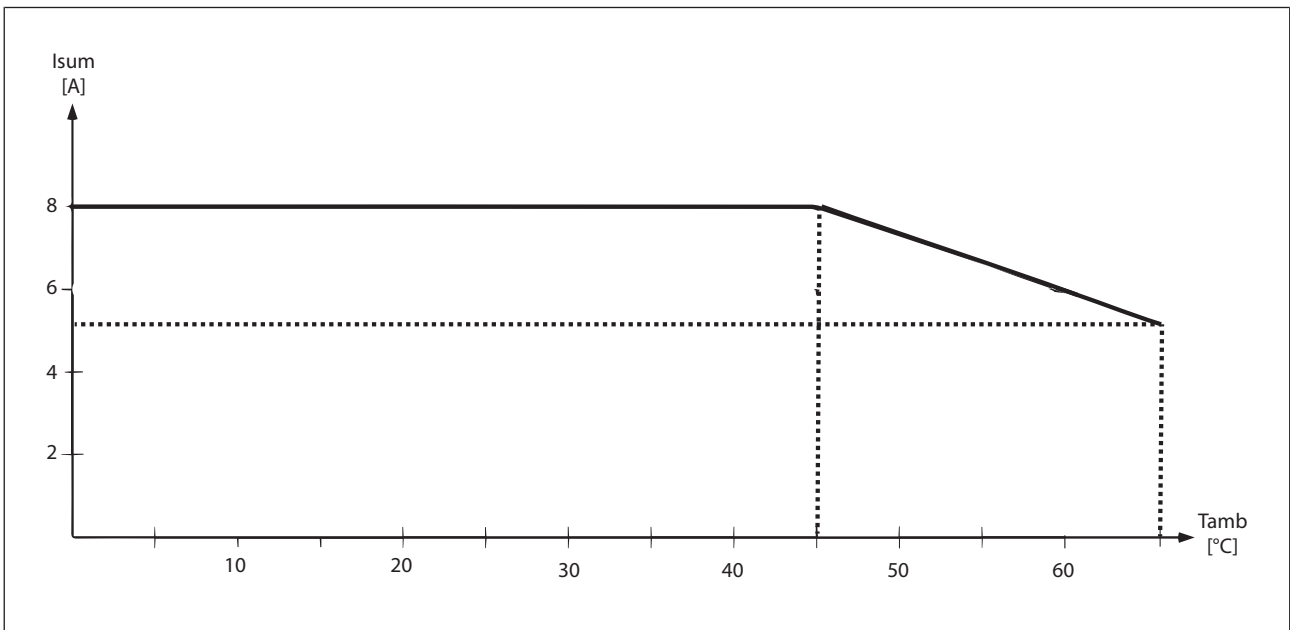

A derating of 133 mA per 1°C must occur from an ambient temperature of 45°C and above.

13 Order reference

13.1 Product

Product type	Features	Order no.
PNOZ m C0	Configurable safe small controllers PNOZmulti 2, standalone base unit, non-expandable, 8 inputs, 4 safe semiconductor outputs.	772105

13.2 Accessories

13.2.1 Replacement terminals

Product type	Features	Order no.
PNOZ s Setscrew terminals 22.5mm	Set of plug-in replacement terminals 4-pin of screw type, PU = 1 piece each X1, X2, X3, X4.	750004
PNOZ s Setspring-loaded terminals 22.5mm	Set of plug-in replacement terminals 4-pin of spring-loaded type, PU = 1 piece each X1, X2, X3, X4.	751004

13.2.2 Cable

Product type	Features	Order no.
PSSu A USB-CAB03	PSSu, USB cable, length 3 m.	312992
Cable/XX/USB-ASM/MIN-BAMX/U/003/Q009/SH	Connection cable, USB 2.0 Type A on USB 2.0 Type Mini-B, conductor cross section: 0.09 mm ² , shielded, cable length: 3 m	772300

14 **EC declaration of conformity**

This product/these products meet the requirements of the directive 2006/42/EC on machinery of the European Parliament and of the Council. The complete EC Declaration of Conformity is available on the Internet at www.pilz.com/downloads.

Representative: Pilz GmbH & Co. KG, Felix-Wankel-Str. 2, 73760 Ostfildern, Germany

15 UKCA-Declaration of Conformity

This product(s) complies with following UK legislation: Supply of Machinery (Safety) Regulation 2008.

The complete UKCA Declaration of Conformity is available on the Internet at www.pilz.com/downloads.

Representative: Pilz Automation Technology, Pilz House, Little Colliers Field, Corby, Northamptonshire, NN18 8TJ United Kingdom, eMail: mail@pilz.co.uk

► Support

Technical support is available from Pilz round the clock.

Americas

Brazil

+55 11 97569-2804

Canada

+1 888 315 7459

Mexico

+52 55 5572 1300

USA (toll-free)

+1 877-PILZUSA (745-9872)

Asia

China

+86 400-088-3566

Japan

+81 45 471-2281

South Korea

+82 31 778 3300

Australia and Oceania

Australia

+61 3 95600621

New Zealand

+64 9 6345350

Europe

Austria

+43 1 7986263-444

Belgium, Luxembourg

+32 9 3217570

France

+33 3 88104003

Germany

+49 711 3409-444

Ireland

+353 21 4804983

Italy, Malta

+39 0362 1826711

Scandinavia

+45 74436332

Spain

+34 938497433

Switzerland

+41 62 88979-32

The Netherlands

+31 347 320477

Turkey

+90 216 5775552

United Kingdom

+44 1536 462203

You can reach our international hotline on:

+49 711 3409-222

support@pilz.com

Pilz develops environmentally-friendly products using ecological materials and energy-saving technologies. Offices and production facilities are ecologically designed, environmentally-aware and energy-saving. So Pilz offers sustainability, plus the security of using energy-efficient products and environmentally-friendly solutions.



We are represented internationally. Please refer to our homepage www.pilz.com for further details or contact our headquarters.

Headquarters: Pilz GmbH & Co. KG, Felix-Wankel-Straße 2, 73760 Ostfildern, Germany
Telephone: +49 711 3409-0, E-Mail: info@pilz.com, Internet: www.pilz.com

PILZ
THE SPIRIT OF SAFETY

CECE[®], CHRE[®], CMSE[®], INDUSTRIAL P[®], Leansafe[®], Myzel[®], PAS4000[®], PASscal[®], PASconfig[®], Pilz[®], PIT[®], PMSprimo[®], PMSprotego[®], PMCiendo[®], PMD[®], PMI[®], PNOZ[®], Primo[®], PSEN[®], PSS[®], PSS[®], PVIS[®], SafetyBUS p[®], SafetyNET p[®], THE SPIRIT OF SAFETY[®] are registered and protected trademarks of Pilz GmbH & Co. KG in some countries. We would point out that product features may vary from the details stated in this document, depending on the status at the time of publication and the scope of the equipment. We accept no responsibility for the validity, accuracy and entirety of the text and graphics presented in this information. Please contact our Technical Support if you have any questions.

1006013-EN-03, 2023-10 Printed in Germany
© Pilz GmbH & Co. KG, 2019