



Surface mount enclosures IP65 (4X) for SM1P SM1Z
Surface mount enclosures IP65 (4X) for SM1P SM1P...

Product designation

Product type designation

Description

Accessories for

Mechanical features

Weight g 345

Operations

Mechanical life cycles 100000

Ambient conditions

Temperature

Operating temperature

min	°C	-25
max	°C	+60

Storage temperature

min	°C	-50
max	°C	+80

IEC degree of protection IP65

UL degree of protection 4X

Dimensions [mm (in)]

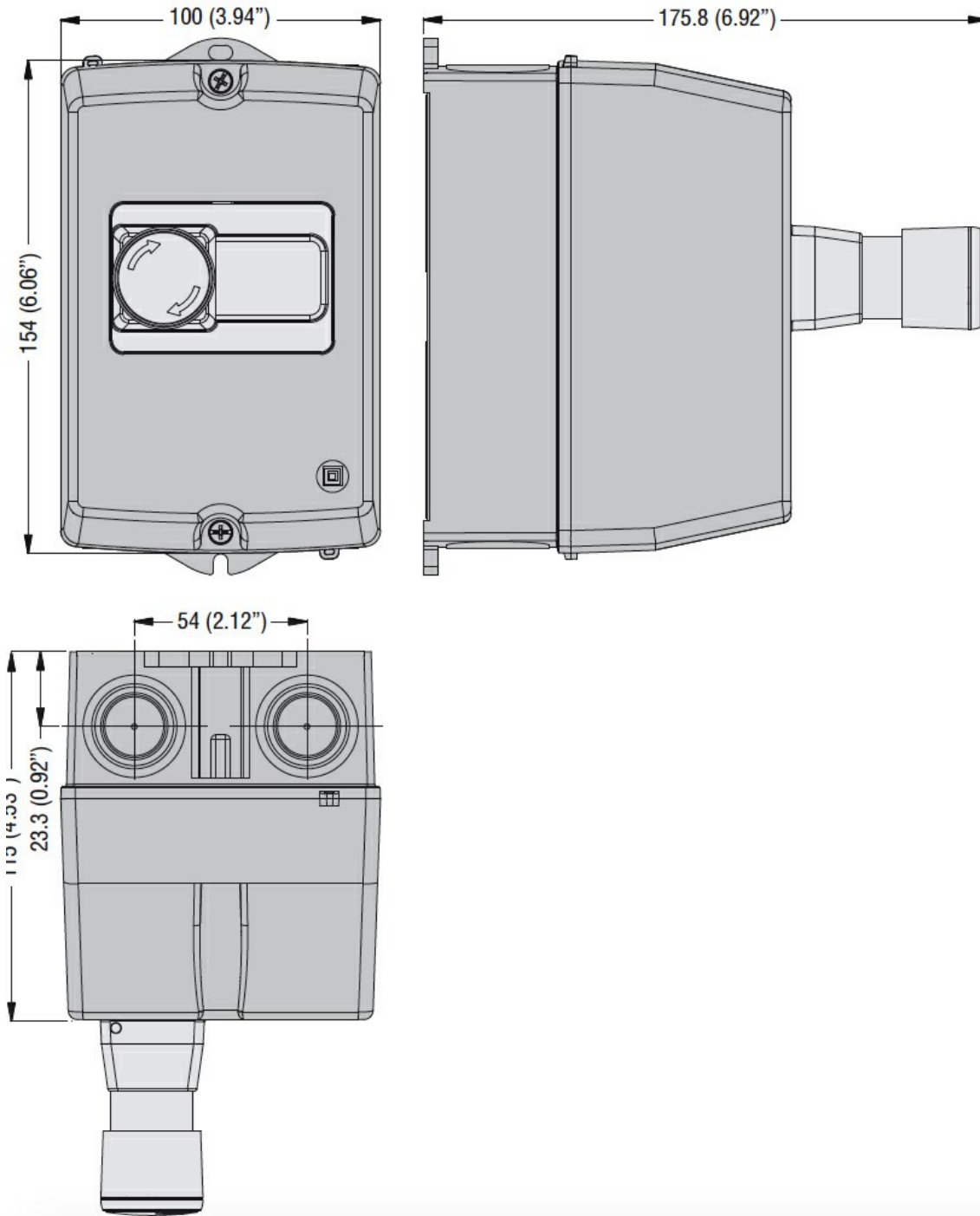

Certifications and compliance

Compliance

CSA C22.2 n° 14

IEC/EN 60947-1

IEC/EN 60947-5-1

UL508

Certificates

cULus

EAC

ETIM classification