



Product designation				Power contactor
Product type designation				BF150
<b>Contact characteristics</b>				
Number of poles	Nr.			3
Rated insulation voltage U <sub>i</sub> IEC/EN	V			1000
Rated impulse withstand voltage U <sub>imp</sub>	kV			8
Operational frequency	min	Hz	25	
	max	Hz	400	
IEC Conventional free air thermal current I <sub>th</sub>	A			165
Operational current I <sub>e</sub>	AC-1 (≤40°C)	A	165	
	AC-1 (≤55°C)	A	135	
	AC-1 (≤70°C)	A	118	
	AC-3 (≤440V ≤55°C)	A	150	
	AC-4 (400V)	A	70	
Rated operational power AC-3 (T≤55°C)	230V	kW	45	
	400V	kW	75	
	415V	kW	75	
	440V	kW	75	
	500V	kW	90	
	690V	kW	110	
	1000V	kW	55	
IEC max current I <sub>e</sub> in DC1 with L/R ≤ 1ms with 1 poles in series	≤24V	A	165	
	48V	A	165	
	75V	A	150	
	110V	A	10	
	220V	A	–	
	IEC max current I <sub>e</sub> in DC1 with L/R ≤ 1ms with 2 poles in series	≤24V	A	165
48V		A	165	
75V		A	165	
110V		A	150	
220V		A	14	
IEC max current I <sub>e</sub> in DC1 with L/R ≤ 1ms with 3 poles in series		≤24V	A	165
	48V	A	165	
	75V	A	165	
	110V	A	160	
	220V	A	150	
	IEC max current I <sub>e</sub> in DC1 with L/R ≤ 1ms with 4 poles in series	≤24V	A	165
48V		A	165	

	75V	A	165
	110V	A	165
	220V	A	165
<hr/>			
IEC max current Ie in DC3-DC5 with L/R ≤ 15ms with 1 poles in series	≤24V	A	165
	48V	A	60
	75V	A	44
	110V	A	6
	220V	A	–
<hr/>			
IEC max current Ie in DC3-DC5 with L/R ≤ 15ms with 2 poles in series	≤24V	A	165
	48V	A	82
	75V	A	70
	110V	A	80
	220V	A	7
<hr/>			
IEC max current Ie in DC3-DC5 with L/R ≤ 15ms with 3 poles in series	≤24V	A	165
	48V	A	195
	75V	A	110
	110V	A	120
	220V	A	120
<hr/>			
IEC max current Ie in DC3-DC5 with L/R ≤ 15ms with 4 poles in series	≤24V	A	165
	48V	A	130
	75V	A	130
	110V	A	150
	220V	A	150
<hr/>			
Short-time allowable current for 10s (IEC/EN60947-1)		A	1200
<hr/>			
Protection fuse	gG (IEC)	A	250
	aM (IEC)	A	160
<hr/>			
Making capacity (RMS value)		A	1500
<hr/>			
Breaking capacity at voltage	440V	A	1200
	500V	A	1025
	690V	A	905
<hr/>			
Resistance per pole (average value)		mΩ	0.45
<hr/>			
Power dissipation per pole (average value)	Ith	W	12
	AC3	W	10.1
<hr/>			
Tightening torque for terminals	min	Nm	6
	max	Nm	7
	min	lbin	4.4
	max	lbin	5.2
<hr/>			
Tightening torque for coil terminal	min	Nm	0.8
	max	Nm	1
	min	lbin	0.59
	max	lbin	0.74
<hr/>			
Conductor section	AWG/Kcmil		
	max		2/0

Flexible w/o lug conductor section	min	mm <sup>2</sup>	1.5
	max	mm <sup>2</sup>	70
Flexible c/w lug conductor section	min	mm <sup>2</sup>	1.5
	max	mm <sup>2</sup>	70
Power terminal protection according to IEC/EN 60529			IP20 front
<b>Mechanical features</b>			
Operating position	normal allowable		Vertical plan ±30°
Fixing			Screw / DIN rail 35mm
Weight		g	2020
Conductor section	AWG/kcmil conductor section		
	max		2/0
<b>Operations</b>			
Mechanical life		cycles	15000000
Electrical life		cycles	800000
<b>Safety related data</b>			
EMC compatibility			yes
<b>AC coil operating</b>			
Rated AC voltage at 50/60Hz		V	24
AC operating voltage	of 50/60Hz coil powered at 50Hz		
	pick-up		
	min	%Us	80
	max	%Us	110
	drop-out		
	min	%Us	20
	max	%Us	55
	of 50/60Hz coil powered at 60Hz		
	pick-up		
	min	%Us	85
	max	%Us	110
	drop-out		
	min	%Us	40
	max	%Us	55
AC average coil consumption at 20°C	of 50/60Hz coil powered at 50Hz		
	in-rush	VA	300
	holding	VA	20
	of 50/60Hz coil powered at 60Hz		
	in-rush	VA	275
	holding	VA	17
	of 60Hz coil powered at 60Hz		
	in-rush	VA	300
	holding	VA	20
Dissipation at holding ≤20°C 50Hz		W	6.5
<b>Max cycles frequency</b>			
Mechanical operation		cycles/h	1500
<b>Operating times</b>			
Average time for Us control			

in AC

Closing NO

min	ms	45
max	ms	32

Opening NO

min	ms	9
max	ms	24

**UL technical data**

Yielded mechanical performance

for three-phase AC motor

200/208V	HP	50
220/230V	HP	50
460/480V	HP	100
575/600V	HP	125

General USE

Contactor

AC current	A	165
------------	---	-----

Short-circuit protection fuse, 600V

High fault

Short circuit current	kA	100
Fuse rating	A	200
Fuse class		J

Standard fault

Short circuit current	kA	10
Fuse rating	A	250
Fuse class		RK5

**Ambient conditions**

Temperature

Operating temperature

min	°C	-50
max	°C	70

Storage temperature

min	°C	-60
max	°C	80

Max altitude

m	3000
---	------

**Dimensions [mm (in)]**

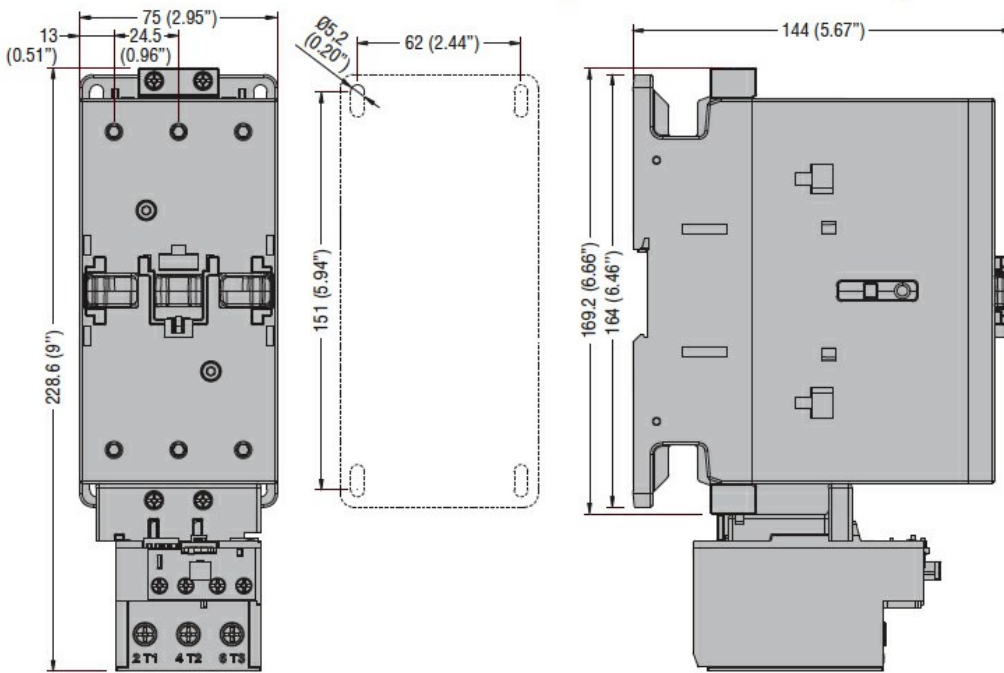

### Wiring diagrams

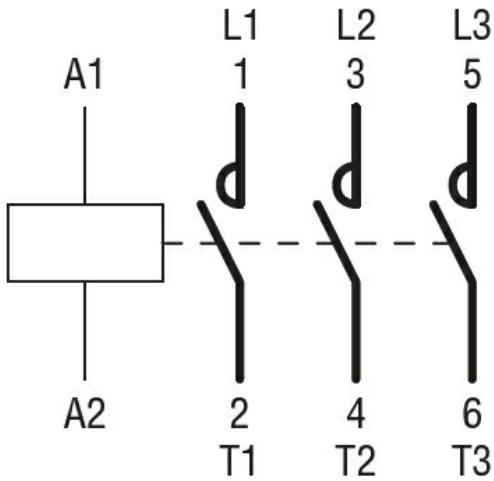

### Certifications and compliance

#### Compliance

CSA C22.2 n° 60947-1

CSA C22.2 n° 60947-4-1

IEC/EN/BS 60947-1

IEC/EN/BS 60947-4-1

UL 60947-1

UL 60947-4-1

#### Certificates

CCC

cULus

### ETIM classification

ETIM 8.0

EC000066 -  
Power contactor,  
AC switching