



Add-on blocks and accessories
- 1 changeover contact
P1X1011
1 C/O
0.5
IEC/EN/BS
60947-5-1

Product designation

Product type designation

Number of poles

Number of DIN modules

Compliance

Electrical features

Rated impulse withstand voltage Uimp	kV	4
Rated operational voltage AC (IEC)	VAC	400
Rated current (In)	A	6
Conductivity		24V 10mA

Ambient conditions

Operating temperature	min	°C	-40
	max	°C	+70
Storage temperature	min	°C	-40
	max	°C	+80

Mechanical features

Operating position	normal allowable	Vertical plan	Any
Tightening torque for terminals	min	Nm	1
	max	Nm	1
	min	lbin	0.7
	max	lbin	0.7
Terminals tool			PH2
Conductor section	IEC		
	max	mm ²	1x 2.5 - 2x 1.5
Weight		g	40

Dimensions [mm (in)]

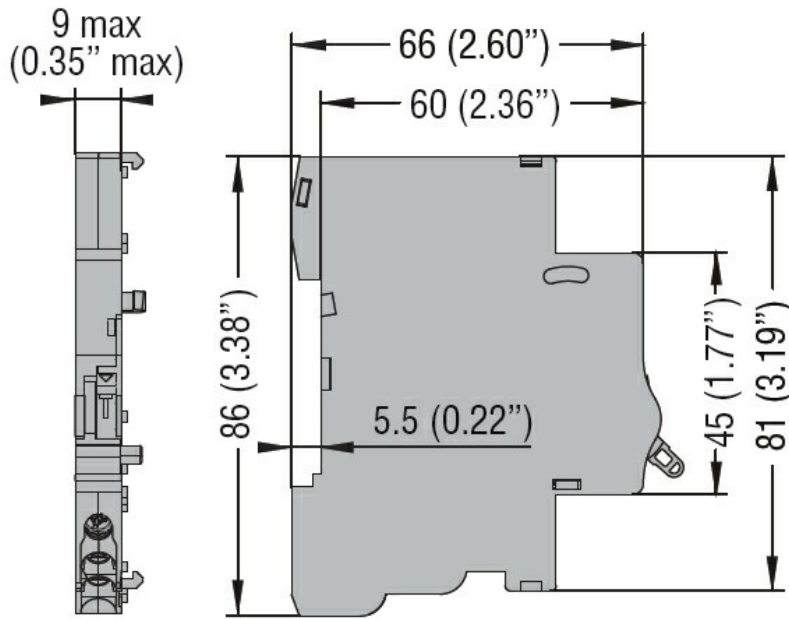

Wiring diagrams

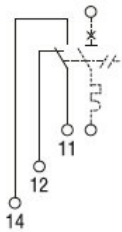

Certifications and compliance

Compliance

IEC/EN 60947-5-1. UR "UL Recognized" per Canada e USA.

Certifications

cULus
 EAC

ETIM classification

ETIM 8.0

EC000041 -
 Auxiliary contact
 block