

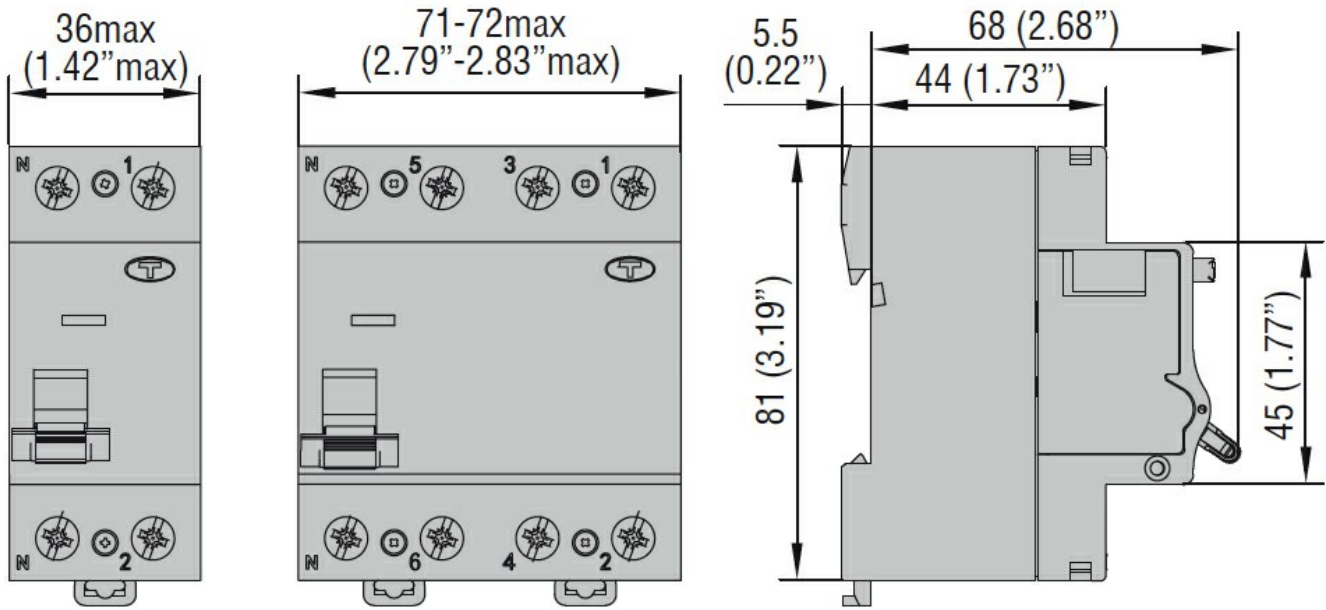

Product designation	Residual current circuit breakers (RCCB)		
Product type designation	P1RD		
Number of poles	4P		
Number of DIN modules	4		
Compliance	IEC		
Electrical features			
Rated insulation voltage U_i IEC/EN	V	400	
Rated impulse withstand voltage U_{imp}	kV	4	
Rated operational voltage AC (IEC)	VAC	230/400	
Rated frequency	Hz	50/60	
Rated current (I_n)	A	63	
Residual operation characteristic	A		
Rated residual current	mA	30	
Short circuit rating (IEC)	kA	10	
Electrical life	cycles	10000	
Ambient conditions			
Operating temperature	min	°C	-25
	max	°C	+60
Storage temperature	min	°C	-40
	max	°C	+80
Max altitude	m	2000	
Mechanical features			
Operating position	normal		Vertical plan
			35mm DIN rail
Fixing	35mm DIN rail		
Tightening torque for terminals	max	Nm	2
	max	lbin	15
Terminals tool	Pz 2		
Conductor section	IEC		
	min	mm ²	2.5
	max	mm ²	35
	AWG/Kcmil		
	min	14	
	max	2	
Mechanical life	cycles	20000	
Weight	g	326	
Frontal IP degree	IP20		
Pollution degree	2		
Dimensions [mm (in)]			



Certifications and compliance

Compliance

IEC/EN/BS 61008-1

Certifications

EAC

TÜV-SUD

ETIM classification

ETIM 8.0

EC000003 -
 Residual current
 circuit breaker
 (RCCB)