

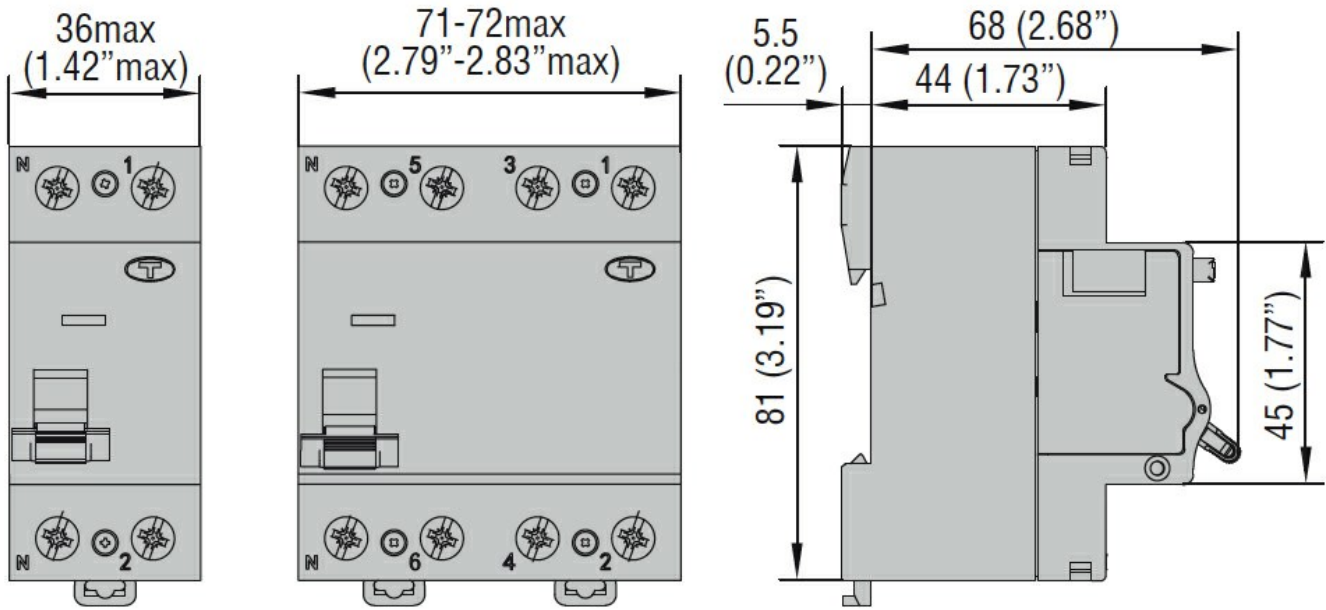

Product designation	Residual current circuit breakers (RCCB)		
Product type designation	P1RD		
Number of poles	2P		
Number of DIN modules	2		
Compliance	IEC		
Electrical features			
Rated insulation voltage U_i IEC/EN	V	400	
Rated impulse withstand voltage U_{imp}	kV	4	
Rated operational voltage AC (IEC)	VAC	230	
Rated frequency	Hz	50/60	
Rated current (I_n)	A	40	
Residual operation characteristic		AC	
Rated residual current	mA	30	
Short circuit rating (IEC)	kA	10	
Electrical life	cycles	10000	
Ambient conditions			
Operating temperature	min	°C	-25
	max	°C	+60
Storage temperature	min	°C	-40
	max	°C	+80
Max altitude		m	2000
Mechanical features			
Operating position	normal		Vertical plan
			35mm DIN rail
Fixing	35mm DIN rail		
Tightening torque for terminals	max	Nm	2
	max	lbin	15
Terminals tool	Pz 2		
Conductor section	IEC	min	mm ² 2.5
		max	mm ² 35
	AWG/Kcmil	min	14
		max	2
Mechanical life		cycles	20000
Weight		g	185
Frontal IP degree	IP20		
Pollution degree	2		
Dimensions [mm (in)]			



Certifications and compliance

Compliance

IEC/EN/BS 61008-1

Certifications

EAC

TÜV-SUD

ETIM classification

ETIM 8.0

EC000003 -
 Residual current
 circuit breaker
 (RCCB)