

AMG ELM-4F EX**Weidmüller Interface GmbH & Co. KG**

Klingenbergstraße 26

D-32758 Detmold

Germany

www.weidmueller.com



Similar to illustration

Efficient machine and facility operation calls for fail-safe and maintenance-friendly control voltage distribution that can be installed in a time and space-saving manner.

With the new maxGUARD system, the terminal blocks (previously installed separately) for distributing potential to the outputs of the electronic load monitors become an integral part of a 24 V DC control voltage distribution system.

The innovative combination of load monitoring and potential distribution saves time during installation, increases safety against failure and reduces the amount of space required on the terminal rail by 50%.

General ordering data

Version	Electronic load monitoring, 4 A, 24 V DC
Order No.	2082060000
Type	AMG ELM-4F EX
GTIN (EAN)	4050118419597
Qty.	1 pc(s).

AMG ELM-4F EX

Weidmüller Interface GmbH & Co. KG

Klingenbergstraße 26

D-32758 Detmold

Germany

www.weidmueller.com

Technical data

Dimensions and weights

Depth	96.5 mm	Depth (inches)	3.799 inch
Height	125 mm	Height (inches)	4.921 inch
Width	6.1 mm	Width (inches)	0.24 inch
Net weight	40 g		

Temperatures

Storage temperature	-40 °C...85 °C	Operating temperature	-25 °C...70 °C
---------------------	----------------	-----------------------	----------------

Input

Current consumption (full load)	I _{OUT} +30 mA	Current consumption (idle)	25 mA
DC input voltage range	18...30 V DC	Input fuse (internal)	Yes
Rated input voltage	24 V DC	Surge protection	Suppressor diode
max. admissible residual ripple at the input	100 mVpp		

Output

Adjustable rated current	No	Capacitive load	10,000 µF
Connection system	PUSH IN	Rated current	4 A
Surge protection	Suppressor diode	Switch-on delay	1 s
Triggering characteristic	see characteristic curve		

General data

Conformal coating	Yes		
Function key	Activation time <3s, Reset, ON		
MTTF	According to Standard	SN 29500	
	Operating time (hours), min.	3,063,000 h	
	Ambient temperature	40 °C	
	Input voltage	24 V	
	Output power	96 W	
	Duty cycle	100 %	
Power loss, idling	415 mW		
Power loss, nominal load	775 mW		
Protection degree	IP20		
Relay to activate the output	No		
Surge voltage category	III		

Insulation coordination

Surge voltage category	III
------------------------	-----

Connection data (output)

Conductor cross-section, AWG/kcmil , max.	12 AWG	Conductor cross-section, AWG/kcmil , min.	26 AWG
Conductor cross-section, flexible , max.	2.5 mm ²	Conductor cross-section, flexible , min.	0.14 mm ²
Conductor cross-section, rigid , max.	2.5 mm ²	Conductor cross-section, rigid , min.	0.14 mm ²
Connection system	PUSH IN	Number of terminals	2 (+ / -)
Screwdriver blade	0.6 x 3.5		

AMG ELM-4F EX

Weidmüller Interface GmbH & Co. KG
 Klingenbergstraße 26
 D-32758 Detmold
 Germany

www.weidmueller.com

Technical data

Signalling

LED green	Red LED	Load monitoring has disconnected, Load monitoring has triggered (flashing), Internal error (rapid flashing)
Operation (failure-free)		

Approbations

Certificate No. (ATEX)	DEMKO17ATEX1870X	Certificate no. (cULus)	E258476
Certificate no. (cULusEX)	E470829	Institute (cULus)	CULUS
Institute (cULusEX)	CULUSEX	Institute(ATEX)	DEMKOATEX

Classifications

ETIM 6.0	EC002057	ETIM 7.0	EC002057
ETIM 8.0	EC002057	ETIM 9.0	EC001437
ECLASS 9.0	27-37-10-16	ECLASS 9.1	27-37-10-16
ECLASS 10.0	27-37-10-16	ECLASS 11.0	27-37-10-16
ECLASS 12.0	27-37-10-16	ECLASS 13.0	27-37-10-16

Environmental Product Compliance

REACH SVHC	Lead 7439-92-1
SCIP	a7fff16c-85aa-4fb0-a206-7be03f41b0b7

Approvals

Approvals



ROHS	Conform
UL File Number Search	UL Website
Certificate no. (cULus)	E258476
Certificate no. (cULusEX)	E470829

AMG ELM-4F EX

Weidmüller Interface GmbH & Co. KG
Klingenbergstraße 26
D-32758 Detmold
Germany

www.weidmueller.com

Technical data**Downloads**

Approval/Certificate/Document of Conformity	MaxGuard AMG ELM EX UL 61010-1 .pdf MaxGuard AMG ELM EX UL C1D2 .pdf MaxGuard AMG ELM UL 508 CSA C22.2.pdf MaxGuard EX ATEX .pdf BV Certificate DNV Certificate ABS Certificate RINA Certificate Declaration of Conformity UK Conformity Assessed
Engineering Data	CAD data – STEP
Product Change Notification	Release-Notes
User Documentation	Manual_maxGUARD Operating instructions
Catalogues	Catalogues in PDF-format

AMG ELM-4F EX

Weidmüller Interface GmbH & Co. KG
Klingenbergstraße 26
D-32758 Detmold
Germany

www.weidmueller.com

Drawings

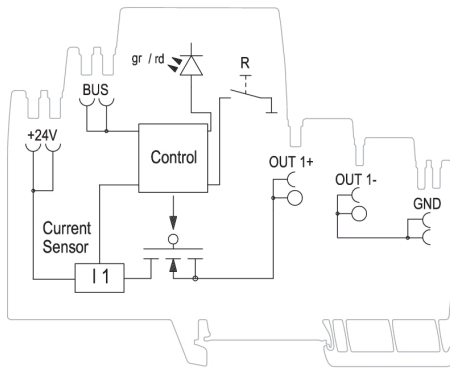

Schematic circuit diagram

Tripping characteristic normal

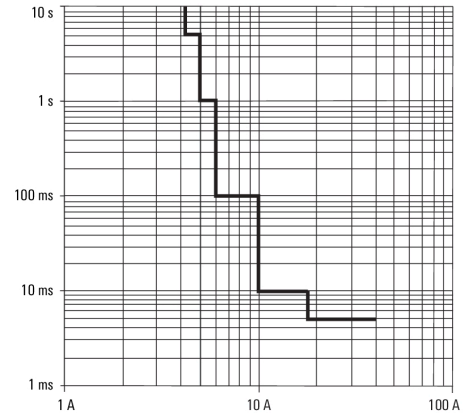

Tripping characteristic