



L40E-11MA1A

L4000 Systems

SAFETY SINGLE-BEAM SENSORS

SICK
Sensor Intelligence.



Ordering information

Type	part no.
L40E-11MA1A	6027342

Other models and accessories → www.sick.com/L4000_Systems



Detailed technical data

Features

Scanning range	7 m
Number of beams	1
Detection capability	30 mm
Optical axis	Radial
Response time	0.4 ms
Response time	0.4 ms + Test device response time (UE401)

Safety-related parameters

Type	Type 4 (IEC 61496-1) ¹⁾
Safety integrity level	SIL 3 (IEC 61508) ¹⁾
Category	Category 4 (EN ISO 13849) ¹⁾
Performance level	PL e (EN ISO 13849) ¹⁾
PFH_D (mean probability of a dangerous failure per hour)	2.9×10^{-10} (EN ISO 13849) ¹⁾
T_M (mission time)	20 years (EN ISO 13849) ¹⁾

¹⁾ Only in conjunction with UE401.

Interfaces

Connection type	Male connector M12, 4-pin, straight
Display elements	LED

Electronics

Protection class	III (IEC 61140)
Supply voltage V_S	24 V DC (19.2 V DC ... 28.8 V DC)
Power consumption	≤ 30 mA

Mechanics

Design	Cylindrical
---------------	-------------

Dimensions (diameter x length)	M18 x 107.7 mm
Housing material	Nickel-plated brass
Lens material	Glass
Weight	67 g

Ambient data

Enclosure rating	IP67 (EN 60529)
Ambient operating temperature	-20 °C ... +55 °C
Storage temperature	-25 °C ... +75 °C
Air humidity	15 % ... 95 %, Non-condensing
Vibration resistance	5 g, 10 Hz ... 55 Hz (IEC 60068-2-6)
Shock resistance	10 g, 16 ms (IEC 60068-2-27)

Other information

Aperture angle/receiving angle	± 2.5° / ± 2.5°
---------------------------------------	-----------------

Certificates

EU declaration of conformity	✓
UK declaration of conformity	✓
ACMA declaration of conformity	✓
Moroccan declaration of conformity	✓
China-RoHS	✓
cULus certificate	✓
EC-Type-Examination approval	✓

Classifications

ECLASS 5.0	27272701
ECLASS 5.1.4	27272701
ECLASS 6.0	27272701
ECLASS 6.2	27272701
ECLASS 7.0	27272701
ECLASS 8.0	27272701
ECLASS 8.1	27272701
ECLASS 9.0	27272701
ECLASS 10.0	27272701
ECLASS 11.0	27272701
ECLASS 12.0	27272701
ETIM 5.0	EC001831
ETIM 6.0	EC001831
ETIM 7.0	EC001831
ETIM 8.0	EC001831
UNSPSC 16.0901	46171620



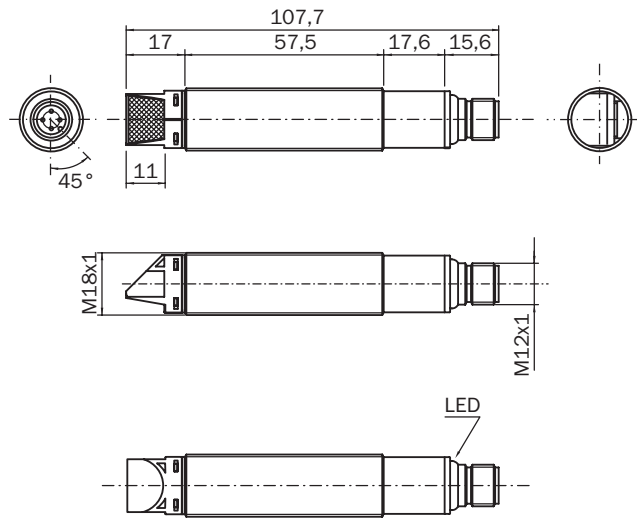

Dimensional drawing M18, radial, straight







Dimensions in mm (inch)

Recommended accessories

Other models and accessories → www.sick.com/L4000_Systems

	Brief description	Type	part no.
Mounting systems			
	<ul style="list-style-type: none"> Description: Mounting bracket for M18 sensors Material: Steel Details: Steel, zinc coated Items supplied: Without mounting hardware Suitable for: GR18, V180-2, V18, W15, Z1, Z2 	BEF-WN-M18	5308446
reflectors and optics			
		PNS75-008	1026647
		PSK1	1005229
		PSK45	5306053

	Brief description	Type	part no.
system plugs and extension modules			
	<ul style="list-style-type: none"> Applications: Evaluation unit Description: UE401 evaluation unit Compatible sensor types: L4000 Systems single-beam photoelectric safety switches Mounting: Snap-on mounting on 35 mm mounting rail according to EN 60715 	UE401-A0010	6027343
connectors and cables			
	<ul style="list-style-type: none"> Connection type head A: Female connector, M12, 4-pin, angled, A-coded Connection type head B: Flying leads Signal type: Sensor/actuator cable Cable: 5 m, 4-wire, PVC Description: Sensor/actuator cable, unshielded Application: Zones with chemicals, Uncontaminated zones 	YG2A14-050VB3XLEAX	2095897
	<ul style="list-style-type: none"> Connection type head A: Female connector, M12, 4-pin, straight, A-coded Connection type head B: Flying leads Signal type: Sensor/actuator cable Cable: 5 m, 4-wire, PVC Description: Sensor/actuator cable, unshielded Application: Zones with chemicals, Uncontaminated zones 	YF2A14-050VB3XLEAX	2096235
	<ul style="list-style-type: none"> Connection type head A: Female connector, M12, 4-pin, straight, A-coded Description: Unshielded, Head A: female connector, M12, 4-pin, straight, unshielded, for power supply, for cable diameter 4 mm ... 6 mm Head B: - Connection systems: Screw-type terminals Permitted cross-section: ≤ 0.75 mm² 	DOS-1204-G	6007302
	<ul style="list-style-type: none"> Connection type head A: Female connector, M12, 4-pin, angled, A-coded Description: Unshielded, Head A: female connector, M12, 4-pin, angled, unshielded, for power supply, for cable diameter 3 mm ... 6.5 mm Head B: - Connection systems: Screw-type terminals Permitted cross-section: ≤ 0.75 mm² 	DOS-1204-W	6007303

SICK AT A GLANCE

SICK is one of the leading manufacturers of intelligent sensors and sensor solutions for industrial applications. A unique range of products and services creates the perfect basis for controlling processes securely and efficiently, protecting individuals from accidents and preventing damage to the environment.

We have extensive experience in a wide range of industries and understand their processes and requirements. With intelligent sensors, we can deliver exactly what our customers need. In application centers in Europe, Asia and North America, system solutions are tested and optimized in accordance with customer specifications. All this makes us a reliable supplier and development partner.

Comprehensive services complete our offering: SICK LifeTime Services provide support throughout the machine life cycle and ensure safety and productivity.

For us, that is “Sensor Intelligence.”

WORLDWIDE PRESENCE:

Contacts and other locations –www.sick.com