

SPARTAN LED Zone 2/22 SPZ High Output Linear Luminaire

rayTEC®

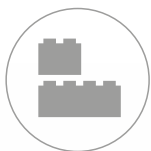

Modular Design

Key components such as the LED and PSU modules are easily accessible for straightforward maintenance and inspection.



Power and Performance

High lumen output up to 14 kilolumens and a range of beam patterns to effectively light up large open areas.



Retrofitable

Linear has been designed with the same dimensions, fixing centres and cable entries as traditional fluorescent fittings making it a direct replacement.



Controllable

DALI 2.0 Dimmable as an option on non emergency variants for precise and flexible control of lighting assets.

5 YEAR WARRANTY

All Raytec luminaires are provided with an industry leading 5 year warranty and have an expected useful life in excess of 10 years. See Warranty Statement for details.



Technical Specifications

Certification

ATEX Rating	ATEX UKEX and IEC Ex rated for Gas and Dust
Hazardous Area Rating	Zone 2 (Gas), Zone 22 (Dust) (Zone 21 Version also available: Zone 2 (Gas) Zone 21/22 (Dust))
Certificates	Zone 2/22 version: CML15ATEX4138 & IEC Ex CML15.0068 & CML21UKEX4104 (Zone 21 version: CML16ATEX1130 & IEC Ex CML16.0052 & CML21UKEX1100)
Gas	Gas: II 3 G D Ex ec mc IIC T4 Gc Ta= -40°C to +60°C (-20°C to +50°C for emergency variants)
Dust	Ex tc IIIC T80°C Dc Ta= -40°C to +60°C (-20°C to +50°C for emergency variants)
Dust (Zone 21 Version)	II 2 D Ex tb IIIC T80°C Db Ta= -40°C to +60°C (-20°C to +50°C for emergency variants)
ABS Certificate #	#25-0220600-PDA

Electrical

	WL84	WL84 Emergency	WL168
Input	Standard: 110-254V 50/60Hz AC/DC Optional: 110-277V 50/60Hz AC/DC	110-254V 50/60Hz AC only	Standard: 110-254V 50/60Hz AC/DC Optional: 110-277V 50/60Hz AC/DC
Power	48W	56W	96W
Termination	Incoming terminal block suitable for looping 4 core 4mm ² cable (6mm ² available - POA)		
Power Factor	>0.95		
Cable Entries	SPARTAN Linear comes with 2 M20 cable entries at each end of the product, 4 total (Other entries available upon request) Dispatched complete with three ATEX/IEC Ex/UKEX approved blanking plugs		
DALI	Non-Emergency and non Low voltage products are available as DALI 2.0 enabled as an option. In these variants terminals are provided for loop in/loop out 2 core control cable		

Optical

	WL84	WL84 Emergency	WL168
Lumen output on mains	Up to 7048		Up to 14096
LED type	Platinum Elite SMT LEDs		
Number of LEDs	80		160
CRI	80+		
Colour Temperature	6500K standard		

Mechanical

	WL84	WL84 Emergency	WL168
Burning Position	Universal		
IP Rating	IP66 & IP67		
IK Rating	IK10		
Temperature Range	-40°C to +60°C (-40°F to + 140°F)	-20°C to +50°C (-4°F to + 122°F)	-40°C to +60°C (-40°F to + 140°F)
Weight	6kg (13.2lbs)	7kg (15.4lbs)	10kg (22lbs)

Technical Specifications

Mechanical

Enclosure	Marine grade aluminium epoxy powder coated, UV stabilised polycarbonate, all external fasteners and brackets are marine grade stainless steel
Unit Colour	Silver (RAL 9006) Emergency Cover - Red (RAL 3024)
Installation instructions	Please see document 0920-D-00042 at www.raytecltd.com
Spare Part Information	Please contact Raytec for information and spare part availability.
Dimensions	See dimensional sketches
Mounting	Via M8/M6 tapped holes. Various mounting arrangements available (please see product overview guide)
Sustainability	EPD - EPD no. HUB-3730, verified by EPD Hub TM66 Circularity Score - 2.0

Intelligent Emergency

WL84 Emergency

Function	Self-testing intelligent emergency
System health indicator	Tri-colour LED indicator
Emergency Duration	3hrs @ 25% power Other options available
Emergency Battery	Ni/Cd 12V
Emergency Charge Time	20 hours

Light Distribution

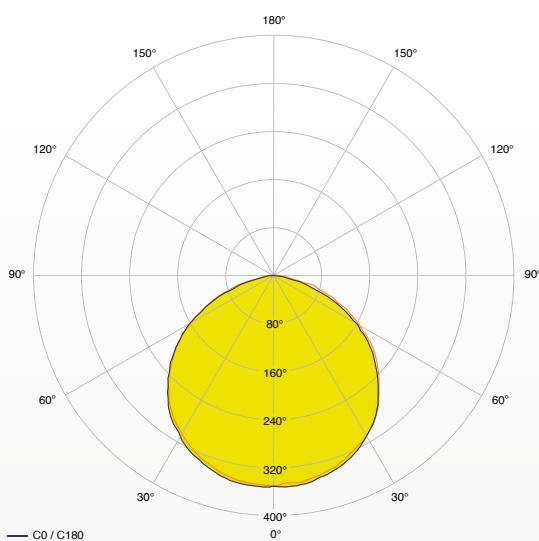

Zone 2

Symmetrical Optics

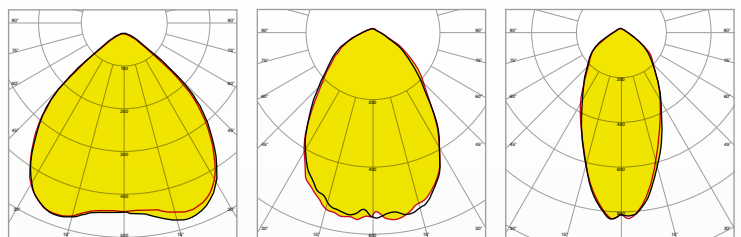

90x90

60x60

30x30

Asymmetrical Optics

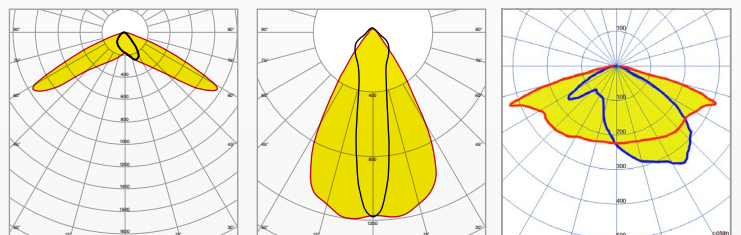

Wide Beam

**Aisle -
80x30**

**PP3
Optic**

Product Dimensions

WL84

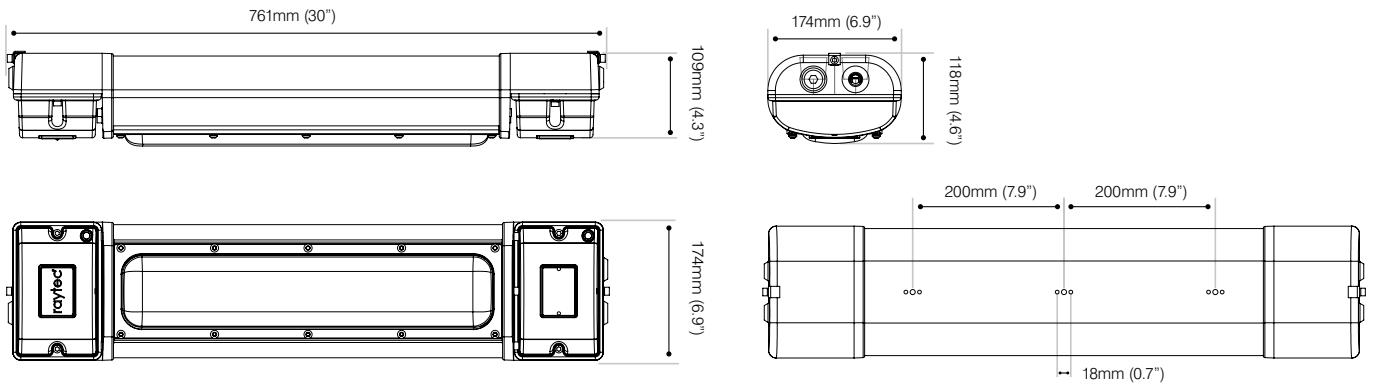

WL84-EMX

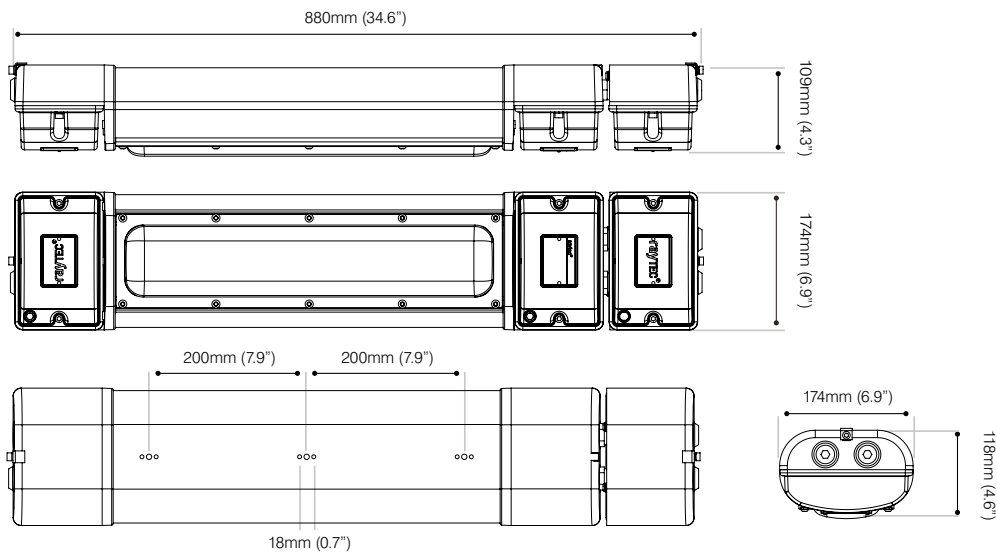

WL168

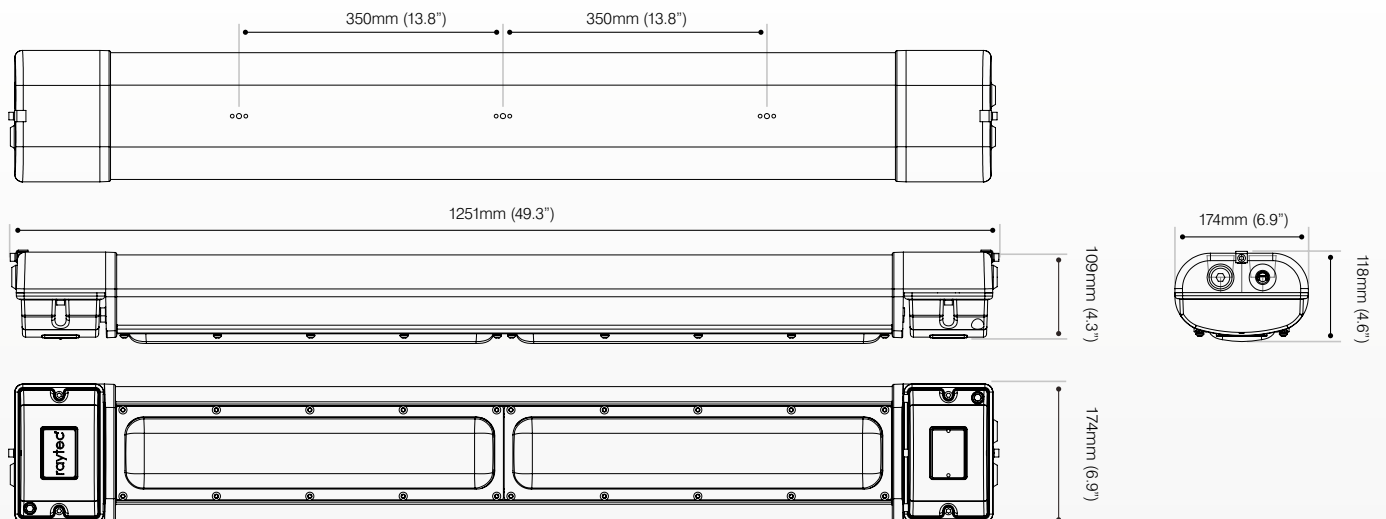

Part Code Builder

SPARTAN High Output Linear Zone 2 Family

Example - SPZ-WL84-HO

Family	Model	Emergency/DALI	CCT	Optics	Power	Entry
SPZ	WL84-HO	Not Stated - Non EM	Not Stated - 6500K	Not Stated - Standard	Not Stated - 110-254V	Not Stated - M20
	WL168-HO	EMX25 - (25% for 3 hours) (WL84 only)	4K - 4000K	Other optics available - please contact Raytec	277 - 110-277V	M25
		DA - DALI				

*Alternative versions available. Please contact Raytec for details.

SPARTAN Linear Specials



Wildlife-Friendly Variants

- Amber LED technology designed to protect wildlife in coastal locations or natures reserves.
- Dominant wavelength: 600nm

Example ordering code: SPZ-WL168-HO-4K-A

Other options available, contact Raytec for full ordering information



See SPARTAN Linear Mounting & Accessories Guide for full range of accessories

Disclaimer

The information provided in this document was accurate at the time of its creation. However, due to the evolving nature of our products and continuous improvements, there may be changes or updates that occur after its publication. For the most current and detailed information about our products, please contact our sales team at sales@rayteclcd.com.