

Plastic enclosures

Position switches Plastic IN73



2 OR 4 CONTACTS

Good to know ...

Our new standard switch, the IN73, is the latest in our ENK-series. It offers a modular, robust enclosure and a wide range of actuators made of metal. In mechanical and plant engineering, it is used as a position and safety switch in rough environments as it features additional fixing holes to achieve a better installation.

The “big brother” of the IN65, it has a similar modular design, however there is an important difference: Whereas the C14 switch insert (introduced on page 37) has 2 contacts, the IN73 can be equipped with the C17 switch insert with 4 contacts.

The modular design and the easy way to change the actuator allows for a great variety of applications, for example for monitoring doors, hoods, and flaps, or for detecting the position of moving machine parts. The IN73 is as cost effective as a plastic enclosed switch, robust to install like a metal switch, and clever due to its modular design and easy to change actuators.

Technical design

- Slow- and snap-action
- **Versions:**
 - With C14 switch insert: 2 NC, 2 NO, 1 NC/1 NO
 - With C17 switch insert: 4 NO, 4 NC, 2 NO/2 NC
 - 1 NC/3 NO and 3 NC/1 NO

Technical data

Electrical data		
Design insulation voltage	U_i max.	400 V AC
Conventional thermoelectric current (up to) ^①	I_{the}	5 A
Rated operating voltage	U_e max.	240 V AC
Utilisation category (up to) ^①		AC-15, U_e/I_e 240 V/3 A DC-13 U_e/I_e 24 V/1.5 A
Short-circuit protection (up to) ^①		Safety fuse 4 A gG
Protection class		II, protective insulation
Mechanical data		
Enclosure/Cover material		Thermoplastics, glass-fibre reinforced (UL 94-V0)
Ambient temperature		-30 °C to +75 °C
Mechanical lifetime (up to) ^①		10 × 10 ⁶ switching cycles
B10d NC Contact cycles (up to) ^①		20 million
B10d NO Contact cycles (up to) ^①		1 million
Switching frequency		≤ 60/min.
Type of connection		4 screwed connections (M3)
Conductor cross-sections		Single-wire 0.5 – 1.5 mm ² or strand with wire-end ferrule 0.5 – 1.5 mm ²
Cable entry		1 × M20 × 1.5
Protection class		IP66/IP67 according to EN 60529; DIN VDE 0470 T1
Standards		
VDE 0660 T211, DIN EN 60947-5-4, IEC 60947-5-4		
DIN EN ISO 13849-1, DIN EN ISO 13849-2		

① Depending on switching system and actuator (applicable values in data sheet)

Product characteristics

- High reliability at low currents (1 mA/24 VDC)
- Up to 4 contacts
- Actuator and installation collar with mounting holes made of metal
- Easy turning (8 x 45°) and changing of the actuators without a tool
- Standard switch and standard actuator according to DIN EN 50041
- Protection class IP66 and IP67 according to EN 60529



Options

- Available with an M12 connector
- On request, available with customised cables and connectors

Mounting

- 2 oval holes for adjustment for M5 screws
- 2 round holes for M5 screws for fixing when used for safety applications

POSITION SWITCHES PLASTIC IN73

IN73-... SM

Replacement actuator: 3918022415

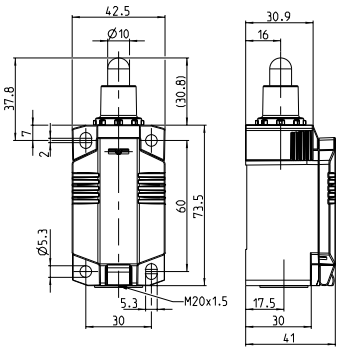

	1 NC / 1 NO	2 NC	2 NO	2 NC / 2 NO
--	-------------	------	------	-------------

Slow-action system

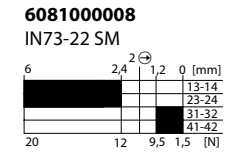
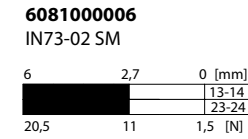
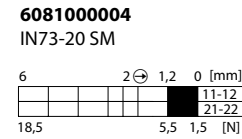
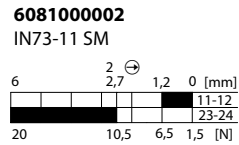

Snap-action system

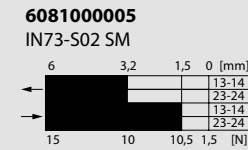
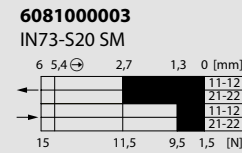
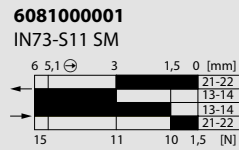

	4 NC	4 NO	3 NC / 1 NO	1 NC / 3 NO	1 NC / 1 NO overlapping
--	------	------	-------------	-------------	-------------------------

Slow-action system

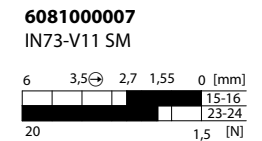
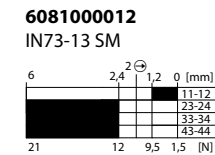
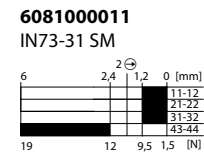
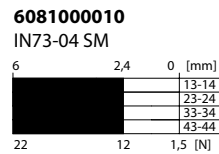
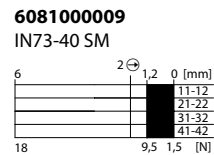



Replacement actuator: 3918172417

IN73-... RM

	1 NC / 1 NO	2 NC	2 NO	2 NC / 2 NO
--	-------------	------	------	-------------

Slow-action system

6081000014
IN73-11 RM

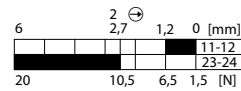

6081000016
IN73-20 RM

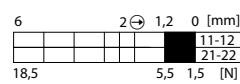

6081000018
IN73-02 RM



6081000020
IN73-22 RM

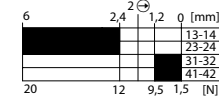

Snap-action system

6081000013
IN73-S11 RM



6081000015
IN73-S20 RM

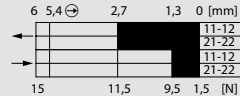

6081000017
IN73-S02 RM

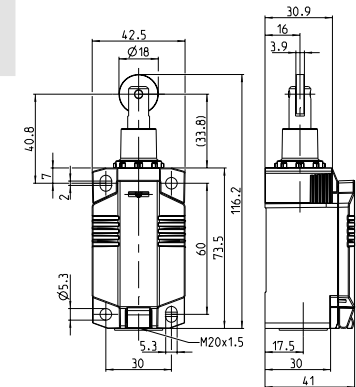
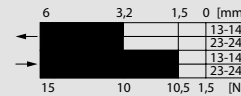

	4 NC	4 NO	3 NC / 1 NO	1 NC / 3 NO	1 NC / 1 NO overlapping
--	------	------	-------------	-------------	-------------------------

Slow-action system

6081000021
IN73-40 RM

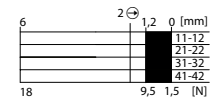

6081000022
IN73-04 RM

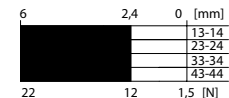

6081000023
IN73-31 RM

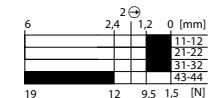

6081000024
IN73-13 RM

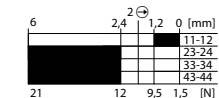

6081000019
IN73-V11 RM

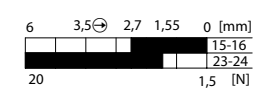

POSITION SWITCHES PLASTIC IN73

IN73-... HK

Replacement actuator: 3918202432

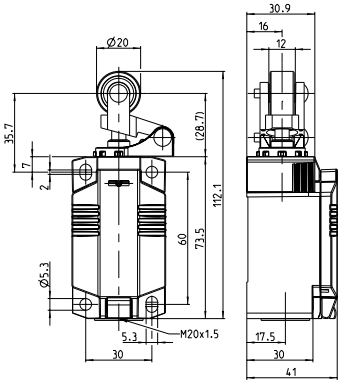
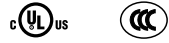

	1 NC / 1 NO	2 NC	2 NO	2 NC / 2 NO
--	-------------	------	------	-------------

Slow-action system

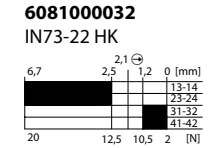
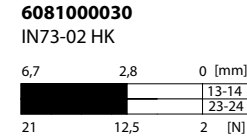
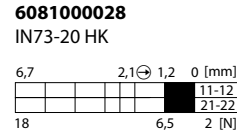
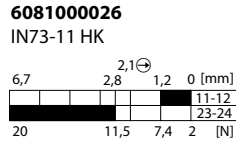

Snap-action system

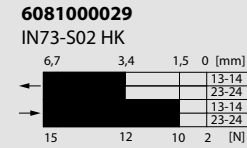
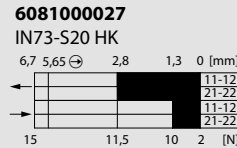
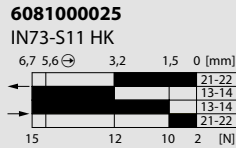

	4 NC	4 NO	3 NC / 1 NO	1 NC / 3 NO	1 NC / 1 NO overlapping
--	------	------	-------------	-------------	-------------------------

Slow-action system

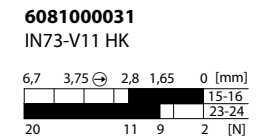
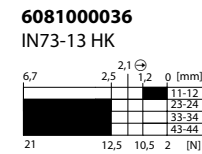
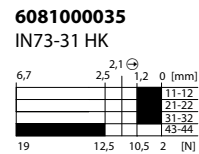
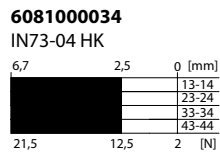
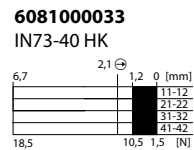



Replacement actuator: 3918202428

IN73-... DGHK

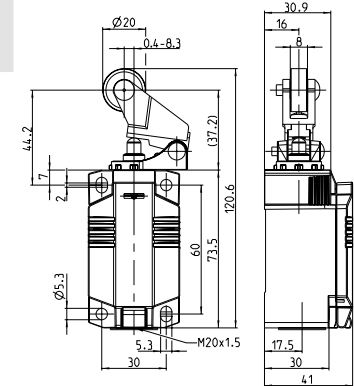

	1 NC / 1 NO	2 NC	2 NO	2 NC / 2 NO
--	-------------	------	------	-------------

Slow-action system

608100038
IN73-11 DGHK

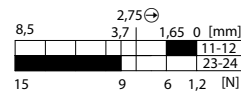

608100040
IN73-20 DGHK

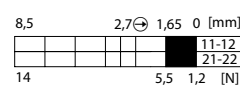

608100042
IN73-02 DGHK

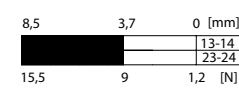

608100044
IN73-22 DGHK

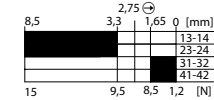

Snap-action system

608100037
IN73-S11 DGHK



608100039
IN73-S20 DGHK

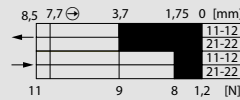

608100041
IN73-S02 DGHK



	4 NC	4 NO	3 NC / 1 NO	1 NC / 3 NO	1 NC / 1 NO overlapping
--	------	------	-------------	-------------	-------------------------

Slow-action system

608100045
IN73-40 DGHK

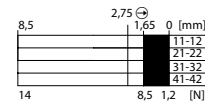

608100046
IN73-04 DGHK

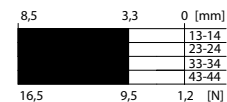

608100047
IN73-31 DGHK

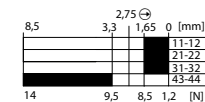

608100048
IN73-13 DGHK

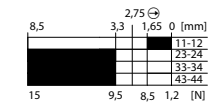

608100043
IN73-V11 DGHK

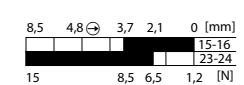

POSITION SWITCHES PLASTIC IN73

IN73-... DGKK

Replacement actuator: 3918202430

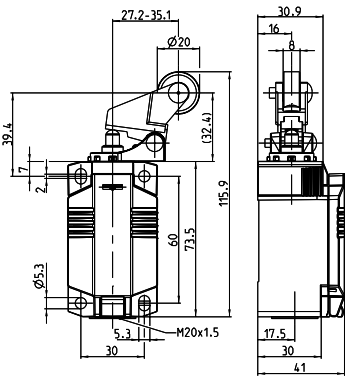

	1 NC / 1 NO	2 NC	2 NO	2 NC / 2 NO
--	-------------	------	------	-------------

Slow-action system	608100050 IN73-11 DGKK 7,5 3,4 2,6 1,55 0 [mm] 17,5 9,5 6 1,5 [N]	608100052 IN73-20 DGKK 7,5 2,6 1,55 0 [mm] 17 5,5 1,5 [N]	608100054 IN73-02 DGKK 7,5 3,4 0 [mm] 20 10 1,5 [N]	608100056 IN73-22 DGKK 7,5 3,05 2,6 1,55 0 [mm] 18 10 8,5 1,5 [N]
--------------------	---	---	---	---

Snap-action system	608100049 IN73-S11 DGKK 7,5 6,5 3,8 1,95 0 [mm] 14 9,5 8,5 1,5 [N]	608100051 IN73-S20 DGKK 7,5 6,85 3,4 1,65 0 [mm] 14 9,5 8 1,5 [N]	608100053 IN73-S02 DGKK 7,5 4,1 1,95 0 [mm] 14 10 8,5 1,5 [N]
--------------------	--	---	---

	4 NC	4 NO	3 NC / 1 NO	1 NC / 3 NO	1 NC / 1 NO overlapping
--	------	------	-------------	-------------	-------------------------

Slow-action system	608100057 IN73-40 DGKK 7,5 2,6 1,55 0 [mm] 17 8,5 1,5 [N]	608100058 IN73-04 DGKK 7,5 3,05 0 [mm] 20 10 1,5 [N]	608100059 IN73-31 DGKK 7,5 3,05 2,6 1,55 0 [mm] 17,5 10 8,5 1,5 [N]	608100060 IN73-13 DGKK 7,5 3,05 2,6 1,55 0 [mm] 19,5 10 8,5 1,5 [N]	608100055 IN73-V11 DGKK 7,5 4,5 3,4 2 0 [mm] 18 9 7 1,5 [N]
--------------------	---	--	---	---	---



Replacement actuator: 3918352393

IN73-... AHK

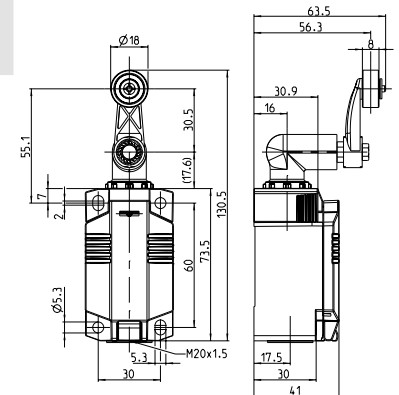

	1 NC / 1 NO	2 NC	2 NO	2 NC / 2 NO
--	-------------	------	------	-------------

Slow-action system

608100062
IN73-11 AHK

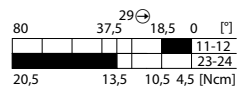

608100064
IN73-20 AHK

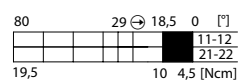

608100066
IN73-02 AHK

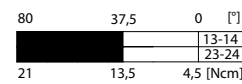

608100068
IN73-22 AHK

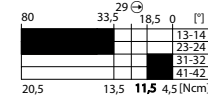

Snap-action system

608100061
IN73-S11 AHK

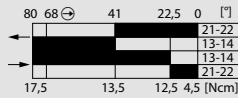

608100063
IN73-S20 AHK

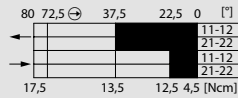

608100065
IN73-S02 AHK

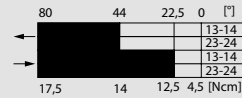

	4 NC	4 NO	3 NC / 1 NO	1 NC / 3 NO	1 NC / 1 NO overlapping
--	------	------	-------------	-------------	-------------------------

Slow-action system

608100069
IN73-40 AHK

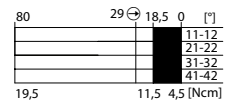

608100070
IN73-04 AHK

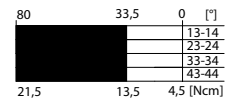

608100071
IN73-31 AHK

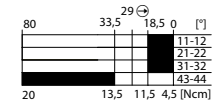

608100072
IN73-13 AHK

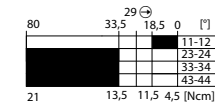

608100067
IN73-V11 AHK



POSITION SWITCHES PLASTIC IN73

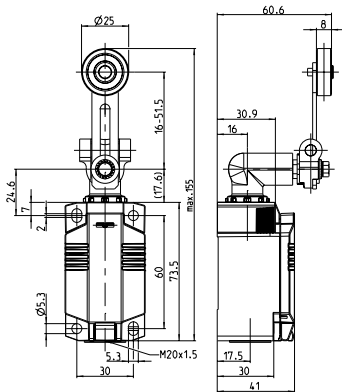

IN73-... AVK

Replacement actuator: 3918362424



	1 NC / 1 NO	2 NC	2 NO	2 NC / 2 NO
--	-------------	------	------	-------------

Slow-action system

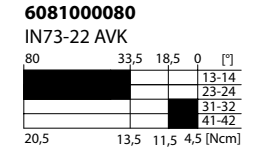
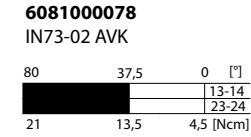
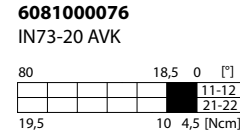
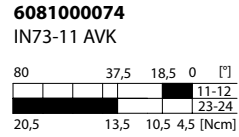

Snap-action system

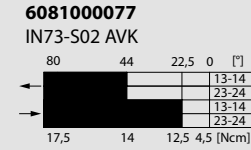
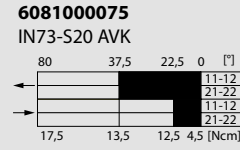
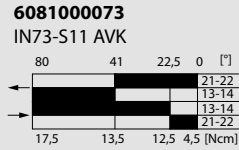

	4 NC	4 NO	3 NC / 1 NO	1 NC / 3 NO	1 NC / 1 NO overlapping
--	------	------	-------------	-------------	-------------------------

Slow-action system

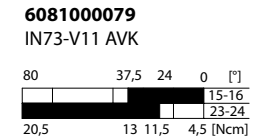
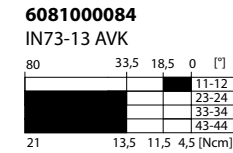
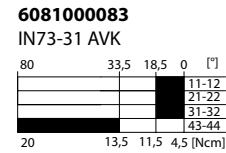
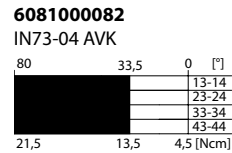
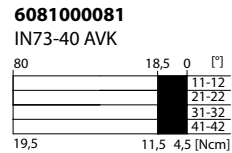



Replacement actuator: 3918372421

IN73-... AHDM



	1 NC / 1 NO	2 NC	2 NO	2 NC / 2 NO
Slow-action system	608100086 IN73-11 AHDM 	608100088 IN73-20 AHDM 	608100090 IN73-02 AHDM 	608100092 IN73-22 AHDM
Snap-action system	608100085 IN73-S11 AHDM 	608100087 IN73-S20 AHDM 	608100089 IN73-S02 AHDM 	

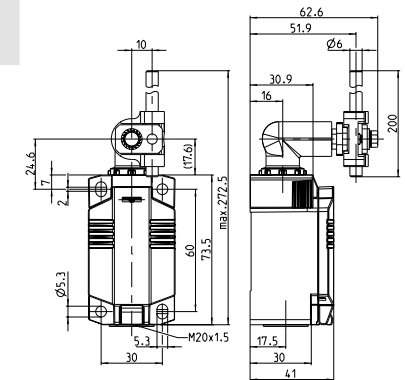

	4 NC	4 NO	3 NC / 1 NO	1 NC / 3 NO	1 NC / 1 NO overlapping
Slow-action system	608100093 IN73-40 AHDM 	608100094 IN73-04 AHDM 	608100095 IN73-31 AHDM 	608100096 IN73-13 AHDM 	608100091 IN73-V11 AHDM

POSITION SWITCHES PLASTIC IN73



IN73-... AHGU Ro50

Replacement actuator: 3918352422

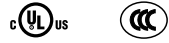

	1 NC / 1 NO	2 NC	1 NC / 1 NO overlapping
Slow-action system	<p>6081000109 IN73-11 AHGU Ro50</p> <p>26,5 19 16 7,5 [Ncm]</p>	<p>6081000110 IN73-20 AHGU Ro50</p> <p>26 15,5 7,5 [Ncm]</p>	<p>6081000111 IN73-V11 AHGU Ro50</p> <p>26,5 19 17 7,5 [Ncm]</p>
Snap-action system	<p>6081000108 IN73-S11 AHGU Ro50</p> <p>24 19 18 7,5 [Ncm]</p>		

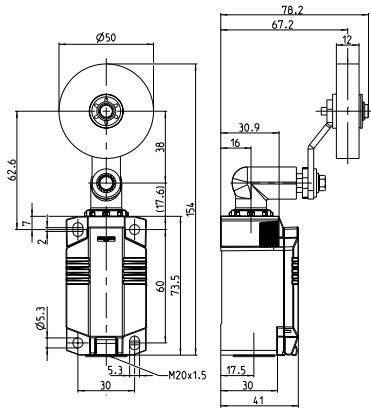



Replacement actuator: 3918362423

IN73-... AVGU RO50

	1 NC / 1 NO	2 NC	1 NC / 1 NO overlapping
Slow-action system	6081000105 IN73-11 AVGU Ro50 	6081000106 IN73-20 AVGU Ro50 	6081000107 IN73-V11 AVGU Ro50
Snap-action system	6081000104 IN73-S11 AVGU Ro50 		

